

# Owner's Manual

INCLUDES

User, Maintenance, Service, and Installation  
Instructions



## Paragon Evolution One Remote



Keep this booklet for service log and future reference

### IMPORTANT

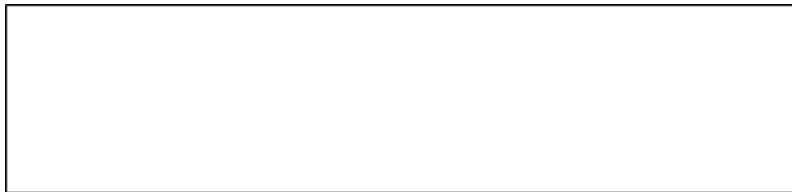

This appliance is guaranteed for 12 months subject to conditions. The 5 year extended parts warranty will only be valid if the annual service recommended in this manual has been completed and appliance has been registered online.

For use in Great Britain and Ireland.

Literature NO 7889 (ISS 1)

## Contents

EXTENDED FIVE YEAR PARTS WARRANTY .....	2
Benchmark Scheme .....	3
<b>SECTION ONE Introduction (user instructions) .....</b>	<b>5</b>
<b>SECTION TWO Operating the Appliance (user instructions).....</b>	<b>8</b>
<b>SECTION THREE Fuel Bed Cleaning and Layout (user instructions).....</b>	<b>10</b>
<b>SECTION FOUR Important Information (user instructions).....</b>	<b>13</b>
<b>SECTION FIVE Specification (installation instructions) .....</b>	<b>14</b>
<b>SECTION SIX Regulations and Warnings (installation instructions).....</b>	<b>15</b>
<b>SECTION SEVEN Siting the Appliance (installation instructions).....</b>	<b>16</b>
<b>SECTION EIGHT Fireplace Requirements (installation instructions).....</b>	<b>17</b>
<b>SECTION NINE To Install the Appliance (installation instructions).....</b>	<b>19</b>
<b>SECTION TEN Maintenance Instructions (maintenance instructions).....</b>	<b>23</b>
<b>SECTION NINE Wiring Diagram (maintenance instructions).....</b>	<b>25</b>
<b>GAS FIRE COMMISSIONING CHECKLIST.....</b>	<b>28</b>
<b>SERVICE RECORD.....</b>	<b>29</b>



## EXTENDED FIVE YEAR PARTS WARRANTY

In order to validate your extended 5 years parts warranty please read the Benchmark Scheme on the opposite page and ensure your installer has filled in the appropriate checklist.

**This in no way reduces your statutory rights**

Your warranty commences from the date of purchase and you must retain your receipt or invoice as proof of a purchase date.

THIS EXTENDED WARRANTY SPECIFICALLY EXCLUDES GLASS AND SOFT REFRACTORY COMPONENTS, THE BULB AND ANY BATTERIES.

### Terms and Conditions

1. The appliance must be installed by a GAS SAFE registered person.
2. The appliance must be used in accordance with the user's instructions.
3. The appliance must be serviced annually by a GAS SAFE registered person.
4. The benchmark and service log must be correctly filled out and the record of annual services must be up to date and supported by receipts in each case.
5. This warranty is not transferable and relates to the original installation only.
6. The appliance has not been subjected to misuse or accident or been modified or repaired by any person other than the authorised employee or authorised representative of Charlton and Jenrick Ltd.
7. The registration form must be returned within 1 month of purchase.

**Technical Help Desk 01952 200 444**



Charlton and Jenrick Ltd is a licensed member of the Benchmark Scheme which aims to improve the standards of installation and commissioning of domestic heating and hot water systems in the UK and to encourage regular servicing to optimise safety, efficiency and performance. Benchmark is managed and promoted by the Heating and Hotwater Industry Council. For more information and the full code of practice please visit [www.centralheating.co.uk](http://www.centralheating.co.uk)

Please ensure that the installer has fully completed the Benchmark Checklist on the inside back pages of the installation instructions supplied with the product and that you have signed it to say that you have received a full and clear explanation of its operation. The installer is legally required to complete a commissioning checklist as a means of complying with the appropriate Building Regulations (England and Wales).

All installations must be notified to Local Area Building Control either directly or through a Competent Persons Scheme. A Building Regulations Compliance Certificate will then be issued to the customer who should, on receipt, write the Notification Number on the Benchmark Checklist.

This product should be serviced regularly to optimise its safety, efficiency and performance. The service engineer should complete the relevant Service Record on the Benchmark Checklist after each service.

The Benchmark Checklist will be required in the event of any warranty.

It is a requirement that the gas fire is installed and commissioned to the manufacturer's instructions and the data fields on the commissioning checklist completed in full.

To instigate the guarantee, the gas fire needs to be registered with the manufacturer within one month of the installation.

To maintain the guarantee, it is essential that the gas fire is serviced annually by a Gas Safe registered engineer. The service details should be recorded on the Benchmark Service Interval Record and left with the householder.

### **Important**

For future reference we suggest you record the following details here, and keep the receipt as proof of purchase. This information may be asked for when you contact the helpdesk.

<b>MODEL:</b>	<b>Paragon Evolution One Remote</b>	<b>Serial No.</b>	
---------------	-------------------------------------	-------------------	--

This information can be found on the label attached to the packaging and on the data badge, which is located on the base of the appliance behind the control cover.

<b>Retailer Name:</b>	
<b>Address:</b>	
<b>Date Of Purchase:</b>	

### **Installer information required to register for the extended warranty**

<b>Name:</b>	
<b>Date of installation:</b>	
<b>Gas safe number:</b>	

## SECTION ONE Introduction (user instructions)

### **Consumer Protection Information**

As manufacturers and suppliers of heating products, we take every care, as far as is reasonably practicable, that these products are so designed and constructed as to meet the general safety requirement when properly used and installed. To this end, our products are thoroughly tested and examined before despatch.

**IMPORTANT NOTICE:** Any alteration that is not approved by the appliance manufacturer could invalidate the approval of the appliance, operation of the warranty and could affect your statutory rights.

### **Health and Safety Notice**

**Important:** This appliance could contain some of the materials, indicated below, that could be interpreted as being injurious to health and safety. It is the users / installers responsibility to ensure that the necessary personal protective clothing is worn when handling these materials, see below for information.

**Artificial Fuels, Mineral Wool, Insulation Material, Refractory/Ceramic Fibres, Glass Yarn** - *may be harmful if inhaled, may be irritating to skin, eyes, nose and throat.*

**When handling** *avoid inhaling and contact with skin or eyes. Use disposable gloves, facemasks and eye protection. After handling wash hands and other exposed parts. If a vacuum is used for cleaning the fuel bed or cleaning after servicing / installation it is recommended that it be of the type fitted with a HEPA filter.*

**Disposal of refractory/ceramic materials.** To keep dust to a minimum these materials should be securely wrapped in polythene and be clearly labelled 'RCF waste'. These materials are not classified as 'hazardous waste and should be disposed of at a site licensed for the disposal of industrial waste.

- This appliance is designed and manufactured to the requirements of EN 509 and is suitable for use in GB (Great Britain) or IE (Ireland).
- This appliance is intended for decorative purposes.
- The appliance is operated via remote control. It is a low voltage battery system; therefore no mains electrical supply is required.
- Like all appliances incorporating an aerated burner a low frequency noise may be heard, this may be more noticeable on the low setting.
- The chimney or flue (unless new) must be swept before installation if it has been used for solid fuel.
- It is advised that this appliance is serviced annually; as it is more likely to provide trouble-free operation.
- This appliance has a naked flame, as with all such fires it is recommended that a fireguard should be used for the protection of children, the elderly and infirm. Fireguards should conform to BS 6539 (1984) (Fireguards for use with solid fuel appliances).
- The appliance incorporates a safety device in the form of an Oxygen Depletion System, which constantly monitors the oxygen in the room and will cause the fire to switch off if the oxygen level reduces, for instance due to insufficient ventilation or a blocked flue. If this regularly occurs do not attempt to relight the appliance until a qualified engineer has checked it, the problem may not be due to lack of air or a defective flue.
- The pilot can be left on (standby setting) or the pilot can be extinguished and relit each time the fire is used.

The PARAGON EVOLUTION ONE REMOTE incorporates a single gas control, which selects ignition pilot, with variable setting between low and high settings. The appliance is operated via a remote control hand set.

The PARAGON EVOLUTION ONE REMOTE is battery operated; therefore no mains electrical supply is required. Power to the appliance is provided by 6 high power alkaline 1.5V batteries (AA size) (a spare set of 6 AA batteries is supplied with the appliance); these batteries can be changed to Nickel Metal Hydride rechargeable batteries providing they have a minimum capacity of 2200 mAh. A set of 6 high power alkaline 1.5V batteries (AA size) would give in the order of 200 - 380 operations while 6 rechargeable batteries when fully charged would give approximately 200-300 operations. These figures are only given for guidance and may vary depending on how the appliance is used and the battery manufacturer and quality.

Using the standby facility when the appliance is switched off for short periods can extend battery life. The standby facility switches off the mains gas supply to the appliance but the pilot remains alight.

An audible repeated bleep warning indicates that the appliance batteries need changing or charging (if rechargeable batteries have been used).

**Important: Batteries should be changed or recharged as soon as possible as the appliance will not light if the battery power gets too low.**

In GB, the appliance must be installed by a competent person i.e. Gas Safe-registered, in accordance with the GAS SAFETY (INSTALLATION AND USE) REGULATIONS, The Building Regulations (or The Building Regulations (Scotland) or The Building Regulations (Northern Ireland)) and The Current I.E.E. Wiring Regulations, if appropriate.

In IE, the appliance must be installed by a competent person and installed in accordance with the current edition of I.S.813 Domestic Gas Installation, the current Building Regulations and the current ETCI rules for electrical installation ,if appropriate.

In the Republic of Ireland, permanent ventilation must be provided in accordance with the regulation in force (I.S. 813).

**It is important that: -**

The chimney or flue is checked annually to ensure clearance of combustion products.

Any purpose-built ventilation should be checked periodically to ensure freedom from obstruction.

Any debris from the chimney or flue should be removed. The fire should be allowed to cool for three to four hours before removing debris.

Rubbish must not be thrown onto the coal/pebble bed under any circumstances.

The cast fire front must be positioned in front of the fire whilst it is burning.

**Warning:-** This appliance has a naked flame, has with all fires it is essential that a fireguard should be used for the protection of children, the elderly and infirm.

Fireguards should conform to BS 6539 (1984) (fireguards for use with solid fuel appliances).

During the normal operation of the fire some black staining may appear on some parts of the fuel bed. This is quite normal and adds to the appearance of the appliance. However, if excessive black staining does occur it may be due to the fuel bed being incorrectly laid. This should be checked against the Fuel Bed Layout in Section Three, prior to contacting a service engineer.

**Pilot Cleaning** (Before cleaning ensure that the appliance is turned off and cold)

In some instances you may experience ignition problems even when the appliance is new. This may be due to the aeration hole in the pilot body (see photograph) being partial blocked with dust, pet hairs or other foreign matter. The source of this debris could be such things as carpet fibres, decorating or pets etc.

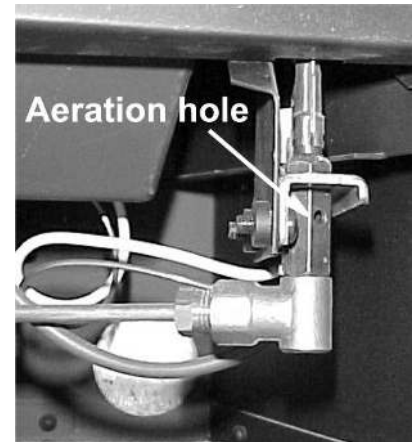

To clean the pilot, remove the fire front and ashpan. The pilot is located on the right hand side of the appliance; any debris in or around the aeration hole should be removed using the nozzle of a vacuum cleaner. It is advisable not to blow the debris into the hole as this may cause more of a restriction and not rectify the problem.

## **Fret**

A Fret must be used with this appliance, and must conform to the following: -

- It must be made from non-combustible material.
- Its general construction should enable it to stand firmly across the full width of the burner.
- The design of the fire front (fret) must have a removable ash-pan cover (lower section).
- The ashpan cover must have cut-outs and or holes which provide ventilation to the underside of the burner.
- The effective area of ventilation through the ash-pan cover must be greater than 1365mm<sup>2</sup> (2.12 sq. ins.)

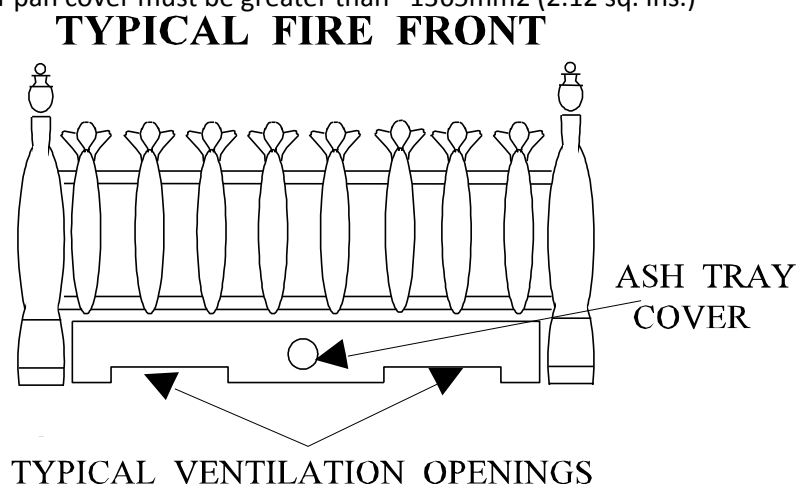

## SECTION TWO Operating the Appliance (user instructions)

**Before attempting to operate the appliance check that nothing has been placed in front of the appliance that may interfere with the remote sensor operation.**

**To light the appliance using the remote hand set:**

- A. Point the remote control hand set in the direction of the appliance and simultaneously press the buttons marked '● off' and 'standby'. Continue to hold in these two buttons until a 'bleep' is heard (approximately 2-3 sec.) and then release these buttons. The appliance will automatically go through the ignition sequence and the pilot should ignite. Once the pilot is alight the appliance will automatically go to the high setting (approximately 20-25sec). If the ignitor stops sparking and the pilot fails to light, repeat this procedure.
- B. The appliance can be adjusted up or down by pressing the appropriate button '🔥' (low setting) or '🔥' (high setting). There are 5 heat settings and the fire will give a double bleep when the maximum or minimum heat setting is reached. To switch off the appliance press the OFF '●' button or if the appliance is to be switch off for a short period it is recommended that the 'standby' button be used. This switches the main burner off but leaves the pilot on and will extend battery life.
- C. The appliance can be switched off with out using the hand set by removing the appliance batteries located behind the ash pan cover. When the batteries are removed there will be a delay (up to 3minutes) after which double bleeps may be heard and shortly after the appliance will extinguish. Ensure that the battery is reconnected once the fire as been extinguished. The appliance cannot be operated without the use of the handset. If the fire fails to light or extinguishes for any reason, it will be necessary to re-set the fire. This can be done by pressing the off '●' button then following the normal lighting procedure.

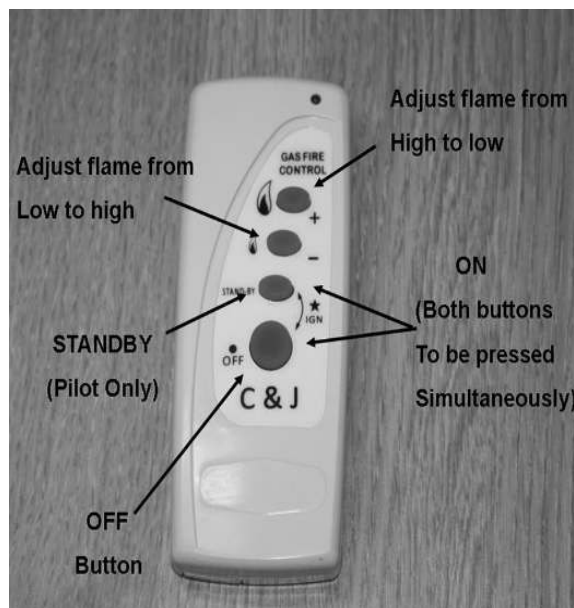

**NOTE: If the fire has extinguished for any reason wait 3 minutes before relighting.**



### Low Battery Indication (Hand Set)

If while pressing any of the buttons on the remote hand set the low battery indicator lamp either stops flashing or appreciably slows then the battery should be changed.

### To Replace Batteries In Hand SET (AAA 1.5 v Ir3 X2 )

Remove the cover from the rear of the handset and fit replacement batteries, taking care not to strain the battery connections.

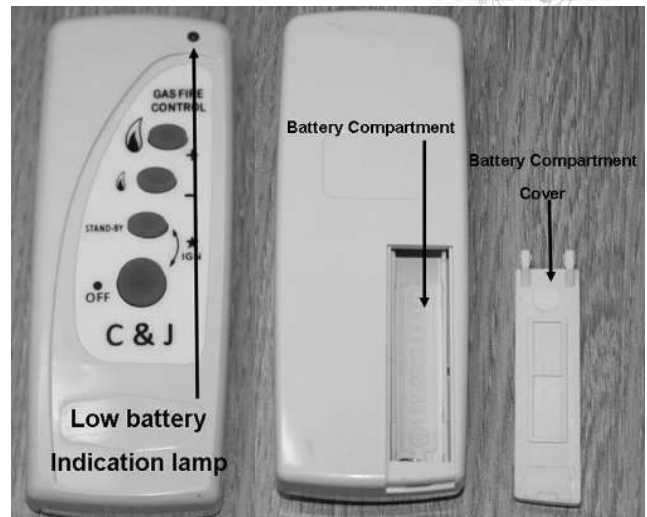

### LOW BATTERY INDICATION (APPLIANCE)

If you hear a repeated 'bleep' sound come from the appliance this indicates the appliance battery pack is low and should be changed as soon as possible. The appliance will continue to work normally for a short period but if the warning is ignored you may experience difficulty lighting the appliance or the appliance may automatically switch off for no apparent reason.

**NOTE:** The appliance cannot be used when the battery is completely flat.

### TO REPLACE APPLIANCE BATTERIES (6 High Power Alkaline AA 1.5V)

**(Rechargeable batteries can be used providing they are a nickel metal hydride type 1.5V AA with a minimum capacity of 2200mAh). Using AA Lithium batteries will give more operations.**

- A. Lift off fret and ash pan.
- B. The battery power pack or holder is located at the left hand side of the burner; carefully slide the battery holder forward and replace all six batteries as a complete set or recharge as appropriate. **WARNING, batteries will overheat if fitted incorrectly, when fitting the batteries ensure that they are fitted as per the marking on the rear of the holder (i.e. minus of battery against spring).** If rechargeable batteries are used they MUST be a Nickel Metal Hydride type with a minimum capacity of 2200mAh.
- C. **Important:** Place the battery pack on the left hand side of the appliance as shown and refit fret and ash pan cover.

## SECTION THREE Fuel Bed Cleaning and Layout (user instructions)

**Important: - Refer to the Health & Safety Notice located on page 5 of this booklet before cleaning or replacing any refractory material.**

The fuel bed components are delicate and they should be handled with great care.

The loose parts may be removed for cleaning. They can be brushed very gently with a soft brush to remove dust or any deposits.

A vacuum cleaner may only be used after the loose components and moulded shapes have been removed.

CARE SHOULD BE TAKEN TO AVOID CONTACT WITH THE REFRACTORY LINING THIS IS A DELICATE SURFACE AND SHOULD **NOT** BE WIPED OR RUBBED.

### FUEL BED LAYOUT (COAL OPTION)

Coal set provided consists of :-

- 9 off shape 'A' coals
- 12 off shape 'B' coals
- 1 off Left hand front coal matrix
- 1 off Right hand front coal matrix
- 1 off Base coal matrix

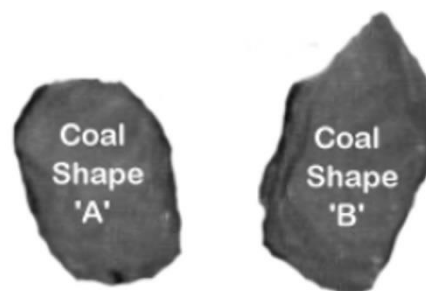

**IMPORTANT: Keep the coals in separate groups for laying on the fire bed.**

- Place the left and right hand front coals onto the front of the burner tray as shown. The front coals must be put on first because the left hand coal is retained in place by the base matrix.
- Place the base matrix behind the front coals as shown
- Pay special attention to make sure that the burner slot is completely clear as shown below

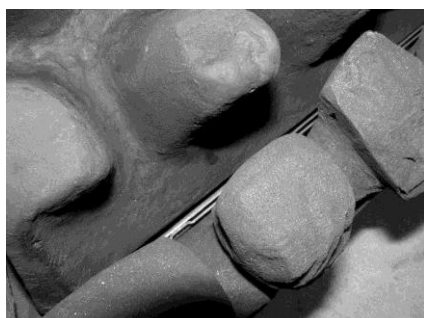

- Place the first row of 3 x A and 3 x B overlay loose coals as shown between the front coals and base matrix. Make sure that they are stable and DO NOT let them fall down in the gaps between the peaks on the matrix.

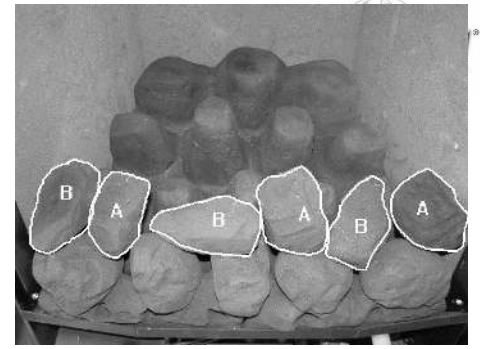

- Add the second row of 3 x A and 2 x B loose coals on to the matrix, resting against the previously placed row of coals and the base matrix. DO NOT allow the coals to fall down the gaps between the matrix peaks.

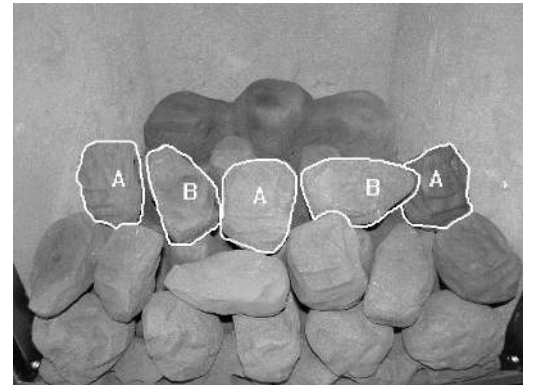

- Add a third row of 2 x A coals and 3 x B coals. DO NOT allow the coals to fall down the gaps between the matrix peaks.

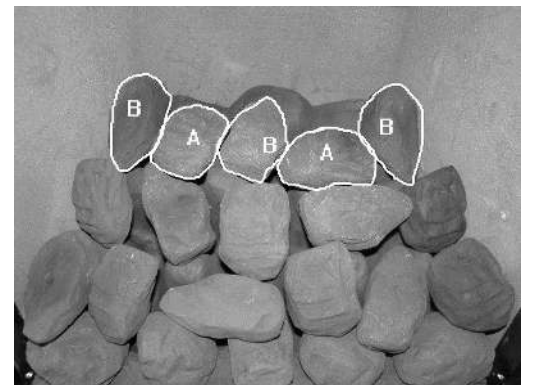

- Add 2 x type B coals at the rear of the coal matrix as shown.

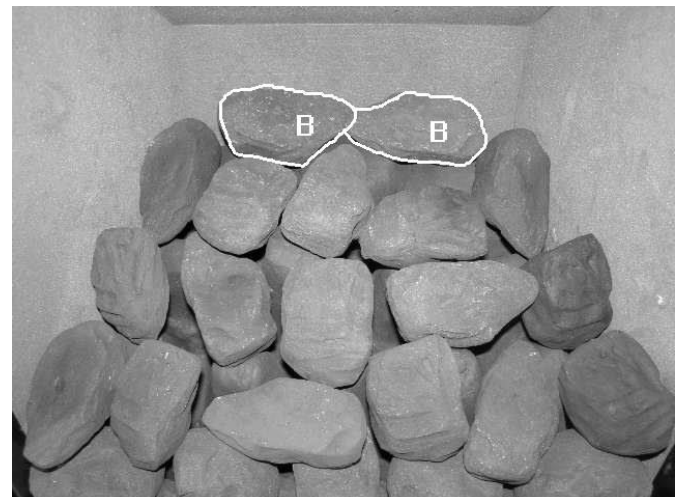

- Add the final 2 x B and 1 x A coals as shown to the top of the coal bed. Arrange so as to be stable. The layout is now finished.

**Note:** Dye is available for touching up coal and liner-board surfaces where the black colouring may have rubbed off in use.

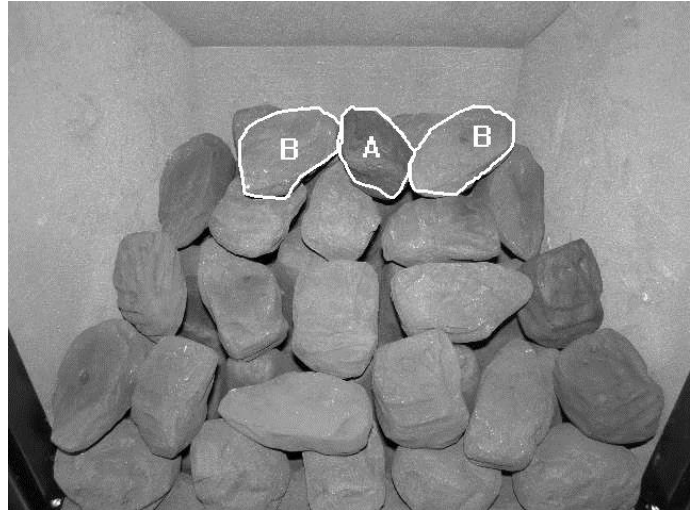

## SECTION FOUR Important Information (user instructions)

The only user removable parts are: -

- The loose coals.
- The baseboards
- Cast Fret
- Decorative Trim

Like all appliances incorporating an aerated burner a low frequency noise may be heard, particularly on the low setting, this is quite normal and does not affect the operation of the appliance.

### **Servicing**

It is advised that the PARAGON EVOLUTION ONE REMOTE fire is serviced annually this is more likely to provide trouble-free operation. A competent person must carry this out, i.e. Gas Safe Registered Installer in accordance with the current Gas Safety (Installation and Use) Regulations 1998 (as amended).

The chimney or flue should be checked annually to ensure clearance of combustion products.

### **Ventilation in the United Kingdom**

This appliance does not normally require purpose-built ventilation but if for any special reason purpose-built ventilation is provided it should be checked periodically to ensure freedom from obstruction.

### **Ventilation in the Republic of Ireland**

Must be permanent ventilation and must comply with the rules in force and should be checked periodically to ensure freedom from obstruction.

### **General Appliance Care**

Any debris from the chimney or flue should be removed from the fuel bed. The fire should be allowed to cool for three to four hours before removing debris.

Rubbish must not be thrown onto the fuel bed under any circumstances. The cast fire front must be positioned in front of the fire whilst it is burning.

## Fret

A Fret must be used with this appliance, and must conform to the following: -

- It must be made from non-combustible material.
- Its general construction should enable it to stand firmly across the full width of the burner.
- The design of the fire front (fret) must have a removable ashtray cover (lower section).
- The ash tray cover must have cut-outs and or holes which provide ventilation to the underside of the burner.

The effective area of ventilation through the ash tray cover must be greater than 1365mm<sup>2</sup> (2.12 sq. ins.)

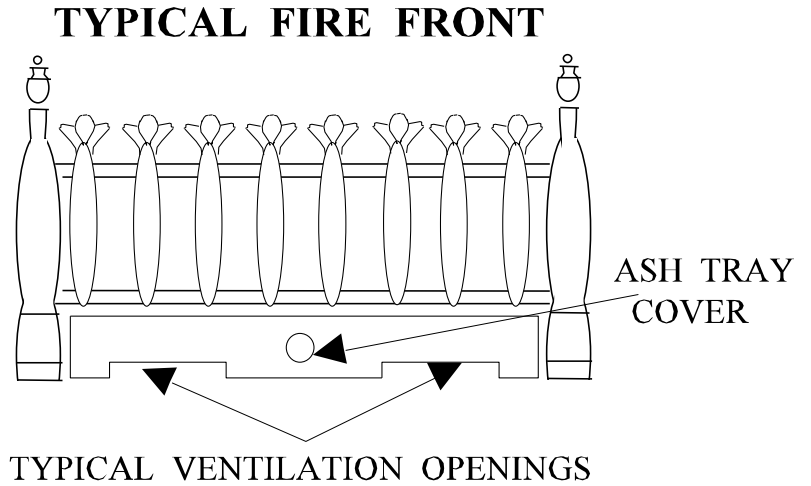

## SECTION FIVE Specification (installation instructions)

Category of Appliance: BA5

Category: I<sub>2H</sub>

Gas type: G20

Gas Pressure: 20mbar

Gas input high: 7.70kW Gross

Gas input low: 2.40kW Gross

Injector Main: Size 770

Oxy-pilot 2900 NG

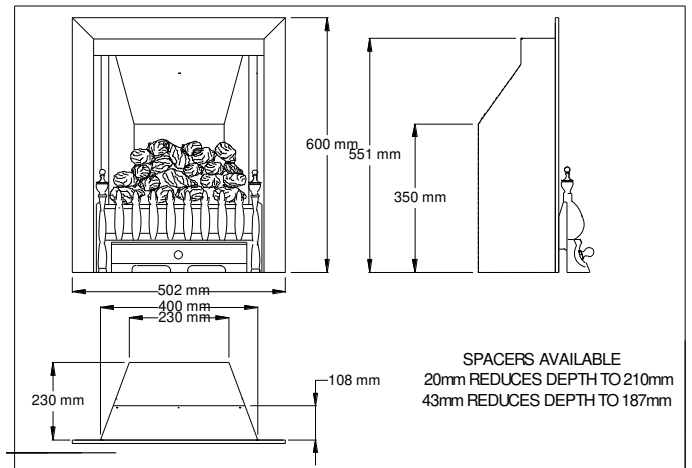

Battery Remote handset 2 X AAA 1.5 V LR 3

Appliance 6 x 1.5V AA high power alkaline or 6 x 1.5 V Rechargeable nickel metal hydride with a minimum capacity of 2200mAh.

Data Label Location: Behind trim

Gas Connection: 8 mm OD Tube

NOTE: The efficiency of this appliance has been measured as specified in BS7977-1 2009 + A1:2013 and the result is 57.0%. The gross calorific value of the fuel has been used for this efficiency calculation. GASTEC have certified the test data from which it has been calculated. The efficiency value may be used in the UK Government's Standard Assessment Procedure (SAP) for energy rating of dwellings.

## SECTION SIX Regulations and Warnings (installation instructions)

- THIS APPLIANCE MUST ONLY BE INSTALLED IN THE GB OR IRELAND.
- Only to be used in sufficiently ventilated room. Read instructions carefully before installation and use. The appliance must be installed by a competent person, i.e.. Gas Safe Registered Installer in accordance with the current Gas Safety (Installation and Use) Regulations 1998 (as amended). Failure to do so could lead to prosecution.
- This PARAGON EVOLUTION ONE REMOTE is for use ONLY with the GAS STATED ON THE DATA BADGE It can be used in conjunction with the following chimneys: -
  - A conventional brick or stone chimney,
  - A metal flue and box conforming to BS 715, further details are covered in later text.
  - A non-combustible hearth must be provided to comply with the building regulations or a suitable proprietary fire surround with a 100 degrees C rating.
- During initial firing an odour may be evident. This is the binder used during the manufacture of the fibre components and there are no harmful effects produced.

The following are the relevant Codes of Practice and British Standards: -

BS 5871	BS 8303
BS 5440 part 1	BS 1251
BS 6891	BS 6461 parts 1 & 2
BS 715	BS 1289 part 1& 2

**Note:- This appliance must be installed to current versions of the above standards and include any relevant amendments.**

The Building Regulations issued by the Department of the Environment

The Building Standards (Scotland) (Consolidation) Regulations issued by the Scottish Development Office.

## SECTION SEVEN Siting the Appliance (installation instructions)

The fire can be installed in the following flues and locations: -

### **CLASS ONE**

A conventional brick or stone chimney as used for a solid fuel appliance with a typical effective cross-sectional dimension of 225 x 225 mm (9 x 9 ins) or a lined flue with a minimum diameter of 125 mm (5 ins). This includes Pre-cast flue systems.

Fireplace opening must be 552 mm - 578 mm high by 400 mm – 458 mm wide (or up to 458 mm if the cable fixing system is used).

The opening depth must be a minimum of 280 mm to allow sufficient volume for debris collection (this depth may be reduced to 250 mm if the chimney is new or has never been used for solid fuel or oil before).

To obtain this depth it may be necessary to remove the chairbrick.

**Note: spacers are available in 20mm and 43mm to further reduce the opening depth if required (if a spacer is used then the thickness of the spacer must be added to the minimum 300mm hearth depth to comply with regulations).**

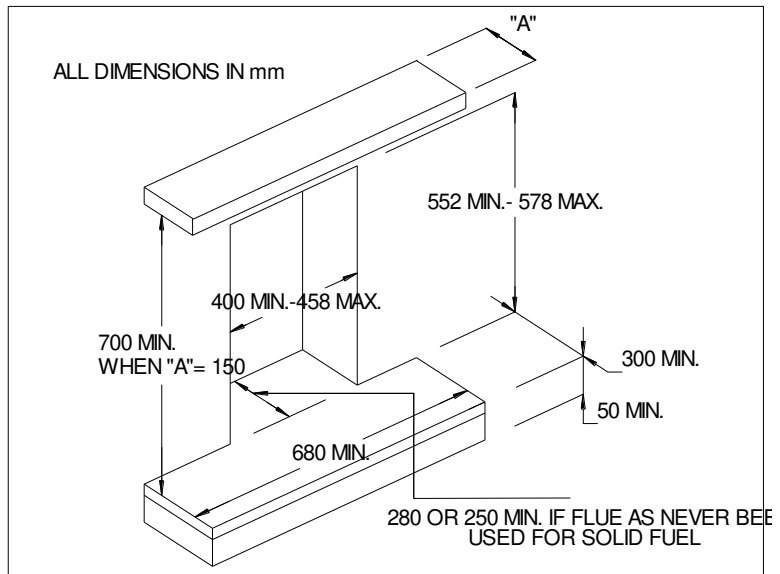

Any permanent flue restriction or variable dampers are to be removed or locked fully open. The chimney should be swept prior to installation if not new.

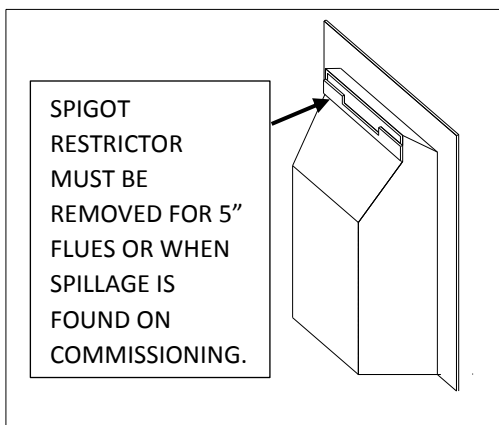

### **CLASS TWO FABRICATED METAL**

A double-walled or insulated metal flue box built to the requirements of BS 715 with an insulated flue having a minimum diameter of 125 mm (5 ins) and a minimum effective overall height of 3 metres (10 ft).

**IMPORTANT: - the flue restrictor plate must be removed when the appliance is installed in this type of flue.**

**Note:** A brick or stone chimney with a 125 mm (5 ins) minimum diameter flue liner conforming to BS 715 may be used. Provided a suitable sealing plate is fitted to the base of the liner and the appliance does not restrict the opening into the liner.

Dampers or register plates must not restrict any of the above flues. The flue must only service a single appliance and not have any branches or traps, which may impede the natural draught. If a terminal is fitted it must be suitable for the purpose.



## SECTION EIGHT Fireplace Requirements (installation instructions)



A flat face of 605 mm high x 500 mm wide must be provided around the fireplace opening for the fixing of the appliance to ensure that a good seal is formed. The base of the fire opening must be flat to ensure sound fixing of the appliance.

A non-combustible hearth must be provided beneath the appliance within the fireplace opening, a fire-resisting hearth must also be provided symmetrically disposed about the fireplace opening a minimum thickness of 12 mm with the perimeter 50mm above floor level. The width must extend a minimum of 150 mm either side of the fireplace opening and a depth of 300 mm (+ thickness of spacer if a spacer is used).

Purpose-built superimposed fire-resistant hearths and back panels, specified as suitable by the manufacturers, may be used, or a suitable proprietary fire surround with a 100°C rating.

### Hole in the Wall Installation

**Please read these instructions carefully if you intend an Installation without a hearth.**

**This appliance must be installed in accordance with all relevant sections of approved document “J” of the building regulations**

It is recommended that a non combustible hearth extends a minimum of 300mm forward of the fire opening and a minimum of 150mm either side, and that a rise exist at the front edge and sides of the hearth of a minimum of 50mm.

The fire may be installed so that its base sits on a surface of a fire opening at least 105 mm up from the floor (*this is to ensure that no flame or incandescent material is less than 225mm above the floor, a requirement of approved document “J”*). Where this is the case a means must be provided to support the fret this may typically be met with a small projecting hearth of minimum 100mm. Unless the fret is fixed to the appliance or is an integral part of the fascia of the appliance.

Consideration should be given to the location of the appliance ensuring it is very visible and it should be positioned at a height were it can clearly be seen on approach.

Frets, and Fascias used for HOLE in the WALL must be compliant with C&J Fires CE approval; these are listed at the end of this page.

Where the fire is fitted as a “Hole in the Wall” without a hearth the installer MUST ensure the appliance is fixed firmly into the opening to ensure no movement takes place to the fuel bed when the appliance controls are operated.

The installer MUST ensure that the fuel bed is laid correctly and securely

The installer **MUST** advise the user that care should be taken when the appliance is in use to ensure occupants **do not** get unnecessarily close to the appliance or position furniture or other appliances to close.

The installer **MUST** remind user of the requirement to fit a “secure fireguard” where the room is used by elderly, infirm or young persons.

The installer **MUST** explain to the user that the area immediately in front of the appliance must always be kept clear of combustible items other than the floor covering (which must be fixed)

In the case of the Pebble fuel bed an alternative layout for “Hole in the Wall” must be followed refer to page 10 in this Manual, this alternative layout **MUST** be adhered to for ALL HOLE in the WALL installations

### **List of approved C&J Frets**

Wellington 2000

Gate

Post

### **CLEARANCE TO SHELF**

Minimum clearance from hearth to underside of combustible shelf should be 700mm provided shelf depth 150mm or less. This height may be reduced to 640mm for a shelf depth of 100mm or less. When the shelf depth is increased by increments of 12.5 mm greater than 150mm, add 25mm to the 700mm minimum clearance.

### **CLEARANCE TO SIDES OF FIRE**

Minimum width between vertical sides of combustible surround should not be less than 700mm provided fire is central to surround and sides do not project more than 150 mm. When vertical side forward projection is increased by 12.5 mm add 50 mm to inside width of surround.

N.B. When fire is fitted this provides a minimum side clearance of 100mm.

Care should be taken to prevent any damage being caused to surrounding soft furnishings or decoration, e.g. many embossed vinyl wall coverings may become discoloured if placed too close to the appliance.

### **VENTILATION**

In the **United Kingdom** no special ventilation bricks or vents are required into the room containing the appliance, provided normal adventitious room ventilation exists. The installer must satisfy this point by carrying out a mandatory spillage test.

In the **Republic of Ireland** permanent ventilation must comply with the rules in force

## SECTION NINE To Install the Appliance (installation instructions)



### **EXAMINE FLUE / CHIMNEY**

Check that the flue/chimney conforms to the required specifications as previously stated. Examine the condition and carry out any remedial work. If the flue/chimney has been used for solid fuel or oil, it should be swept prior to appliance installation. A smoke test must be carried out to check that satisfactory smoke clearance has been established. If all the smoke is not drawn into the flue, pre-heat the flue with a blowtorch or similar and re-check. If there is any uncertainty examine for the cause and, if necessary, seek expert advice.

### **CONNECTING THE GAS SUPPLY**

Determine where the gas supply is to be connected to the appliance. This may be done from the front of the unit from either the left or right side, or a concealed fitting from the rear.

### **GAS CONCEALED CONNECTION**

If the supply is to be a concealed connection it would be advisable to route 8mm O/D half hard copper tube to the rear right side of the fireplace opening, taking into account the requirements of BS 6891 1988 dealing with enclosed pipes. Form the tube so that it enters the fire via the blind grommet at the rear of the appliance. A 8mm restrictor elbow can be positioned under the burner assembly on the right-hand side connected to the gas supply pipe and its outlet connected to the gas appliance.

Note: pipework in the opening of the fireplace to the rear of the appliance must be suitably wrapped in accordance with the regulations.

### **GAS CONNECTION FROM THE FRONT**

Connections may be made from the front of the appliance from either the left or right in 8-mm diameter pipe. If a left-hand connection is required the tube should be routed behind the bezel plate under the gas control tap and onto the inlet elbow. The inlet elbows should be rotated to the required position. A suitable isolating cock should always be fitted in the supply feed to the fire to facilitate servicing.

### **FIXING FIRE INTO OPENING**

Remove the paper backing from the length of foam seal and stick it around the rear flange of fire. If a spacer is going to be used stick the second length (supplied with the spacer kit) around the rear face of the spacer unit, THE FOAM SEAL MUST BE POSITIONED TO ENSURE AN AIR TIGHT SEAL WHEN THE APPLIANCE IS FITTED.

NOTE: -DO NOT USE PERAMENT SEALING COMPOUNDS i.e. SILICONE SEALANT. THIS COULD CAUSE THE APPLIANCE TO BE DAMAGED WHEN IT IS REMOVED FOR SERVICING, AND COULD INVALIDATE THE WARRANTY.

If a spacer is not being used, mark position of flange hole in the fireplace front drill and fix firebox in position with wall plugs and wood screws. If spacer is being used fix the spacer to the fireplace first with wood screws and wall plugs then screw firebox to spacer box using screws provided.

### **OPTIONAL CABLE FIXING SYSTEM (Available on request from C&J FIRES)**

(for use when fixing to 18" openings or when it is desirable not to drill the fireplace fascia) it may **not** be possible to use the cable fixing system with some pre-cast flues.

Drill 4 holes in the rear of the fireplace opening in the position shown and fix securely the 4 eye bolt provided with suitable wall plugs

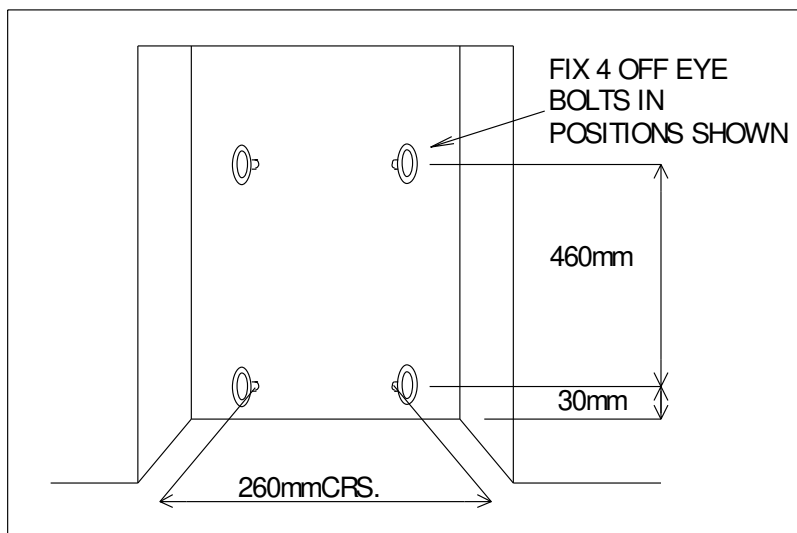

Fix the fire casing back into the opening using the cable fixing system as shown in do not cut off loose ends of cable after fixing, coil and tuck carefully behind sides of Refractory back

Note: when using the cable fixing kit with the spacer, fix and seal the spacer to the rear of the appliance flange with the screws and foam seal provided.

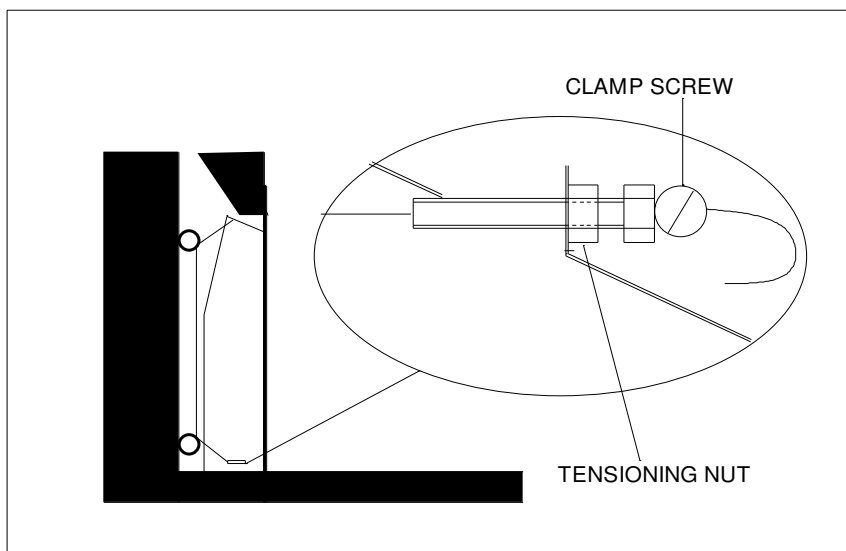

### **CHECKING GAS SOUNDNESS**

**\*Batteries must be connected before proceeding with any soundness testing\***

After completing the gas connection to the appliance, check for gas soundness in accordance with current codes of practice.

### **FUEL BED LAYOUT**

**Important: - Refer to the Health & Safety Notice located on page 5 of this booklet before cleaning or replacing any refractory material.**

Lay fuel bed as shown in the Users Section of these instructions.

**ENSURE THE FUEL BED IS PLACED AS INDICATED IN THESE INSTRUCTIONS.**

## **POSITIONING REMOTE CONTROL EYE**

Note: - The remote control eye is fixed to the front of the control fascia using a self adhesive clip.

In some instances (e.g. when an alternative fret or ash pan cover is used) it may be necessary to reposition the remote control eye, an alternative position is specified below.

- Position the remote control eye as shown with the front edge level with the ash pan cover.
- Secure in position with insulation tape as shown. Position the tape at the rear of the eye do not place any tape over the eye as this may cause receiving problems.
- Connect battery pack to appliance and insert batteries (supplied).
- Reposition ash pan cover.
- Fit 2 X AAA 1.5 V (supplied) to remote hand set (see Section 2).
- Check that a signal is being received by pointing the remote control hand set in the direction of the appliance and simultaneously press the buttons marked '●' and 'standby'. Continue to hold in these two buttons until a 'bleep' is heard (approximately 2-3 sec.). If no sound is heard check position of remote control eye.

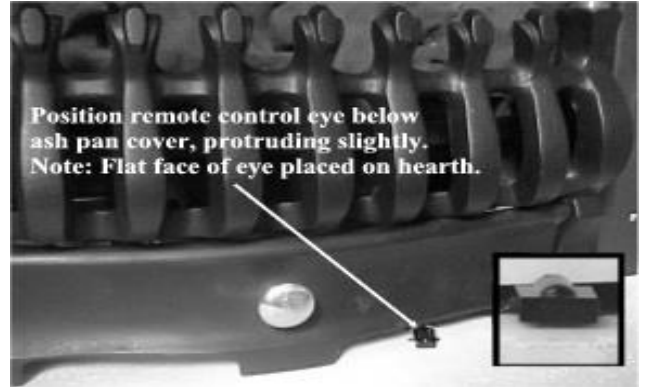

## **CHECKING OPERATION OF FIRE**

- Remove ash pan cover.
- Remove the screw from the pressure test point on the inlet elbow and fit pressure gauge.
- Turn on the gas to the appliance.
- Purge the air from the appliance by operating the appliance (see Section 2). The appliance will spark for approximately 20 seconds at which point if no ignition is detected the appliance will go to lock out and you must repeat the ignition procedure.
- Check that the electrode is sparking at the gap between the thermocouple tip and the electrode and that the pilot ignition is established. After approximately 20 seconds the main burner will light on the high setting.
- Check the inlet pressure is  $20 \pm 1$  mbar for Natural Gas (G20).
- Refit pressure test point screw and check for leaks.
- Refit ash pan cover.

## **CHECKING PRODUCT CLEARANCE**

Check for satisfactory clearance of combustion products. Close all doors and windows and leave fire burning for 5 minutes. Then position a smoke match just into the top of the fire opening and move it left and right, all the smoke must be drawn into the flue. If spillage occurs, allow a further 5 minutes. Should spillage still occur, remove appliance restrictor plate if still fitted and repeat spillage test. If spillage still occurs turn off the fire and seek expert advice.

If an extractor fan is situated in the room this test should be repeated with the fan running. If there is a connected room with an extractor fan, the test should be repeated with all the doors to that room opened and the extractor fan running.

## **COMPLETION OF INSTALLATION**

Fit the decorative trim with the four magnetic strips placed two on each vertical side flange of the firebox - one at the top and one at the bottom. Offer the decorative trim up squarely and centrally and push back into position.

Position a suitable fire fret up to the front of the appliance ensuring that it meets the specification referred to earlier.

Demonstrate the lighting and extinguishing procedures to the user and the removal and refitting of the decorative trim and fret for cleaning.

## **ADVISE CUSTOMER THAT:**

- This appliance has a naked flame, as with all such fires it is recommended that a fireguard should be used for the protection of children, the elderly and infirm. Fireguards should conform to BS 6539 (1984) (Fireguards for use with solid fuel appliances).
- The curing effect of heating the fuel bed and other Refractory components will cause an initial odour. This is due to the starch used in the manufacturing process and is non-toxic.
- Any debris should be cleaned from the appliance. A vacuum cleaner can be used but only after all the loose components have been removed. The appliance should be serviced annually by a competent person in accordance with these instructions and the appliance checked for spillage in accordance with the method detailed in these instructions.

**Hand these instructions over to the user.**

**Important: - Refer to the Health & Safety Notice located on page 5 of this booklet before cleaning or replacing any refractory material.**

- Servicing should be carried out annually by a competent person such as a Gas Safe-registered person in accordance with the relevant regulations, to ensure the safe and correct operation of the appliance.
- Before commencing any service or replacement of parts, turn off the main gas supply and disconnect transformer from power supply. After servicing check for gas soundness.
- When ordering spare parts please quote appliance name and serial number, these can be found on the data badge, which is located on the flange behind the decorative fire trim.
- At least once a year, check for debris in the catchment area behind the fire and in the flue way.
- If soot has accumulated check to establish cause, rectify and clean flue or chimney accordingly.
- Examine the fuel bed components for signs of cracking and replace if necessary. (IMPORTANT) The loose fuel bed components should only be replaced as a complete set with no extra or different components used.

### **FUEL BED CLEANING**

**Important: - Refer to the Health & Safety Notice located on page 5 of this booklet before cleaning or replacing any refractory material.**

The loose fuel bed components are delicate and they should be handled with great care. They may be removed for cleaning. They can be brushed very gently with a soft brush to remove dust or any deposits. A vacuum cleaner may only be used after the loose components have been removed.

### **REPLACEMENT OF GAS CONTROL**

1. Turn off the gas supply by the isolating cock.
2. Remove fire fret.
3. Remove all loose fuel bed components and base boards.
4. Disconnect battery leads and remove appliance battery pack. Detach remote control eye from hearth. (See Section Nine when repositioning.)
5. Remove 4 screws fixing burner unit into the casing and to the back support.
6. Disconnect fire at inlet elbow and remove burner unit from the casing.
7. Disconnect the thermocouple from the rear of the gas valve.
8. Undo the three compression nuts securing the pipes to the gas valve and remove the two screws fixing the valve to the bracket.
9. Clean, service or replace gas valve.
10. Re-assemble in the reverse order.
11. Turn on the gas supply, check for soundness and recommission appliance.

### **REPLACEMENT OF INJECTOR**

1. Repeat operations 1-3 for removal of gas control.
2. Undo the two screws retaining the burner and lift the burner out.
3. Lift away the silencer; noting its position the cut out slot pointing down, it must be put back in exactly the same orientation.
4. Unscrew the locking nut fixing injector to mounting bracket and silencer retaining bracket clean or replace as necessary.
5. Re-assemble the in reverse order and check assembly for gas soundness.
6. Turn on gas supply, check for gas soundness and recommission appliance.

## **Replacement of Oxy-Pilot Assembly**

**NOTE:** If the pilot assembly is replaced it must be replaced by an identical unit from the same manufacturer and replaced as a complete unit it is a NON SERVICABLE ITEM.

- Repeat operations 1-6 for removal of gas control.
- Disconnect the pipe from the gas control to the pilot burner
- Disconnect the thermocouple connection from the rear of the gas control.
- Remove ignition lead from pilot assembly.
- Remove the two screws securing the oxy-pilot to the burner.
- Before replacing ensure the code number for Oxy-Pilot replacement is suitable.
- Re-assemble the in reverse order and check assembly for gas soundness.
- Turn on the gas supply, check for gas soundness and recommission appliance

## **REPLACEMENT OF CONTROL UNIT (EDB)**

1. Repeat operations 1-7 for removal of gas control.
2. Disconnect leads from control unit and remove 2 bolts. If necessary release pilot pipe from control valve to clear box when removing.
3. Re-assemble in the reverse order.
4. Turn on the gas supply, check for gas soundness and re-commission appliance.



## SECTION NINE Wiring Diagram (maintenance instructions)

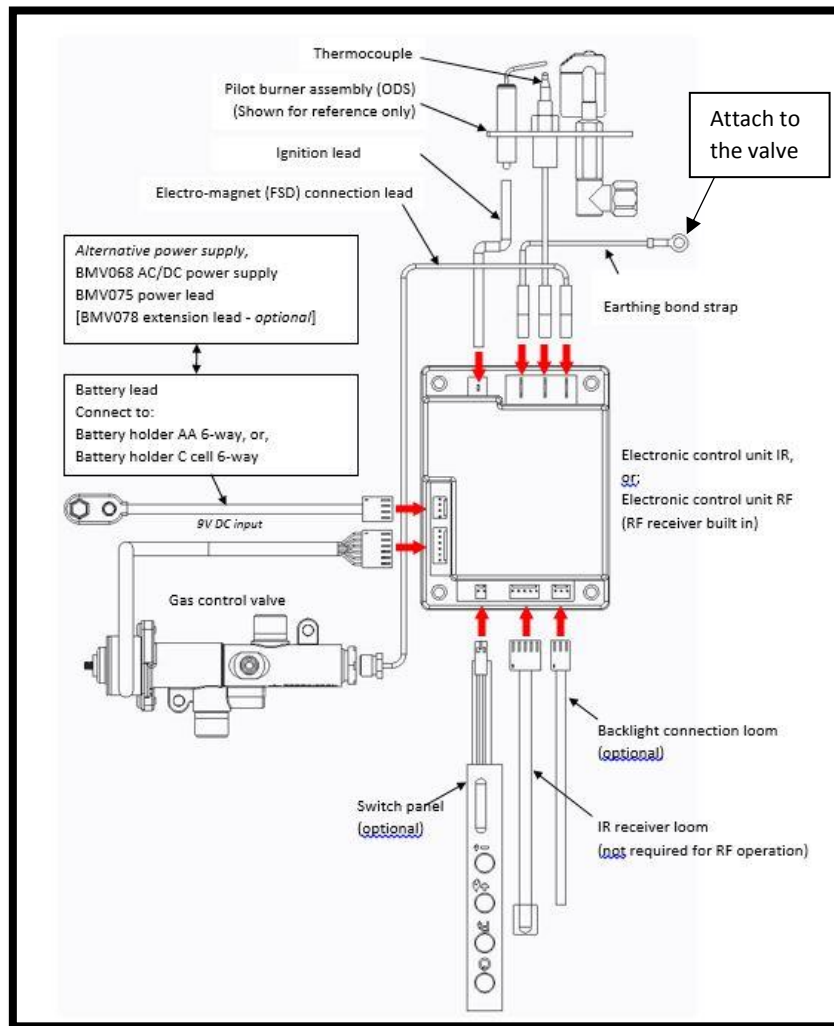



## Register your appliance online today to active your warranty



## GAS FIRE COMMISSIONING CHECKLIST

This Commissioning Checklist is to be completed in full by the competent person who commissioned the gas fire as a means of demonstrating compliance with the appropriate Building Regulations and then handed to the customer to keep for future reference.

Failure to install and commission according to the manufacturer's instructions and complete this Benchmark Commissioning Checklist will invalidate the warranty. This does not affect the customer's statutory rights.

Site Requirements	Yes	N/A
Was the chimney checked to ensure it only serves one flue/fire, has no obstructions and is continuous?		
Has any debris at the base of the chimney been removed?		
For brick chimney installations is there enough depth for 12 litres of debris, or precast flues 2 litres of debris? (see instructions for debris gap details)		
Have damper and register plates been removed or locked in the fully open position ensuring correct size of flue is maintained?		
If previously used for solid fuel has the chimney been thoroughly swept?		
If the chimney is pre-cast has the inside of the flue been checked for extruded cement / sealant which must be removed?		
Has the fire place been checked for under-floor air supply which must be sealed off?		
Has the chimney been inspected prior to fitting the gas fire to ensure that it is in good condition?		
Has the structure of the chimney been checked for leakage using a smoke pellet test? (See BS5440-1 for details).		
<b>Ventilation</b>		
Does the installation require any additional ventilation requirements as detailed in the manufacturer's instructions?		
<b>Hearth Requirements- where fitted</b>		
Is the hearth constructed from non -combustible material?		
Is the hearth a minimum of 12mm thick with a minimum floor to top surface of 50mm?(BS5871) or as per manufacturer's instructions?		
Is the hearth for open fronted fires a minimum of 760mm wide and has 300mm projecting from the fire opening (BS6871) or to manufacturer's instructions?		
Mounting height (where applicable) has the fire been installed to the correct mounting height- as per manufacturer's instructions?		
<b>Firebox and Fuel Bed</b>		
Has the fuel bed, coals, pebbles etc. been fitted to manufacturer's instructions?		
<b>Gas Supply</b>		
Has an isolation tap/restrictor inlet elbow been fitted for servicing?		
Has the gas supply been thoroughly purged prior to connection to remove any debris?		
Has a gas tightness test been completed prior to breaking into the gas supply and following completion of installation?(IGEM/UP/1B)		
Record burner gas pressure reading? If only the supply pressure is available a gas rate must be undertaken.(GSIUR REG26/9C)		
Record dynamic inlet gas pressure (working pressure) reading (all gas appliances running)		
<b>Spillage test</b>		
Installation passes smoke match test with any extractor fans turned on (see manufacturer's instructions)		
<b>Installation</b>		
Has the gas fire been installed and commissioned in accordance with manufacturer's instructions?		
Has the fire been installed with the correct clearance to combustible materials, as per manufacturer's instructions?		
The operation of the appliance and controls have been demonstrated to the customer including battery replacement where applicable?		
The manufacturer's literature, including Benchmark Checklist and Service record has been explained and left with the customer?		
Has the appliance been registered with the Local Authority as detailed on the Gas Safe web site and is a legal requirement and forms part of the warranty?		
Customer's Signature: (To confirm satisfactory demonstration and receipt of manufacturer's literature)	Commissioning Engineer's Signature:	

\*All installations in England and Wales must be notified to be Local Authority Building Control (LABC) either directly or through a Competent Persons Scheme. A Building Regulations Compliance Certificate will then be issued to the customer.

# SERVICE RECORD



**It is essential that your gas fire is serviced regularly and that the appropriate Service Interval Record is completed. Service Provider**

Before completing the appropriate Service Record below, please ensure you have carried out the service as described in the manufacturer's instructions. Always use the manufacturer's specified spare part when replacing controls.







<b>SERVICE 01</b>	Date:
Engineer name:	
Company name:	
Telephone No:	
Gas safe register No:	
Comments:	
Signature	

<b>SERVICE 02</b>	Date:
Engineer name:	
Company name:	
Telephone No:	
Gas safe register No:	
Comments:	
Signature	

<b>SERVICE 03</b>	Date:
Engineer name:	
Company name:	
Telephone No:	
Gas safe register No:	
Comments:	
Signature	

<b>SERVICE 04</b>	Date:
Engineer name:	
Company name:	
Telephone No:	
Gas safe register No:	
Comments:	
Signature	

<b>SERVICE 05</b>	Date:
Engineer name:	
Company name:	
Telephone No:	
Gas safe register No:	
Comments:	
Signature	

Product ID Label	A-0715	Serial No Prefix	SM
Fire Box Labels: Restrictor Plate Spillage (Text) Data Badge			
Fire Box Grommet 			
Burner Tray / Box Assembly			
Warning Label (Fire Guard)			
Cable Clips(1 Alum) 			
Boxed Coal Set (4613)			
Fixing (0705) eye bolt    foam strip    screw    magnets    wall plug     			
Qty 4    Qty 1    Qty 4    Qty 4    Qty 4			
Restrictor Elbow (male) 			
AAA Batteries x 2 			
Remote Control (Hand Set) 			
Battery Holder 			
Remote Quick Ref Card (6713)			
AA Batteries (12) 			
Owners Book			
ID Label & Packing Labels			
Serial Number			
Inspector			