

# Owner's Manual

INCLUDES

User, Maintenance, Service, and Installation Instructions



\*\*\*\*\* WARNING !!!!! TRANSIT BOLTS MUST BE REMOVED BEFORE INSTALLING \*\*\*\*\*

**P5 BF**



Keep this booklet for service log and future reference

## IMPORTANT



This appliance is guaranteed for 12 months subject to conditions. The 5 year extended parts warranty will only be valid if the annual service recommended in this manual has been completed and appliance has been registered online.

## Contents

EXTENDED FIVE YEAR PARTS WARRANTY .....	2
Benchmark Scheme .....	3
SECTION ONE Important Information .....	5
SECTION TWO Introduction (user instructions) .....	7
SECTION THREE Operation (user instructions) .....	7
SECTION THREE Operation (user instructions) .....	8
SECTION FOUR Cleaning & Laying the fuel bed (user instructions).....	9
SECTION FIVE Appliance Data (installation instructions).....	17
SECTION SIX Regulations and Warnings (installation instructions).....	18
SECTION SEVEN Siting the Appliance (installation instructions).....	19
SECTION EIGHT Preparing the Appliance for Installation (installation instructions) .....	20
SECTION NINE CONNECTING THE GAS SUPPLY (installation instructions) .....	22
SECTION NINE Commissioning the appliance (installation instructions) .....	23
SECTION TEN Assemble the appliance (installation instructions).....	23
SECTION ELEVEN Instruct and Advise the Customer (installation instructions) .....	24
SECTION TWELVE Maintenance Instructions (maintenance instructions) .....	24
SECTION THIRTEEN Wiring Diagram (maintenance instructions).....	27
Short Spare list .....	28
BALANCED FLUE GAS FIRE COMMISSIONING CHECKLIST .....	30
SERVICE RECORD.....	31



## EXTENDED FIVE YEAR PARTS WARRANTY

In order to validate your extended 5 years parts warranty please read the Benchmark Scheme on the opposite page and ensure your installer has filled in the appropriate checklist.

**This in no way reduces your statutory rights**

Your warranty commences from the date of purchase and you must retain your receipt or invoice as proof of a purchase date.

THIS EXTENDED WARRANTY SPECIFICALLY EXCLUDES GLASS AND SOFT REFRACTORY COMPONENTS, THE BULB AND ANY BATTERIES.

### Terms and Conditions

1. The appliance must be installed by a GAS SAFE registered person.
2. The appliance must be used in accordance with the user's instructions.
3. The appliance must be serviced annually by a GAS SAFE registered person.
4. The benchmark and service log must be correctly filled out and the record of annual services must be up to date and supported by receipts in each case.
5. This warranty is not transferable and relates to the original installation only.
6. The appliance has not been subjected to misuse or accident or been modified or repaired by any person other than the authorised employee or authorised representative of Charlton and Jenrick Ltd.
7. The registration form must be returned within 1 month of purchase.



## Benchmark Scheme

Charlton and Jenrick Ltd is a licensed member of the Benchmark Scheme, which aims to improve the standards of installation and commissioning of domestic heating and hot water systems in the UK and to encourage regular servicing to optimise safety, efficiency, and performance. Benchmark is managed and promoted by the Heating and Hot water Industry Council. For more information and the full code of practice, please visit [www.centralheating.co.uk](http://www.centralheating.co.uk)

Please ensure that the installer has fully completed the Benchmark Checklist on the inside back pages of the installation instructions supplied with the product and that you have signed it to say that you have received a full and clear explanation of its operation. The installer is legally required to complete a commissioning checklist as a means of complying with the appropriate Building Regulations (England and Wales).

All installations must be notified to Local Area Building Control either directly or through a Competent Persons Scheme. A Building Regulations Compliance Certificate will then be issued to the customer who should, on receipt, write the Notification Number on the Benchmark Checklist.

This product should be serviced regularly to optimise its safety, efficiency, and performance. The service engineer should complete the relevant Service Record on the Benchmark Checklist after each service.

The Benchmark Checklist will be required in the event of any warranty.

It is a requirement that the gas fire is installed and commissioned to the manufacturer's instructions and the data fields on the commissioning checklist completed in full.

To instigate the guarantee, the gas fire needs to be registered with the manufacturer within one month of the installation.

To maintain the guarantee, it is essential that the gas fire be serviced annually by a Gas Safe registered engineer. The service details should be recorded on the Benchmark Service Interval Record and left with the householder.

**Important**

For future reference, we suggest you record the following details here, and keep the receipt as proof of purchase. This information may be asked for when you contact the helpdesk.

<b>MODEL:</b>	<b>PARAGON P5 B.F.</b>	<b>Serial No.</b>	
---------------	------------------------	-------------------	--

This information can be found on the label attached to the packaging and on the data badge, which is located on the base of the appliance behind the control cover.

<b>Retailer Name:</b>	
<b>Address:</b>	
<b>Date Of Purchase:</b>	

**Installer information required to register for the extended warranty**

<b>Name:</b>	
<b>Date of installation:</b>	
<b>Gas safe number:</b>	

## SECTION ONE Important Information

### **Consumer protection information**

As manufacturers and suppliers of heating products, we take every care, as far as is reasonably practicable, that these products are so designed and constructed as to meet the general safety requirement when properly used and installed. To this end, our products are thoroughly tested and examined before despatch.

**IMPORTANT NOTICE:** Any alterations that are not approved by the appliance manufacturer could invalidate the approval of the appliance, operation of the warranty and could affect your statutory rights.

### **Health and safety notice**

#### **Important**

This appliance could contain some of the materials, indicated below, that maybe be interpreted as being injurious to health and safety. It is the users / installers responsibility to ensure that the necessary personal protective clothing is worn when handling these materials, see below for information.

**Artificial Fuels, Mineral Wool, Insulation Material, Refractory/Ceramic Fibres, Glass Yarn** - *may be harmful if inhaled, may be irritating to skin, eyes, nose and throat.*

**When handling** *avoid inhaling and contact with skin or eyes. Use disposable gloves, facemasks and eye protection. After handling wash hands and other exposed parts. If a vacuum is used for cleaning the coals or cleaning after servicing / installation it is recommended that it be of the type fitted with a HEPA filter.*

**Disposal of refractory/ceramic materials.** *To keep dust to a minimum these materials should be securely wrapped in polythene and be clearly labelled 'RCF waste'. These materials are not classified as 'hazardous waste' and should be disposed of at a site licensed for the disposal of industrial waste.*

## INTRODUCTION

- The PARAGON P5 BF is an inset room sealed decorative fuel-effect gas appliance.
- The PARAGON P5 BF is available in Natural Gas only.
- The PARAGON P5 BF must not be installed into a natural draught flue or chimney.
- The PARAGON P5 BF should only be installed and serviced by a competent person i.e. GAS SAFE registered, in accordance with the GAS SAFETY (INSTALLATION AND USE) REGULATIONS.
- The PARAGON P5 BF does not require a chimney but must be installed against an outside wall.
- It is important that the flue terminal is regularly always checked and kept clear.
- If the terminal is accessible to people (i.e. less than 2m above a walkway, balcony etc.)
  - a terminal guard must be fitted to prevent access to the flue outlet, which becomes hot when the fire is in use.
- As the PARAGON P5 BF is a room-sealed appliance, (i.e., air for the combustion process is taken from outside the room) no purpose-built ventilation is required.
- The PARAGON P5 BF is designed and tested to meet the requirements of the European Standard EN 613.

The power supply for this appliance is provided via AC power adaptor 230 VAC. The main cable terminates at the rear middle of the firebox. The length of the cable provided with the appliance is 1.65 metres. Care must be taken when siting the firebox not to trap the exposed main cable within the builders opening. Like all appliances incorporating an aerated burner a low frequency noise may be heard, this may be more noticeable on the low setting. To obtain an authentic fire sound, a noise maybe noticeable from the burner.

Note: the power cable link to the transformer must be accessible for re-pairing handset and use with the battery holder.

## **IMPORTANT INFORMATION**

- The Appliance is for use on Natural Gas (G20 @ 20mbar ) only.
- Failure to install appliance correctly could lead to prosecution.
- Relief Flap Transit bolts must be removed from the top of the appliance before installation.

**In GB (Great Britain)**, the appliance must be installed by a competent person i.e. GAS SAFE registered, in accordance with the GAS SAFETY (INSTALLATION AND USE) REGULATIONS, The Building Regulations (or The Building Regulations (Scotland)) and The Current I.E.E. Wiring Regulations, if appropriate.

- Although the Paragon P5 BF is fitted with a glass front which acts as a dress guard it is strongly recommended that a fireguard should be used for the protection of children, the elderly or infirm. Fireguards should conform to B. S. 6539 (1984) (Fireguards for use with solid fuel appliance).
- Care should be taken to prevent any damage being caused to surrounding soft furnishings or decoration. Many wall coverings may become discoloured if placed too close to the appliance, it is strongly recommended that any proposed wall covering intended for use immediately above the appliance should be tested in the hottest position (immediately above) first. Run the fire on high over a few days
- All combustible material must be removed from behind the fire and fire trim.
- The first time you light your new appliance a smell may occur due to its new condition. This is quite normal and will soon disappear after a few hours use at maximum setting (open a window until the smell disappears)
- With use, the inside of the air box will change colour, particularly the sides and rear. This is quite normal and often adds to the overall effects of the appliance.
- The appliance **MUST NOT** be used if the glass panel is not correctly fitted or if this panel is cracked or broken.
- Any debris should be cleaned from the appliance. A vacuum cleaner can be used but only after all the loose shapes have been removed.
- ***Prior to removing or cleaning the coals refer to the 'Health and Safety Notice' located on page 3 of this booklet.***
- The appliance should be serviced annually by a competent person i.e., a **GAS SAFE registered engineer** in accordance with these instructions.
- The glass or any part of the appliance **MUST NOT** be cleaned or wiped whilst the appliance is **HOT**, to do so could be dangerous and may damage the paintwork of the appliance.
- Check with the supplier or manufacturer that the surround meets 150°C minimum rating (attention should especially be given to manmade materials such as resin).

## SECTION TWO Introduction (user instructions)

- The PARAGON P5 BF is an inset room sealed decorative fuel-effect gas appliance designed for use in locations that do not have a conventional chimney. The appliance must be installed against an outside wall because the air to support combustion is taken from the outside and the products of combustion are expelled to the outside.
- The appliance incorporates a safety device in the form of a FLAME SUPERVISION DEVICE, which constantly monitors the flame and will cause the gas to be switched off if the flames are extinguished for any reason. **THIS DEVICE MUST NOT BE OVERRIDDEN.** If this situation occurs on a regular basis, have the appliance checked by a qualified engineer. The problem may be due to a blocked or restricted flue.
- Before removing the trim, glass and ceramic shapes for cleaning the fire should be turned off, and left to cool down.
- **NOTE:** In use some discoloration of the components will take place in the combustion box, this is normal, but can be kept to a minimum if the shapes are placed correctly (i.e., after cleaning). See Section 4.
- As with all heating appliances certain areas (Working Surfaces) become very hot when the appliance is in use.



## SECTION THREE Operation (user instructions)

Before attempting to operate the appliance check that nothing has been placed in front of the appliance that may interfere with the remote sensor operation.

To light the appliance using the remote handset:

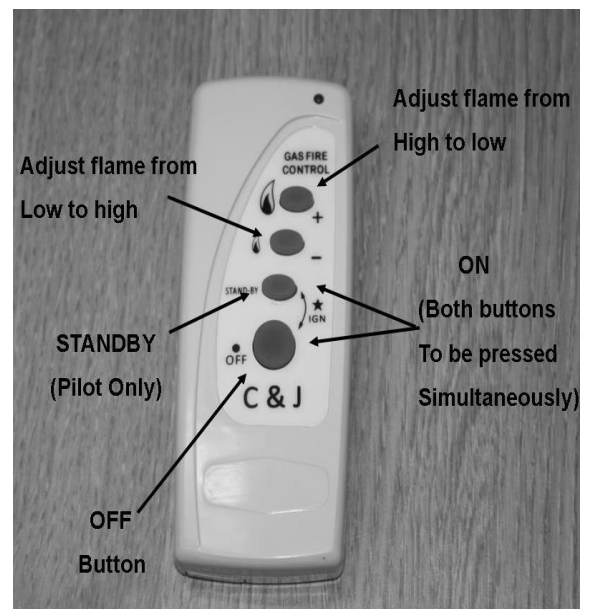
- Point the remote-control handset in the direction of the appliance and simultaneously press the buttons marked 'off' and 'standby'. Continue to hold in these two buttons until a 'bleep' is heard (approximately 2-3 sec.) and then release these buttons. The appliance will automatically go through the ignition sequence and the pilot should ignite. Once the pilot is alighting the appliance will automatically go to the high setting (approximately 20-25sec). If the ignitor stops sparking and the pilot fails to light, repeat this procedure.
- The appliance can be adjusted up or down by pressing



the appropriate button  (low setting) or  (high setting). There are 5 heat settings, and the fire will give a double bleep when the maximum or minimum heat setting is reached. To switch off the appliance press the OFF  button or if the appliance is to be switch off for a short period it is recommended that the 'standby' button be used. This switches the main burner off but leaves the pilot on and will extend battery life.

- The appliance can be switched off without using the handset by unplugging the transformer. When the transformer is removed there will be a delay (up to 3minutes) after which double bleeps may be heard and shortly after the appliance will extinguish. Ensure that the transformer is reconnected once the fire as been extinguished. The appliance cannot be operated without the use of the handset. If the fire fails to light or extinguishes for any reason, it will be necessary to re-set the fire. This can be done by pressing the off  button then following the normal lighting procedure.

**NOTE: If the fire is extinguished for any reason wait 3 minutes before relighting.**

**Note: if repeated delayed ignition is experienced during start-up, it is recommended that the appliance is checked by a gas safe engineer**

## SECTION THREE Operation (user instructions)

### Low Battery Indication (Handset)

If while pressing any of the buttons on the remote handset the low battery indicator lamp either stops flashing or appreciably slows then the battery should be changed.

### To Replace Batteries In Handset (AAA 1.5v LR3 x 2 )

Remove the cover from the rear of the handset and fit replacement batteries, taking care not to strain the battery connections.

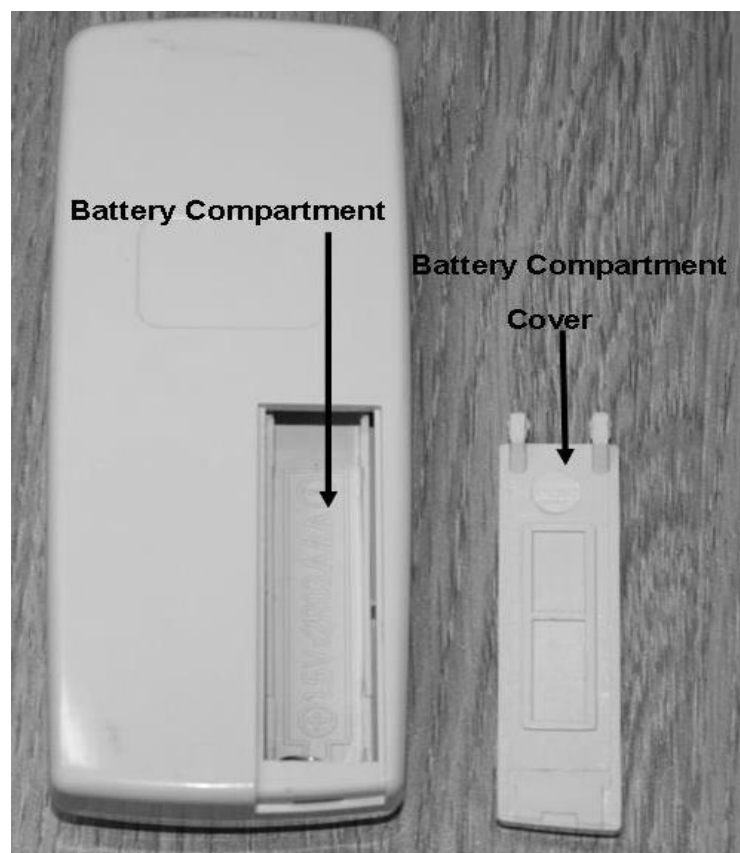



## SECTION FOUR Cleaning & Laying the fuel bed (user instructions)

**Warning:**-Before you clean any part of the appliance ensure that the appliance is switched off and cool.

### CLEANING: BLACK PAINTED SURFACES

- These surfaces should be dusted regularly, and any marks removed with a soft cloth.
- Abrasive or chemical cleaner should never be used.

### CLEANING: GLASS PANEL

From time to time, it may be necessary to clean the glass panel.

We recommend you use a Ceramic Hob Cleaner (brands such as **HOB BRITE** and **VITRO CLEN** have been found to be **acceptable**) these are available from most leading Supermarkets.

Remove the glass panel as follows:

- Carefully lift out the Inner Frame

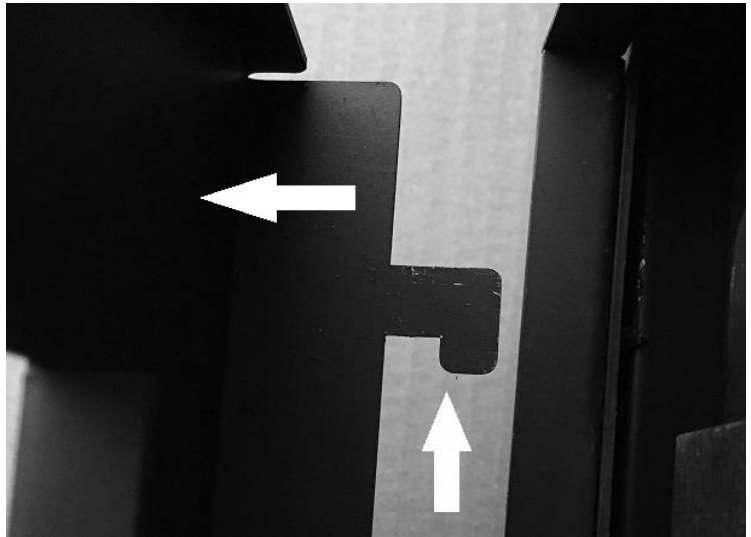

- Remove the three fixing brackets located on the top and sides of the glass panel.
- Remove the 3 x nuts on each of the Glass Clamps leaving the top Clamp till last, remember to hold the Glass Panel back when removing the nuts.
- Carefully lift the glass panel up out off the bottom location. Lay the glass panel down on a flat working surface on top of an old, opened newspaper with the side to be cleaned uppermost.

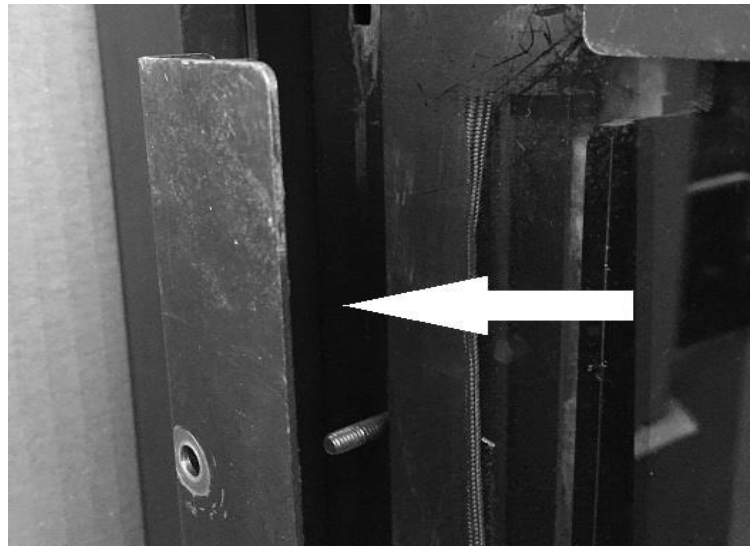

### **Follow the Instructions on the Hob Cleaner Bottle.**

On stubborn stains (where the appliance has been used for a long period without glass panel being cleaned), use a new **Brillo Pad** well wetted with the Hob cleaner applied directly to it.

Ensure all the residues of the cleaner are removed with a damp cloth and the glass panel is completely dry before fitting to the appliance. Take care to not over-tighten the glass nuts, as this will result in the glass cracking. Glass is not covered by warranty

Note: - If the loose shapes have not been placed correctly, causing the gas flame to contact the glass this may result in glass staining that cannot be removed by cleaning.

- Re-assemble in reverse order ensuring a tight seal against the Glass Panel.

### **IMPORTANT!!!**

Make sure that the Rope Seal is evenly spaced and not pushed out by the glass panel especially in the Bottom Channel

- Re-fit the Inner Frame.

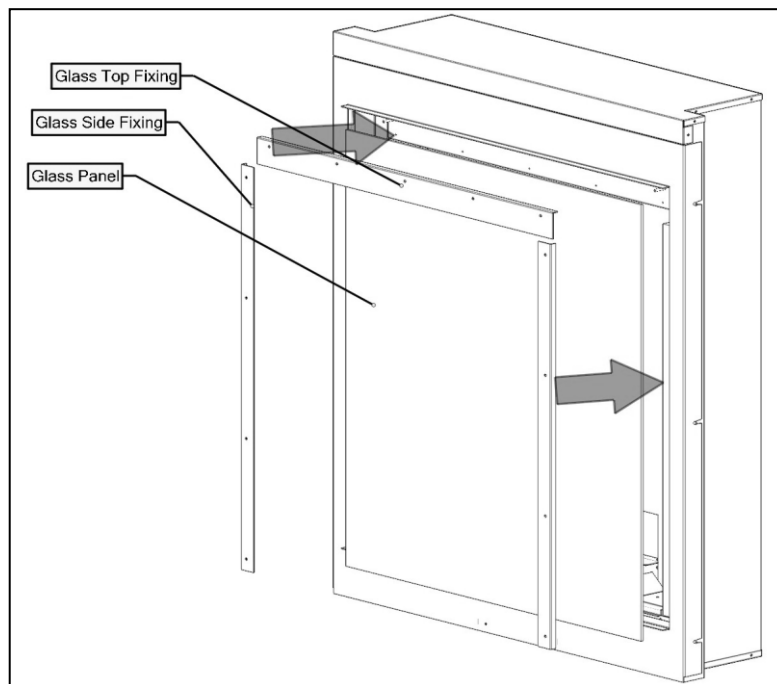

### **CLEANING AND REPLACING fuel bed shapes**

**Important:** - Refer to the 'Health & Safety Notice located on page 3 of this booklet before cleaning or replacing any refractory material.

Use only the shapes provided **NO OTHER SHAPES SHOULD BE ADDED** to the appliance

### **The Fuel bed set consists of:**

- 12 Log Shapes.
- 1 x Bag of Vermiculite
- 1 x Packet of Embaglow

**Log Fuel Bed Layout.**

Within this packed appliance is one packet of Embaglow. Only part of the packet should be used per install, the spare part of the pack is provided for the first annual service. Failure to place the correct number of flakes and in the correct burner area can result in producing a poor flame picture and sooty deposits.

**Log Fuel Bed Layout**

- Place the Front Infill with the holes & slots facing downwards, avoid damaging the pilot assembly.



- Place shape No. 1 on the pins on the Burner as shown .



- Place a thin single layer of Vermiculite over the Burner as shown, avoid laying it too thick

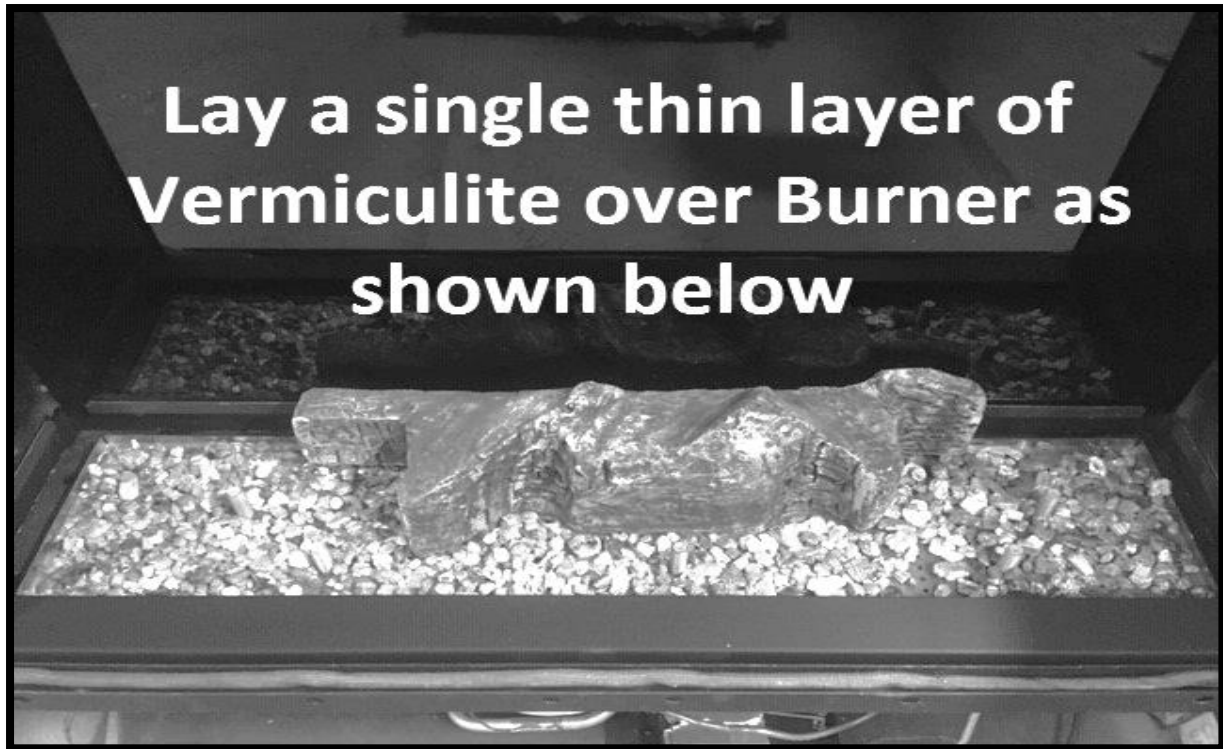

- Make sure not to block around the pilot area on the Burner and Front Infill cover, if flakes fall in, it may be worth lifting the Infill grill out carefully and removing , before carrying on with laying the shapes.

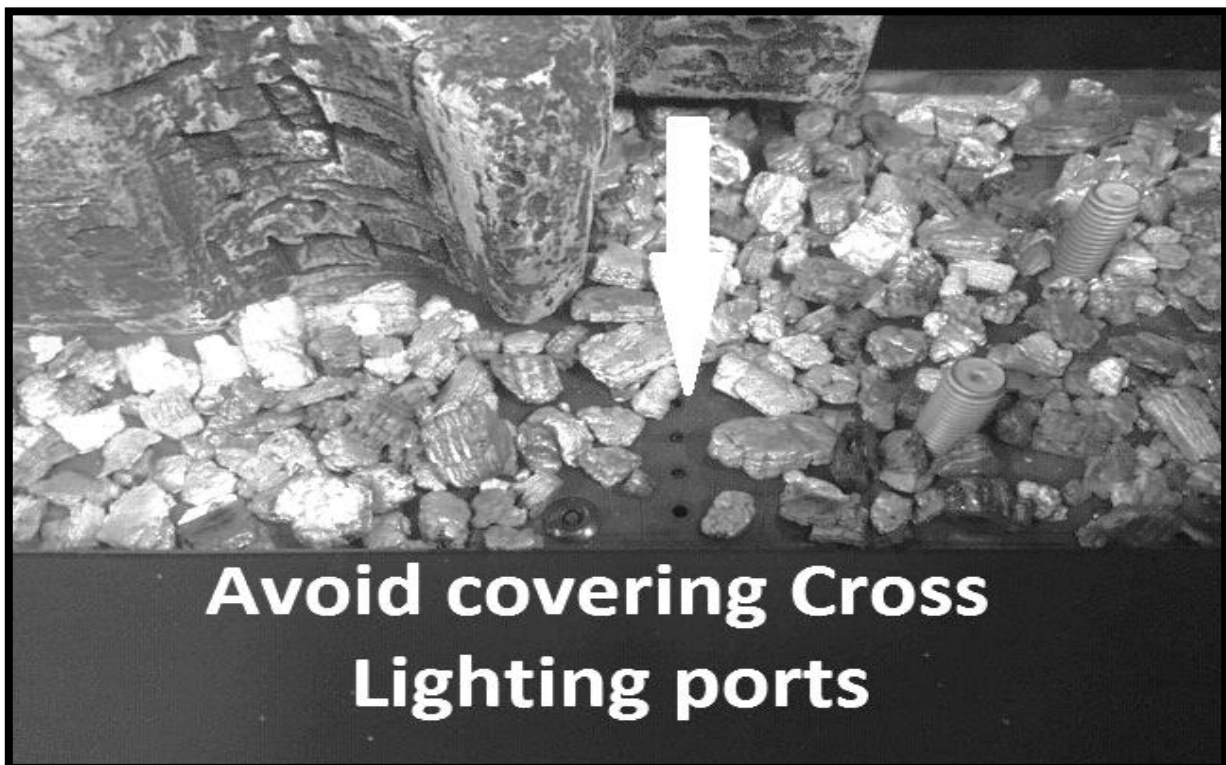

- Place shapes No. 2, 3, & 4 on the pins as shown.

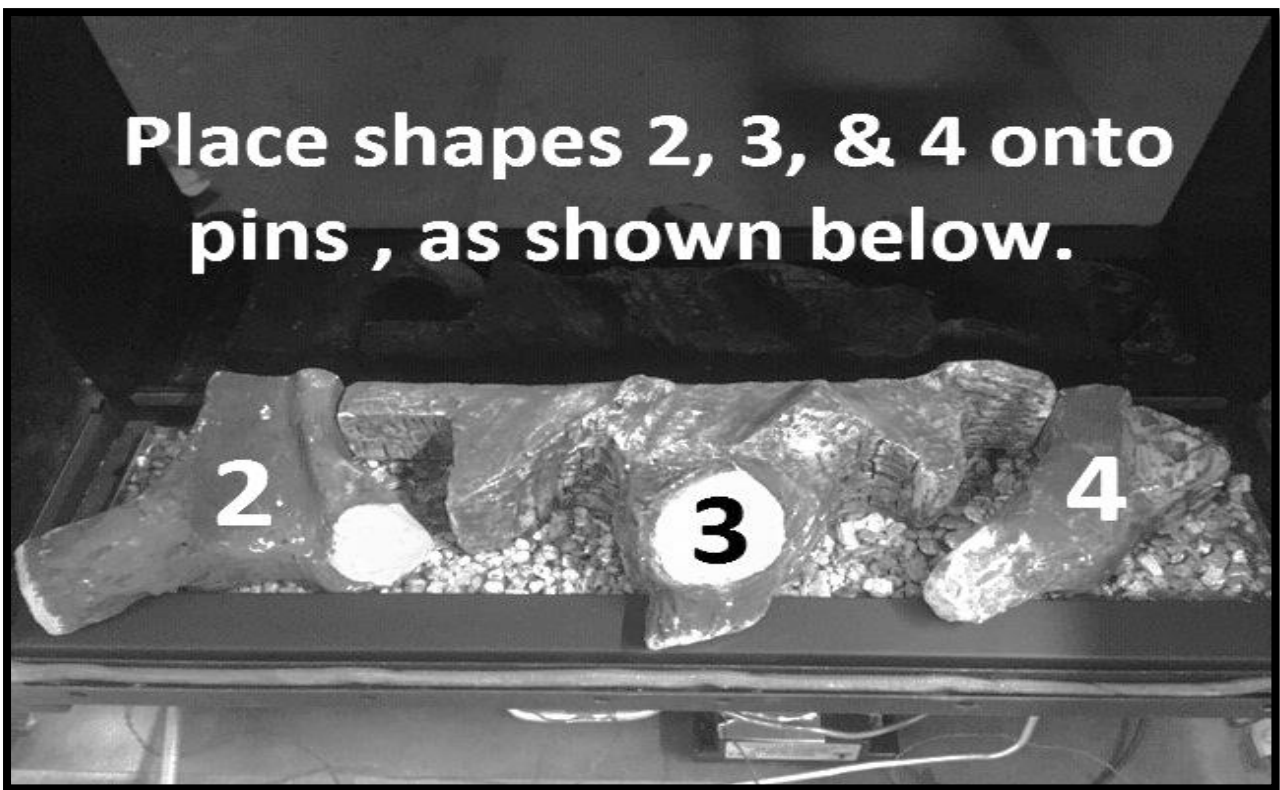

- Place shape No.5 on the Burner and Front infill cover, making sure it sits upright as shown.

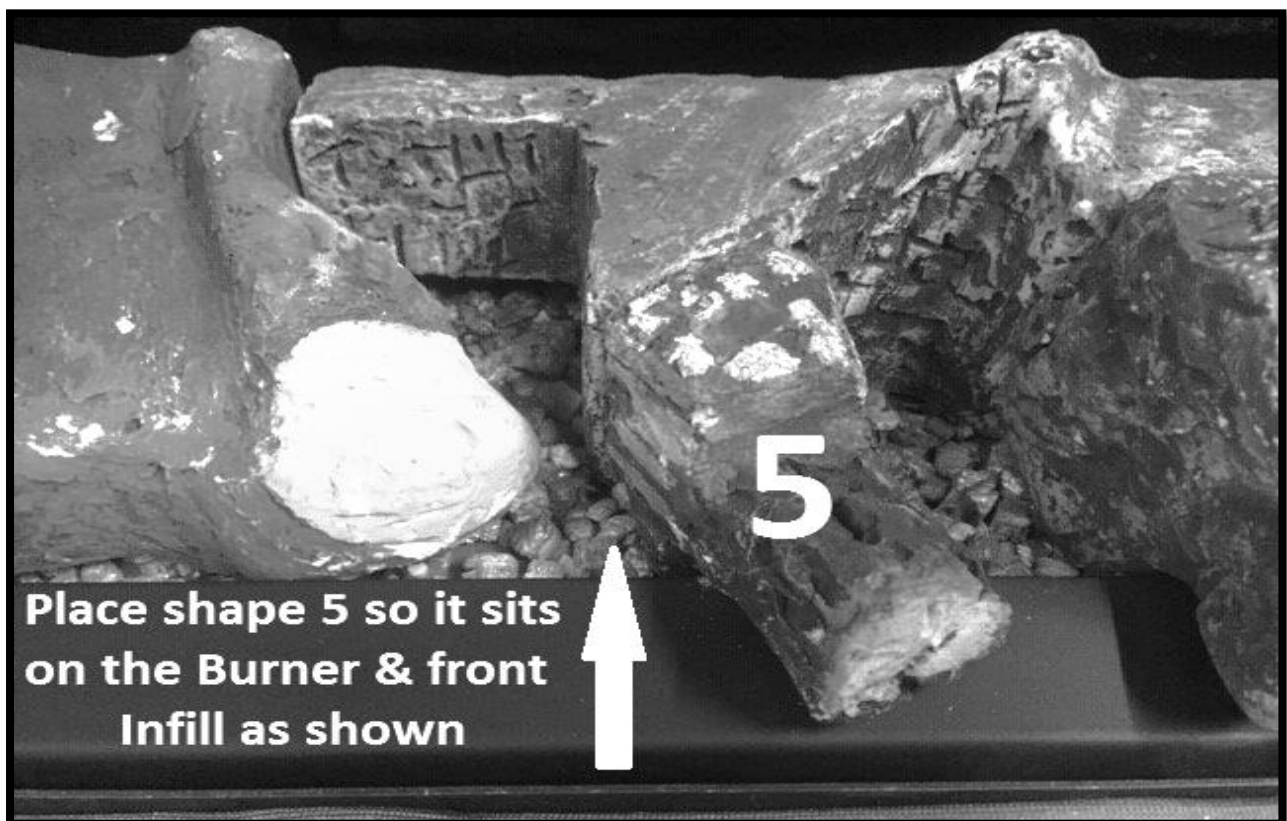

- Tease out 6 x small pieces of Embaglow from the packet , keep the rest for annual servicing , the smaller and looser the pieces the better, as this will give a more even glow, less soot and a better flame picture.



- Place 2 of the small pieces of Embaglow in between the shapes on the Left Hand side as shown.

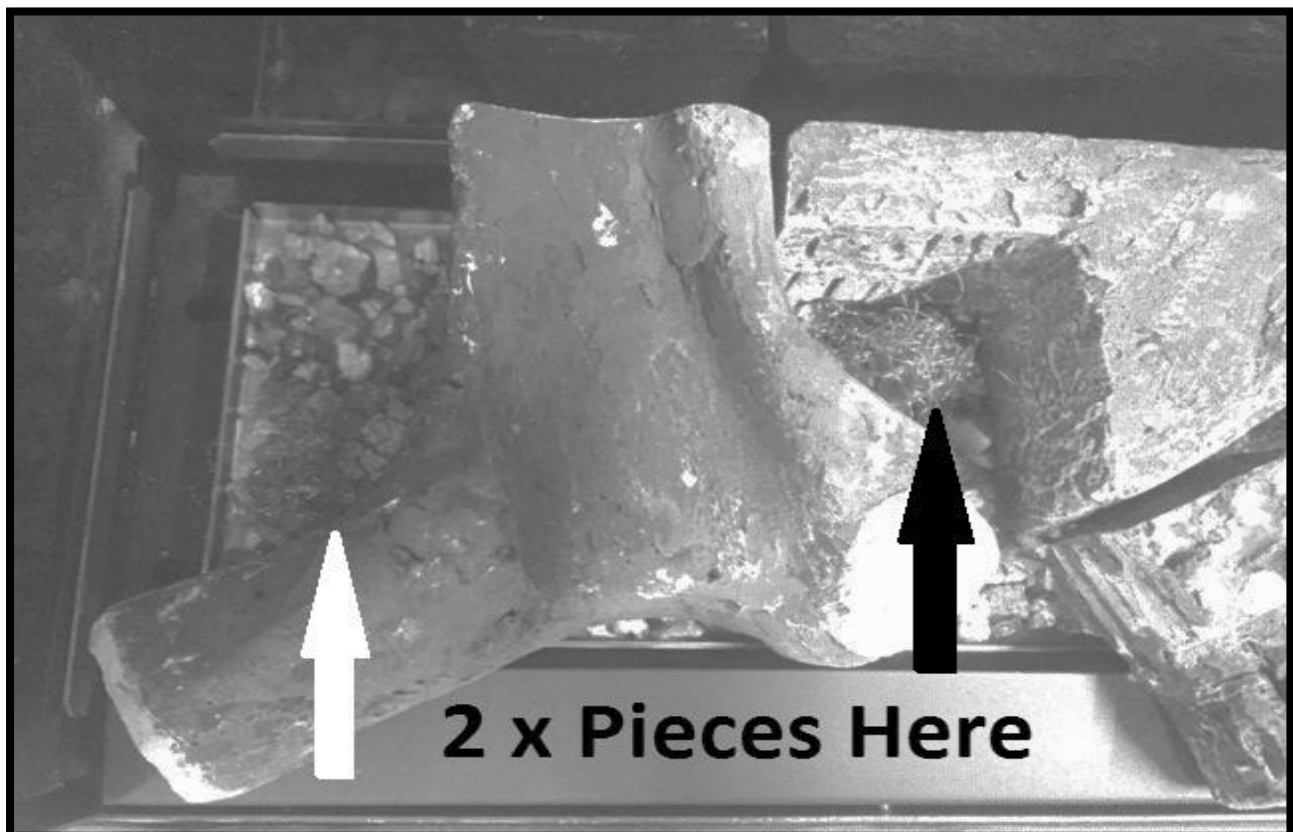

- Place a further 2 pieces of the Embaglow in between the shapes on the Right Hand side as shown.

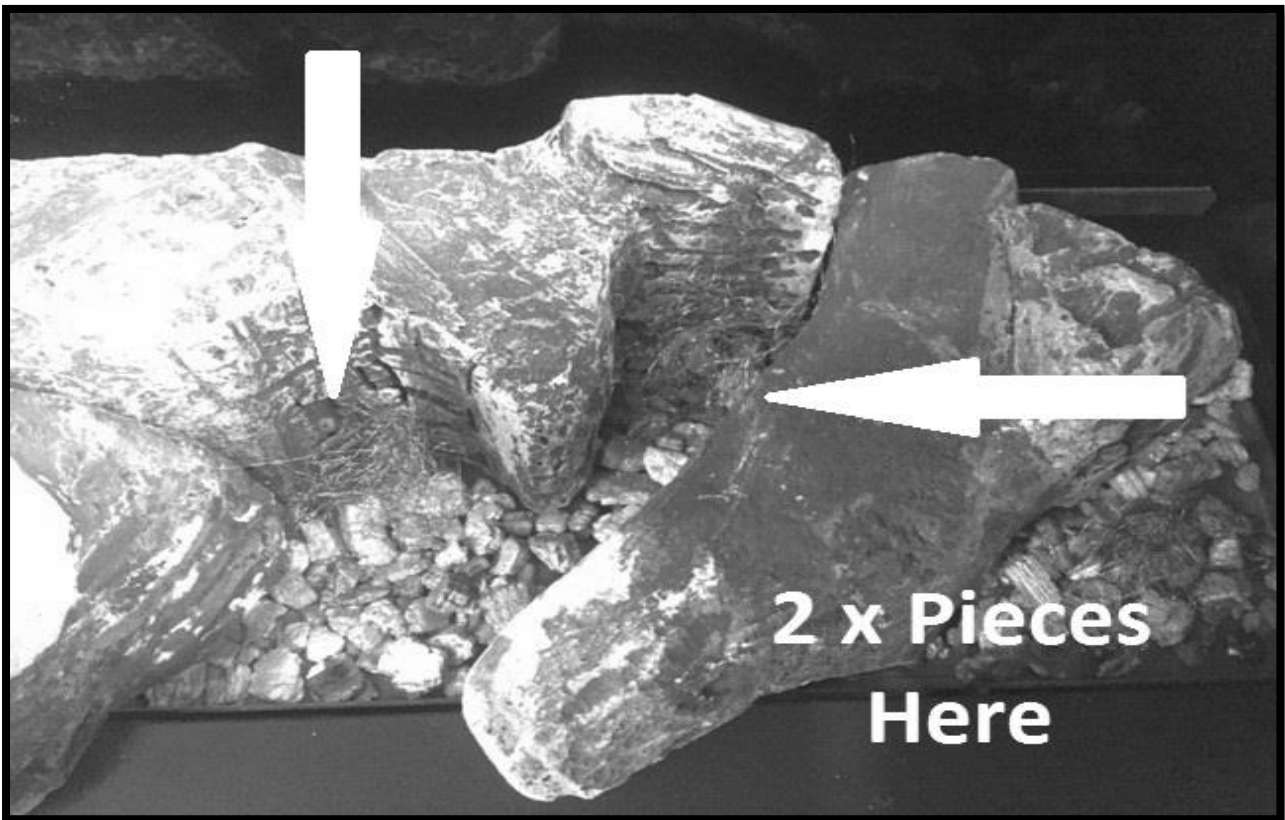

- Place shapes No. 6, 7, 8, & 9 on top of the logs and the last two remaining pieces of the Embaglow between the shapes as shown.

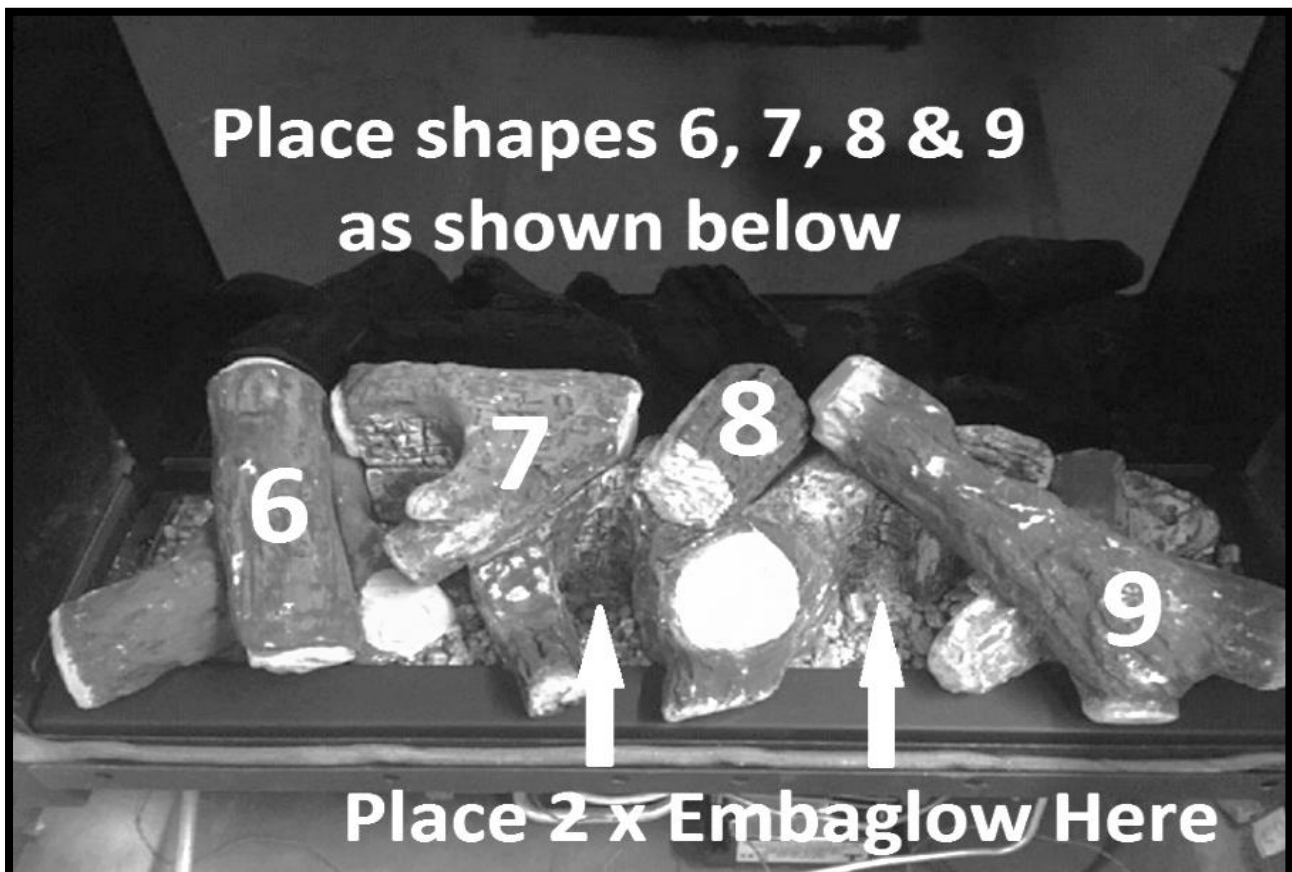

- Place shapes No. 10, 11, & 12 on top of the logs as shown.





## SECTION FIVE Appliance Data (installation instructions)

Fire Box dimensions: ..... Height 922mm

Width 705mm

Forward Projection: ..... 45mm

Weight: ..... 35kg

Flue Length.....100mm (minimum) to 600mm (maximum)

No bends or joined flue pipes should be used in the flue system.

Pressure Test Point Location: ..... Gas inlet elbow

Gas Connection: ..... 8.0mm O/D, tube.

Data Badge Location: ..... On bottom right hand side of firebox below inlet grill.

<b>MODEL</b>	<b>Natural Gas (G20) Version</b>
Category of appliance	C <sub>II</sub>
NO <sub>x</sub> Class	4
Efficiency Class	1
Gas Category	I <sub>2H</sub>
Gas Type	G20 Natural Gas
Gas Pressure +/- 1.0mbar	20 mbar
Gas Input (Max)	7.4 kW Gross
(Min)	3.8 kW Gross
Injectors size	770 Mark

NOTE: The efficiency of this appliance has been measured as specified in BS EN613-2001 and the result is 77.4% natural gas. The gross calorific value of the fuel has been used for this efficiency calculation. Gastec have certified the test data from which it has been calculated. The efficiency value may be used in the UK Government's Standard Assessment Procedure (SAP) for energy rating of dwellings.

## SECTION SIX Regulations and Warnings (installation instructions)

- This appliance must only be installed in Great Britain.
- The appliance is available in natural gas only.
- This appliance must be installed on a suitable outside wall.
- No special ventilation bricks or vents are required into the room containing the appliance.
- **In GB (Great Britain)**

It is the law that all gas appliances must be installed by a competent person, i.e. a GAS SAFE registered installer, in accordance with the current Gas Safety (Installation and Use) Regulations (as amended), all relevant parts of the local and national building regulations and all relevant recommendations of the current British Standards. Failure to do so could lead to prosecution.

The following are the relevant codes of practice and British Standards: -

B.S. 5871 PART 2

B.S. 5440 PART 1

B.S. 6891

B.S. 1945

Note: - This appliance must be installed to current versions of the above standards and include any relevant amendments.

The Building Regulations issued by The Department of the Environment.

The Building Standards (Scotland) (Consolidated) Regulations issued by The Scottish Development Office.

### WARNINGS

#### **\*\*\* RELIEF FLAP TRANSIT BOLTS MUST BE REMOVED BEFORE INSTALL \*\*\***

- As this appliance has components, which get very hot as with all such fires, it is recommended that a fireguard should be used for the protection of children, the elderly, or the infirm. Fireguards should conform to B.S.6539 (1984) (Fireguards for use with solid fuel appliances).
- During initial use, an odour may be evident. This will soon disappear if the fire is run on its maximum setting for a few hours.
- Care must be taken to prevent any damage being caused to surrounding soft furnishing or decoration, e.g. wall coverings may become discoloured if placed too close to the appliance.

## SECTION SEVEN Siting the Appliance (installation instructions)

### GENERAL REQUIREMENTS

- The flue and air duct length must be between 100mm to 600mm.
- The fire is supplied with a standard pipe length of 600mm Flue length.
- The flue and air duct must not have any bends.
- The flue outlet must terminate on a suitable outside wall.
- The minimum flue terminal clearances, which must be maintained, are as shown below.

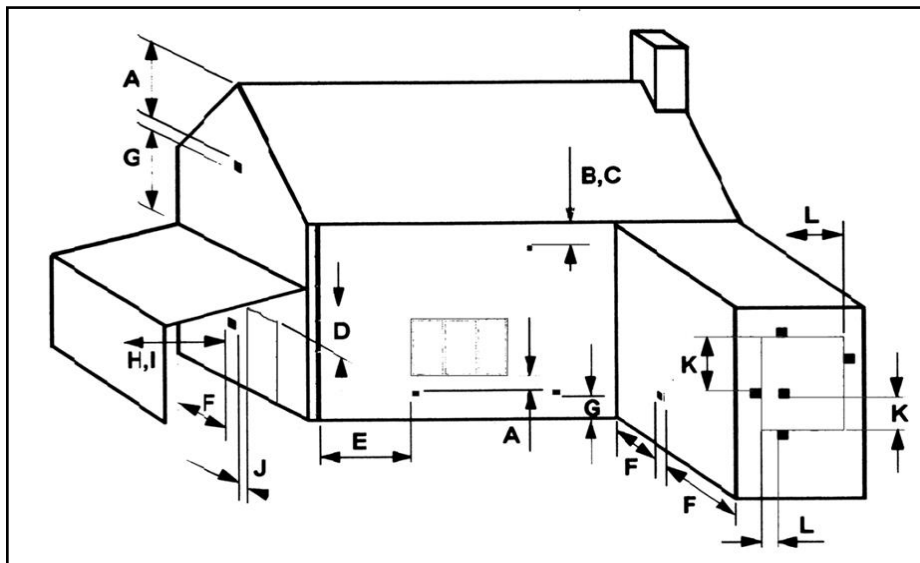

A. Directly below an openable window or other opening. E.g. air brick.....	300mm
B. Below gutters, soil pipes or drain pipes.....	300mm
C. Below eaves.....	300mm
D. Below balconies or carport roofs.....	600mm
E. From vertical drain pipes and soil pipes.....	75mm
F. From internal and external corners.....	300mm
G. Above ground, roof or balcony level.....	370mm
H. From a surface facing the terminal.....	600mm
I. From a terminal facing the terminal.....	1200mm
J. From an opening in a car port into a dwelling e.g. door, window, etc.....	1200mm
K. Vertically from a terminal on the same wall.....	1500mm
L. Horizontally from a terminal on the same wall.....	300mm

Ensure that gas supply is suitably sited

**To minimise the risk of cracking due to heat expansion the use of a 3 – piece back panel is recommended.**

Check with the supplier or manufacturer that the surround meets 150°C minimum rating (attention should especially be given to man-made materials such as resin). When installing in a timber framed dwelling reference must be made to the specific installation requirements stated in

**Clearance to Shelf**

Minimum clearance from hearth or base of opening to underside of combustible shelf should be 945mm provided the shelf depth is 75mm (3”). This gives a minimum clearance above the appliance of 200mm. For a shelf of 150mm (6”) the minimum height above the hearth or base of opening must be 1045mm. This will give a minimum clearance above the appliance of 300mm.

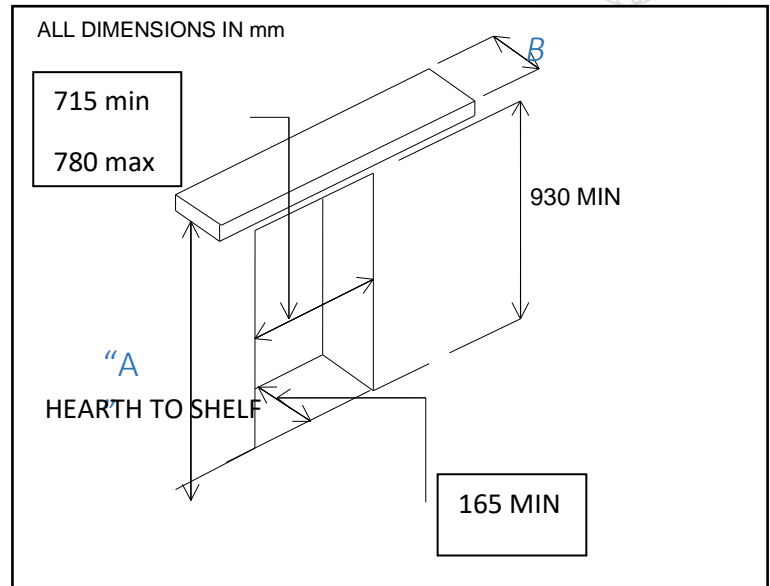

**Clearance to Sides of Fire**

Minimum width between vertical sides of combustible surround should not be less than 875 mm provided fire is central to the surround and sides do not project more than 150 mm. When vertical side forward projection is increased by 12.5 mm add 50 mm to inside width of surround.

**SECTION EIGHT Preparing the Appliance for Installation (installation instructions)**

- Carefully unpack the appliance from the carton and check the contents.
- Lift away the Box of ceramics, glass panel and Fire frame components.
- Remove the refractory components from the inside of the packaging.
- Remove the 2 x Transit bolts from the top of the appliance.
- The appliance is now ready for installation.



**INSTALLING THE APPLIANCE INTO CAVITY WALL** Ensure it is a suitable outside wall constructed of non-combustible materials and that the flue position meets the requirements previously described in Section 8.

- Before cutting out any opening, check at what height the opening needs to be, with regards to any surrounds that the fire is going to be fitted into, as the heights of Hearths and Bottom Slips can vary.
- Mark a vertical line on the wall at the intended centre of the appliance up from the horizontal base of the opening to the top horizontal of the opening 930mm.
- If inseting into the wall, mark the position for a `lintel` above the top horizontal line.
- Mark up Flue centre measurement of 767mm.
- Using a long masonry drill, make one pilot holes completely through the wall. Ensure the holes are drilled accurately at the centres and square to the wall both horizontally and vertically at the cross points previously marked.
- If inseting into the wall proceed as follows: Cut out the brickwork of the inner skin of the cavity wall for the lintel, and fix the lintel.
- Cut out the brickwork under the lintel, between the two outside vertical lines into the cavity. Ensure the cut out width is square and try the appliance into the opening.

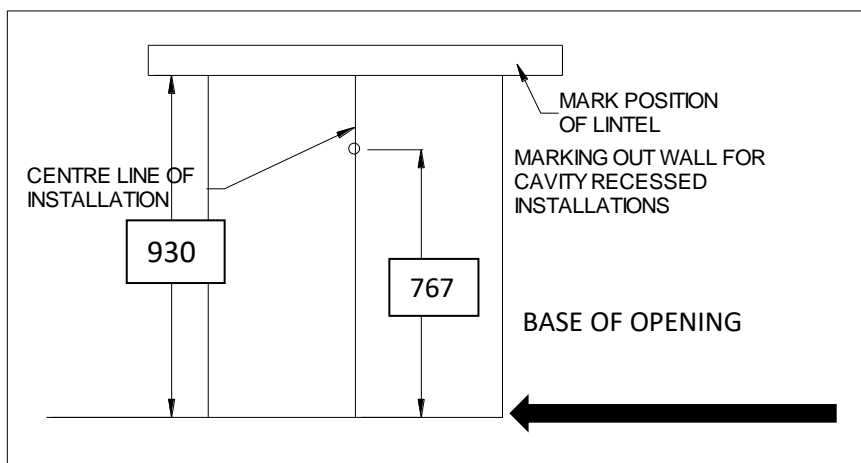

Using 150mm core drill cut a hole following the pilot hole. Drill from the outside through to the cavity to give a good finish on the outside.

- Remove any cavity insulation from the cut-out opening and for a further 100mm into the cavity gap each side and above.
- Pack “Rockwool” around the sides and top of the opening into the cavity for a depth of 100mm. Also put some behind the firebox if space is available.
- Offer the appliance into the opening and mark through the gas pipe entry hole (see connecting the gas supply section).
- Pass a tape measure through the core-drilled hole and record the distance from the back of the fire to the outside wall.
- Cut the outer tube to the recorded length. Add 25 mm to this measurement to determine the length of the inner tube and cut to size. **NOTE: The inner tube will be 25mm longer than the outer tube.**
- Remove the appliance from the opening and position the gas supply (see connecting the gas supply later in this manual), taking account of the relative gas regulations regarding a gas pipe in a cavity (sleeving and sealing etc). Note the gas feed must be fitted with an isolation valve.
- Position and seal the pipe to their respective spigots on the rear of the appliance (use flue seal or fire cement to ensure airtight seal, it must not obstruct the flue).
- Complete the gas connection (see connecting the gas supply later in this manual).
- Drill the four fixing holes through the hole in the flange of the appliance and fix back using plug and screws.
- If the flue outlet is fitted below 2m from the floor or a balcony, then a flue terminal guard must be fitted.

## SECTION NINE CONNECTING THE GAS SUPPLY (installation instructions)

**TURN OFF ANY GAS APPLIANCES THAT ARE SUPPLIED BY THE METER AND ISOLATE THE GAS SUPPLY BY TURNING OFF AT THE METER.**

- **The Gas & Power supply must be assessed at this stage.**
- For ease of installing the Gas Supply, the front outer frame can be removed by undoing the 4 x screws on the sides and lifting the frame outwards.
- The Gas Connection can be made by first removing the Burner by undoing the 3 x screws holding it in position and lifting away from the Left.
- The gas inlet cover is located on the righthand side of the Fire Box sump assembly. Remove the 4 off fixing screw and remove the plate plus gasket. **Please note special attention should be taken not to damage the gasket.**
- You will then have access to the isolating cock which is fitted in the supply feed.



The appliance is supplied with a factory fitted isolation

device to allow for an 8mm copper connection. No further isolation point is required.

- **THE GAS INLET ISOLATION DEVICE MUST BE ANGLED TO ALLOW ACCESS TO THE GRUB SCREW AND GAS TEST NIPPLE.**
- When a concealed gas fitting from the rear is required it is necessary to route the pipe to the Right side of the unit, taking into account the requirements of BS 6891 1988 dealing with enclosed pipes.

When installing the firebox into a cavity wall, any part of the installation pipe work installed in the void open to the cavity wall must be enclosed in a gas tight sleeve. It must be sealed at the point at which the sleeved installation pipe enters the fire (The Gas Safety (Installation and Use) Regulations Certificate of exemption number 1 of 1996). Where the pipe enters the fire the outer sleeve must be sealed to the grommet and the pipe must be sealed to its outer sleeve using suitable mastic.

### **POWER LEAD ROUTING**

- The power supply for this appliance is provided via AC power adaptor 230 VAC. The main cable terminates at the rear middle of the fire box. The length of the cable provided with the appliance is 1.65 metres. Care must be taken when siting the fire box not to trap the exposed main cable within the builders opening.
- The cable can be routed by passing the cable through the side of the chimney breast. It is good practice to run the cable within a sleeve of at least 15mm internal diameter, sealing the sleeve using a suitable sealant at the point the sleeve / cable terminates the chimney masonry.
- With power points that exceed the 1.65 metre distance, an optional 2.0 metre extension cable is available Part No 7147.
- There is a battery manual override option for backup supply in case of a power failure / power cut to the property. The battery holder and adaptor lead are available as an optional extra for the appliance. (Please note that the "C" cell batteries are not included). It is good practice to mention the battery option to the customer during the commissioning process.

- The cable system consists of retro fitting plug sockets which offers the following options.  
(Please see below).

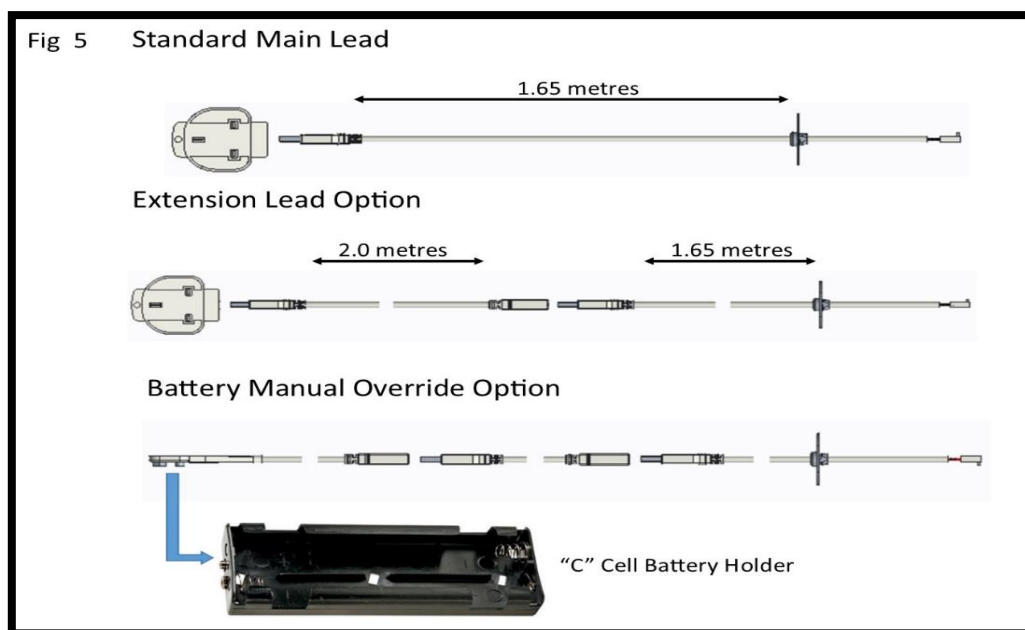

## SECTION NINE Commissioning the appliance (installation instructions)

### CHECK BURNER PRESSURE AND GENERAL OPERATION

- Turn on the supply to the appliance and check for soundness in accordance with the current codes of practice.
- Turn off the gas supply at the external isolation valve.
- The Gas Isolation point grub screws must be at an angle which will allow the test point to be accessed from inside the fire, when the Gas Cover is removed.
- Remove the pressure test point screw from the inlet elbow
- Connect the pressure gauge by feeding the tube through the front grill so the gas cover and burner can be temporary fitted to do pressure test.
- Turn on the gas to the appliance at the isolation valve.
- Light the appliance as described in the user instruction section. Page 6 turn on (start-up).
- Check the inlet pressure is 20 mbar +/- 1.0 mbar with other appliances running.
- Turn off gas supply, at the isolation valve. Disconnect the pressure gauge and replace the pressure test point screw.
- Turn on the appliance and check the pressure test point for soundness with detection fluid.
- Refit the Gas Cover Plate.

## SECTION TEN Assemble the appliance (installation instructions)

- Refit the Outer Frame making sure the screws are securely tightened.
- Fit the Front Infill from the front.
- Fuel bed layout should be done using the guidance stipulated on pages 14 - 19 of the User Instruction section.
- Position the shapes components as described as it is important that the shapes are positioned exactly as described to ensure the correct operation of the appliance. Badly positioned shapes may result in the gas flame being driven forward onto the glass and permanently marking it.
- Taking great care, locate the glass panel within the gap between bottom retaining bracket and glass seal.
- When located push back against the seal and locate and tighten the three fixing brackets. (Please note over tightening the fixing nuts can result in damage to the glass panel) Glass is not covered by warranty.
- When assembly is complete please refer to pages 6 -10 for operation.

## SECTION ELEVEN Instruct and Advise the Customer (installation instructions)

- Demonstrate the lighting and extinguishing procedure to the consumer/user and the removal and refitting of the trim for cleaning.
- Explain that for the first few hours of the fire operating there will be an initial odour. This is due to the curing of the paint, the appliance should be operated on its high setting, and it is recommended that a window is left open until that odour has completely disappeared.
- Instruct on the glass removal and refitting.
- Instruct on the shapes cleaning and advise that a vacuum cleaner can be used but only after all the loose shapes have been removed. **Refer to 'Health & Safety Notice (See Section One) at the front of this booklet before proceeding.**
- Advise customer that with use the inside of the air box will change colour, particularly the sides and rear. This is quite normal and often adds to the overall effects of the appliance.
- Advise that the appliance should be serviced annually by a competent person i.e. a **Gas safe registered engineer** in accordance with these instructions.
- Although the appliance is fitted with a glass front which acts as a dress guard it is strongly recommended that a fireguard should be used for the protection of children, the elderly or infirm. Fireguards should conform to B. S. 6539 (1984) (Fireguards for use with solid fuel appliance).
- **Hand these instructions to the user.**
- 

## SECTION TWELVE Maintenance Instructions (maintenance instructions)

### General

- Servicing should be carried out annually by a competent person such as a GAS SAFE-registered person in accordance with the relevant regulations, to ensure the safe and correct operation of the appliance.

**Warning: - Before commencing any service or replacement of parts, turn off the gas supply to the fire.**

- After servicing check for gas soundness.
- When ordering spare parts please quote appliance name and serial number these can be found on the data badge, which is located on the left hand side of the base of the appliance.
- If soot has accumulated check to establish cause, rectify and clean flue accordingly.

**Important: - Refer to 'Health & Safety Notice (See Page 3) at the front of this booklet before removing the fuel bed components.**

- Examine the shapes for signs of cracking and replace if necessary. (IMPORTANT) see shape layout procedure in section four of this manual before attempting to replace items, which should only be replaced as a complete set with no extra shapes added.



## Maintenance Instructions

**Before commencing any service or replacement of parts, turn off the gas supply to the fire.**

### **Removal of Gas Control.**

1. Switch off the mains supply from the main supply plug socket.
2. Remove the Inner Frame by lifting up and outwards.
3. Remove the 3 x Glass retaining brackets positioned on both sides and top of the glass panel.
4. Remove the glass panel.
5. Remove the Front Infill.
6. Remove the Burner by undoing the 3 x screws and lift away from the Right-Hand side.
7. Remove 16 x screws on Service Cover Plate and remove.
8. Isolate Gas at Restrictor Elbow and disconnect pipe.
9. Disconnect Injector Pipe from Valve.
10. Disconnect Pilot Pipe from Valve.
11. Disconnect Thermocouple Nut from rear of Valve and unplug Valve Power Lead from E.D.B.
12. Undo the two nuts holding Valve to carrier with a 7mm Nut Spinner, remove earth lead.
13. Lift valve out of way, change, service or replace valve then replace all pipes and leads in reverse order,
14. Turn on gas supply, check for soundness, correct operation, and re-commission.

### **Removal of E.D.B. unit.**

1. Follow removal of Gas Control ( 1 – 7 )
2. Disconnect Pilot Pipe from Valve.
3. Unplug Power lead and Motor lead from E.D.B.
4. Undo the two screws holding Pilot assembly, remove pilot shield, and lift upwards slightly, avoid damaging Pilot Gasket (2110), this will allow room to lift the E.D.B. up.
5. Undo the two M3 nuts Holding E.D.B. to carrier, lift away to allow access to remove pugs and leads.
6. Replace E.D.B. and reconnect all plugs and leads.
7. Re-connect pilot assembly making sure the Pilot Shield is fitted correctly, (Picture ref on page 22).
8. Re-connect Pilot Pipe to Valve.
9. Turn on gas supply, check for soundness, correct operation and re-commission.

When replacing the E.D.B. or Handset the two items will need to be re-paired using the following procedure.

### **Replacement Handset.**

Follow the guide stipulated in users instructions “Changing the handset batteries” to load the batteries into the new handset.

### **Re-Pairing the handset or ECU unit.**

When replacement handset or ECU the two items will need to be re-paired using the following procedure.

1. Start the pairing process with the power to the appliance turned off.
2. Make sure that the remote handset has batteries installed then turn the power on to the appliance on.
3. Within 30 seconds of power on, press any button on the remote handset.
4. The LED on the handset will start to flash quickly indicating the pairing process has started. If successful pairing is achieved, then the LED will show 5 slow flashes. If pairing fails, there will be 3 long flashes.
5. If this happens, then remove power to the appliance and repeat the pairing process.

## Maintenance Instructions

### **Replacement of Injector.**

1. Repeat operations 1-7 for removal of gas control.
2. Undo 14mm Injector Lock nut.
3. Undo the 2 x screws holding the Injector Bracket to Tray Sump and remove.
4. Undo Injector Nut from Pipe, clean or replace.
5. Re-assemble in reverse order.
6. Turn on the gas supply, check for soundness and recommission.

### **Replacement of the Thermocouple.**

1. Repeat operations 1-7 for removal of gas control.
2. Disconnect Pilot Pipe from Valve.
3. Disconnect Thermocouple Nut from rear of Valve
4. Undo the two screws holding Pilot assembly, remove pilot shield, and lift upwards slightly, avoid damaging Pilot Gasket (2110), this will allow room to lift the E.D.B. up.
5. Undo the two M3 nuts Holding E.D.B. to carrier, lift away to allow access to remove the two Interrupter leads.
6. Unplug the two Thermocouple interrupter leads from E.D.B.
7. Lift the pilot assembly up slightly and undo the Thermocouple nut from the pilot assembly and remove Thermocouple and replace.
8. Replace in reverse order, making sure the Pilot Gasket is not damaged, if it is, a replacement one will need to be fitted (2110), refit Pilot assembly and Pilot shield
9. Turn on gas supply, check for soundness, correct operation, and recommission.





### **Replacement of the Pilot Injector.**

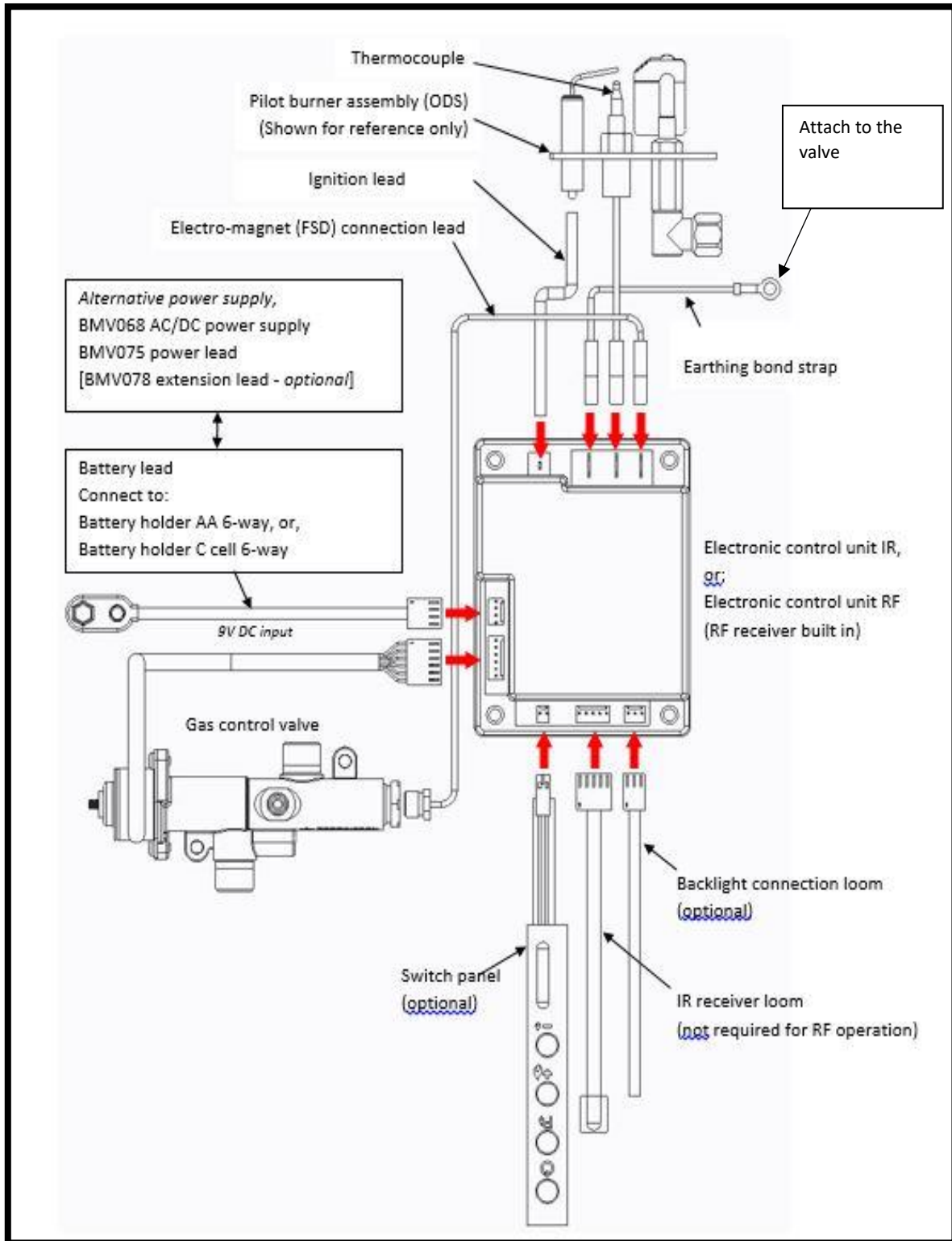

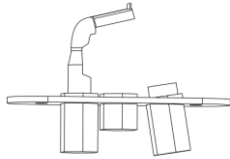
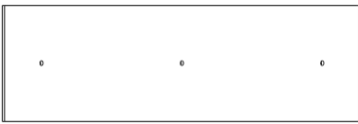

1. Repeat operations 1-7 for removal of gas control.
2. Disconnect Pilot Pipe from Valve.
3. Undo the two screws holding Pilot assembly, remove pilot shield, and lift upwards slightly, avoid damaging Pilot Gasket (2110).
4. Lift the pilot assembly up slightly and undo the Pilot injector nut from the pilot assembly.
5. Pull the pipe gently back taking care not to damage pipe or Olive
6. Replace in reverse order, making sure the Pilot Gasket is not damaged, if it is, a replacement one will need to be fitted (2110), refit Pilot assembly and Pilot shield in correct position, (Picture ref on page 22).
7. Turn on gas supply, check for soundness, correct operation, and recommission.

## SECTION THIRTEEN Wiring Diagram (maintenance instructions)

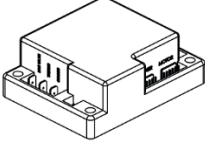
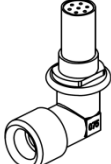

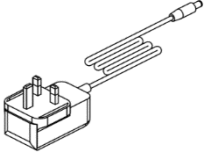
## Short Spare list

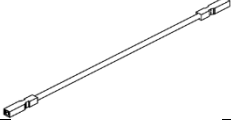
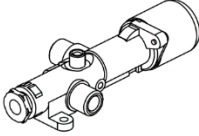
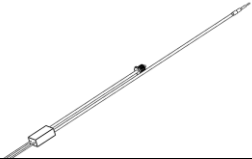
Image	Description	Part number
	Pilot Assembly	8674
	Relief flap gasket	8322
	Side liner	Glass: 8319 Ribbed: 8324
	Rear liner	Glass: 8318 Ribbed: 8323
	Front glass panel	8317
	Handset	8081
	EDB	8080
	Injector stamped 770	7815

	9V transformer	7145
	Earth lead	6776
	Ignition lead	6646
	Valve	6590
	Thermocouple	4739
	Pilot gasket	2110

**Register your appliance online today to active your warranty**



## BALANCED FLUE GAS FIRE COMMISSIONING CHECKLIST

**This Commissioning Checklist is to be completed in full by the competent person who commissioned the gas fire as a means of demonstrating compliance with the appropriate Building Regulations and then handed to the customer to keep for future reference.**

Failure to install and commission according to the manufacturer's instructions and complete this Benchmark Commissioning Checklist will invalidate the warranty. This does not affect the customer's statutory rights. **PLEASE COMPLETE IN BLOCK CAPITALS.**

Customer name:										Telephone number:									
Address:																			
Gas Fire make and model:																			
Installation location: i.e living/dining room.																			
Gas Fire serial number:																			
Commissioned by (PRINT NAME):										Gas Safe register number:									
Company name:										Telephone number:									
Company address:																			
										Commissioning date:									
Building Regulations Notification Number (if applicable):																			

Site Requirements	Yes	N/A
Is the flue terminal sited and fitted as per the manufacturer's instructions?		
Has a flue guard been fitted?		
<b>Hearth Requirements- where fitted</b>		
Is the hearth constructed from non -combustible material?		
Is the hearth a minimum of 12mm thick with a minimum floor to top surface of 50mm?(BS5871) or as per manufacturer's instructions?		
Is the hearth for open fronted fires a minimum of 760mm wide and has 300mm projecting from the fire opening (BS6871) or to manufacturer's instructions?		
Mounting height (where applicable) has the fire been installed to the correct mounting height- as per manufacturer's instructions?		
<b>Firebox and Fuel Bed</b>		
Has the fuel bed, coals, logs, pebbles etc. been fitted to manufacturer's instructions?		
<b>Gas Supply</b>		
Has an isolation valve inlet elbow been fitted for servicing?		
Has the gas supply been thoroughly purged prior to connection to remove any debris?		
Has a gas tightness test been completed prior to breaking into the gas supply and following completion of installation?(IGEM/UP/1B)		
Has the correct gas type been chosen as per manufacturer's instructions?		
Record burner gas pressure reading? If only the supply pressure is available a gas rate must be undertaken.(GSIUR REG26/9C)		
Record dynamic inlet gas pressure (working pressure) reading (all gas appliances running)		
<b>Installation</b>		
Has the gas fire/convector heater been installed and commissioned in accordance with manufacturer's instructions?		
Has the gas fire/convector heater been installed with the correct clearance to combustible materials, service and general clearances adhered to as per manufacturer's instructions?		
The operation of the fire/convector heater and controls have been demonstrated and understood by the customer, including replacement of batteries?		
The manufacturer's literature, including Benchmark Checklist and Service record has been explained and left with the customer?		
Has the appliance been registered with the Local Authority, as detailed on the Gas Safe web site and is a legal requirement and forms part of the warranty?		
Commissioning Engineer's Signature		
Customer's Signature (To confirm satisfactory demonstration and receipt of manufacturer's literature)		

\*All installations in England and Wales must be notified to be Local Authority Building Control (LABC) either directly or through a Competent Persons Scheme. A Building Regulations Compliance Certificate will then be issued to the customer

# SERVICE RECORD

It is essential that your gas fire is serviced regularly and that the appropriate Service Interval Record is completed. Service Provider

Before completing the appropriate Service Record below, please ensure you have carried out the service as described in the manufacturer's instructions. Always use the manufacturer's specified spare part when replacing controls.

<b>SERVICE 01</b>	Date:
Engineer name:	
Company name:	
Telephone No:	
Gas safe register No:	
Comments:	
Signature	

<b>SERVICE 02</b>	Date:
Engineer name:	
Company name:	
Telephone No:	
Gas safe register No:	
Comments:	
Signature	

<b>SERVICE 03</b>	Date:
Engineer name:	
Company name:	
Telephone No:	
Gas safe register No:	
Comments:	
Signature	

<b>SERVICE 04</b>	Date:
Engineer name:	
Company name:	
Telephone No:	
Gas safe register No:	
Comments:	
Signature	

<b>SERVICE 05</b>	Date:
Engineer name:	
Company name:	
Telephone No:	
Gas safe register No:	
Comments:	
Signature	

<b>Product</b>	<b>A-0830</b>	<b>Serial No Prefix</b>	<b>TP</b>
<b>ID Label</b>	<b>A-0839</b>		

Data Badge	
Burner Tray / Box Assembly	
Air Test Completed	
Warning Label (1409)	
Grommet (1406)	
Glass Panel (8317)	
P5 BF Log Set Mrk 2 (8325)	
Fascia Assembly (8314)	
Fire Place Frame (8301)	
9v Transformer	
Mains Lead Fitted	
“AAA” Batteries ( 2 )	
Remote Control Handset (8081)	
Front Infill (8303)	
7mm Spinner (5435)	
Owners Book	
Snorkel Flue Assembly	
Embaglow (6844)	
Transit bolts Label	
Inspector	
Serial Number	