



INFINITY



Instruction for user, Installation & Servicing 800 HD

**With Under Bed
Lighting**

Keep this booklet for service log and future reference

IMPORTANT



This appliance is guaranteed for 12 months subject to conditions. The 5 year extended parts warranty will only be valid if the annual service recommended in this manual has been completed and appliance has been registered online.

Contents

| | |
|---|----|
| EXTENDED FIVE YEAR PARTS WARRANTY | 1 |
| Benchmark Scheme | 1 |
| Introduction | 2 |
| Consumer Protection Information | 2 |
| Lighting the Appliance & General Operation Of Control | 4 |
| Auto (Thermostatic) Control | 6 |
| Menu features | 7 |
| Changing The Handset Batteries. | 9 |
| Cleaning the 800 HD with UBL Appliance | 10 |
| Fuel Bed Layout | 11 |
| Laying the Walnut Fuel Bed and Embaglow | 11 |
| Silver Birch Fuel Bed | 17 |
| Sifting the Appliance | 23 |
| Commissioning the Appliance | 35 |
| Annual Service Requirement. | 39 |
| Fault Finding Charts | 41 |
| Wiring Diagram | 44 |
| Maintenance | 45 |
| Short Spares List | 49 |
| GAS FIRE COMMISSIONING CHECKLIST | 53 |
| SERVICE RECORD | 54 |



EXTENDED FIVE YEAR PARTS WARRANTY

In order to validate your extended 5 years parts warranty please read the Benchmark Scheme on the opposite page and ensure your installer has filled in the appropriate checklist.

This in no way reduces your statutory rights

Your warranty commences from the date of purchase and you must retain your receipt or invoice as proof of a purchase date.

THIS EXTENDED WARRANTY SPECIFICALLY EXCLUDES GLASS AND SOFT REFRACTORY COMPONENTS, THE BULB AND ANY BATTERIES.

Terms and Conditions

1. The appliance must be installed by a GAS SAFE registered person.
2. The appliance must be used in accordance with the user's instructions.
3. The appliance must be serviced annually by a GAS SAFE registered person.
4. The benchmark and service log must be correctly filled out and the record of annual services must be up to date and supported by receipts in each case.
5. This warranty is not transferable and relates to the original installation only.
6. The appliance has not been subjected to misuse or accident or been modified or repaired by any person other than the authorized employee or authorized representative of Charlton and Jenrick Ltd.
7. The registration form must be returned within 1 month of purchase.

Technical Help Desk 01952 200 444

For gas emergency call Transco: 0800 111 999

Benchmark Scheme



Charlton and Jenrick Ltd is a licensed member of the Benchmark Scheme which aims to improve the standards of installation and commissioning of domestic heating and hot water systems in the UK and to encourage regular servicing to optimise safety, efficiency and performance. Benchmark is managed and promoted by the Heating and Hotwater Industry Council. For more information and the full code of practice please visit www.centralheating.co.uk

Please ensure that the installer has fully completed the Benchmark Checklist on the inside back pages of the installation instructions supplied with the product and that you have signed it to say that you have received a full and clear explanation of its operation. The installer is legally required to complete a commissioning checklist as a means of complying with the appropriate Building Regulations (England and Wales).

All installations must be notified to Local Area Building Control either directly or through a Competent Persons Scheme. A Building Regulations Compliance Certificate will then be issued to the customer who should, on receipt, write the Notification Number on the Benchmark Checklist.

This product should be serviced regularly to optimize its safety, efficiency and performance. The service engineer should complete the relevant Service Record on the Benchmark Checklist after each service.

The Benchmark Checklist will be required in the event of any warranty.

It is a requirement that the gas fire is installed and commissioned to the manufacturer's instructions and the data fields on the commissioning checklist completed in full.

To instigate the guarantee, the gas fire needs to be registered with the manufacturer within one month of the installation.

To maintain the guarantee, it is essential that the gas fire is serviced annually by a Gas Safe registered engineer. The service details should be recorded on the Benchmark Service Interval Record and left with the householder.

Introduction

The 800 HD with Under Bed Light has been designed and tested to the requirements of EN 613 and is suitable for use in Great Britain.

800 HD with UBL incorporates a single gas valve which selects ignition pilot, with variable setting between low and high setting and is operated via remote control hand device or optional smart app device. This system is powered by mains electricity via pre-wired transformer plus supply cord. Alternative power supply is available for users during mains interruptions.

The 800 HD incorporates a safety device in form of an Oxygen Depletion System, which constantly monitors the oxygen in the room and will cause the fire to switch off if the oxygen level reduces, for instance due to insufficient ventilation or a blocked flue.

Consumer Protection Information

As manufacturers and suppliers of heating products, we take every care to ensure that the design and construction has to meet the general safety requirements when properly used and installed. To this end, our products are thoroughly tested and examined before dispatch.

Any alteration that is not approved by the manufacturer could invalidate the approval of the appliances, operation of the warranty and could affect your statutory rights.

This appliance could contain some materials that could be interpreted as being injurious to health. It is the users / installers responsibility to wear protective clothing when handling the following materials. Artificial fuel, mineral wool, insulation material, refractory/ceramic fibers and glass yarn. May be harmful if inhaled, may be irritating to skin, eye, nose and throat.

When disposing refractory / ceramic materials to keep dust to a minimum these materials should be securely wrapped in polythene and clearly labelled "RCF waste". These materials are not classified as hazardous waste and should be disposed of at a site licensed for disposal of industrial waste.

Important Information

The appliance is for use on Natural Gas (G20 @ 20mbar) or LPG (G31 @ 37mbar).

The Chimney or flue (unless new or previously used with a gas appliance) shall be swept before installation if been used for solid fuel.

In Great Britain, the appliance must be installed by a competent person whose name appears on the gas safe register. All Gas Safe engineers should possess an ID carrying the logo below.



The glass front of this appliance acts as a dress guard, conforming to BS 1945 (1997) however a fireguard to BS6539 (1997) must be used to protect young children, the elderly or infirm.

The Appliance must not be used with the glass safety screen removed or if it is damaged or cracked.

During initial "burn off", an odour may be evident during the first few hours of use. This is due to the surface coating on the metal work "burning off". The odour produced is harmless and will disappear after a short period of time.

During the normal operation of the fire some black staining may appear on some parts of the fuel bed. This is quite normal. However, if excessive black staining occurs it may be due to the fuel bed shapes laid incorrectly. This should be checked prior to contacting a service engineer.

Care must be taken to prevent any damage being caused to surrounding soft furnishing or decoration. Many embossed vinyl coverings may become discoloured if placed too close to the appliance. It is suggested that a sample of the proposed wall covering should be placed above the appliance at its hottest point first. The appliance should then be run on high rate over a couple of days

It is advised that this appliance is serviced annually as recommended by Gas Safe. This is more likely to provide trouble-free operation and is a requirement of the extended warranty.

In GB (Great Britain) the fire does not normally require purpose built ventilation, but if for any special reason purpose built ventilation is provided it should be checked periodically to ensure freedom from obstructions.

Lighting the Appliance & General Operation Of Control

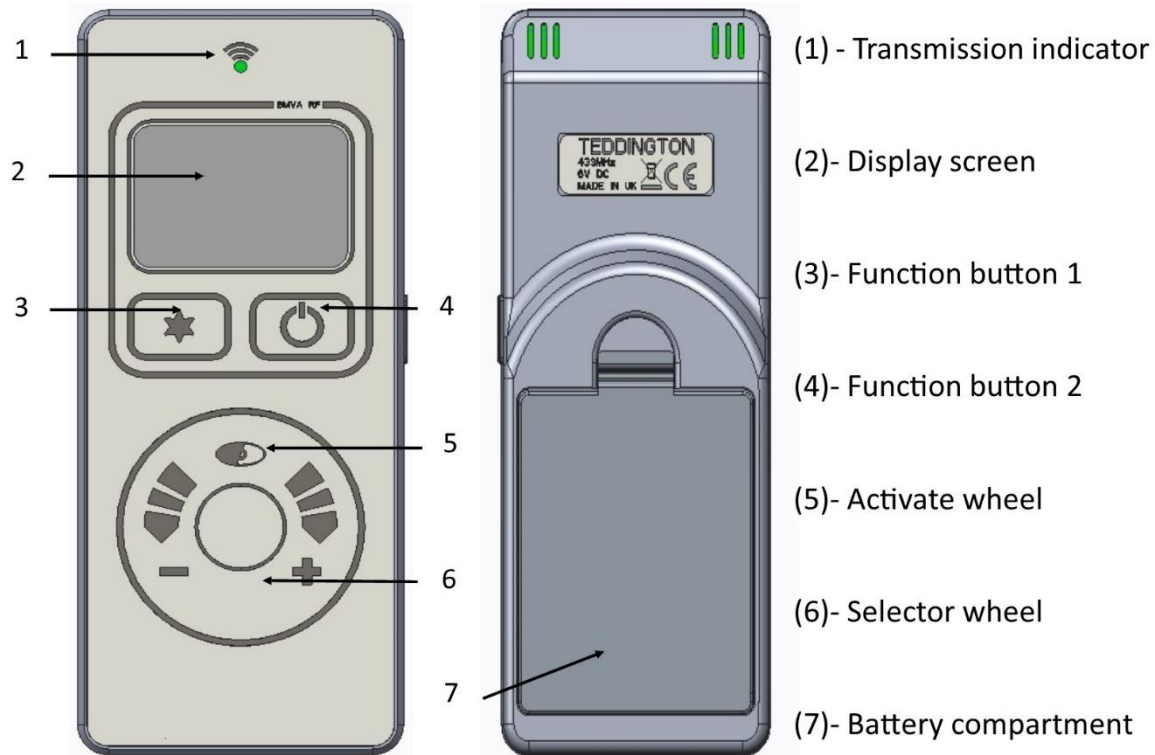

Handset up video

Display overview

Press  to awaken the handset from its dormant sleep mode at any time. Fig 1 shows the display neutral, ready to turn on.

Turn on (start up).

Pressing and holding  displays an "UNLOCK" graphic Fig 2 prompting the  button to be pressed simultaneously. Whilst both  &  are pressed a progress bar Fig 3 will complete. If either button is released before the progress bar has completed the operation will cancel. Once the progress bar has completed the handset will display the status of the fire (priming – ignition – pilot – main burner) finishing at the fire "on" display screen Fig 4.

Note: if repeated delayed ignition is experienced during start-up it is recommended that the appliance is checked by a gas safe engineer

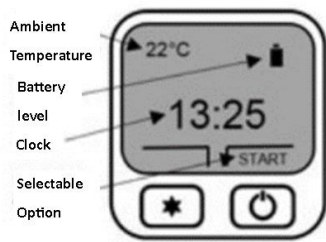

Fig 1 Neutral Display



Fig 2 Unlock graphic



Fig 3 Progress bar



Flame height adjustment

Once the fire has been started (after a period of 10 minutes) the flame height can be decreased by moving your finger clock wise or decreased moving your finger anti-clock wise using the selector wheel. Once the desired flame level is set, remove your finger from the selector wheel to transmit your selection to the receiver. Six flame levels are selectable. Press  whilst the display is active to display the current flame level.

Turn off (shut down)

To turn the appliance off, press and hold down  until the progress bar has completed. If the  is released before the progress bar has completed the operation will cancel.

Mode select

With the fire running on manual operation you can access three further "modes". Press  for "mode". Use the selection wheel to cycle through the three options, "Auto", "Sleep" and "Light". Press  to select "Auto" or "Sleep"

Sleep:- Use the selector wheel to choose from the available time range of 5 minutes to 1 hour 30 minutes. Once the desired countdown time has expired the appliance will turn off. By pressing the  button during the countdown will cancel the countdown timer if required.

Light:- Use the selector wheel and scroll to the "light" option. An appliance back light can be turned on or off by pressing the  button.

Note: The handset contains a sensitive temperature measurement device. To achieve the best thermostatic efficiency do not place the handset near the heat source, avoid covering, direct sunlight or near a draft or open window etc. Place the handset at a midpoint in the room or area being heated. Allow 5-10 minutes for the handset to stabilize if subjected to extremes of temperature.

Auto (Thermostatic) Control

Press  to awaken the handset from its dormant sleep mode at any time.

Selecting auto control

The "auto" function can only be selected once the appliances has been started and initiated into "manual" mode. Once in manual mode, press and release the  button to enter the "mode" options. Auto is the first option, press to enter auto mode.

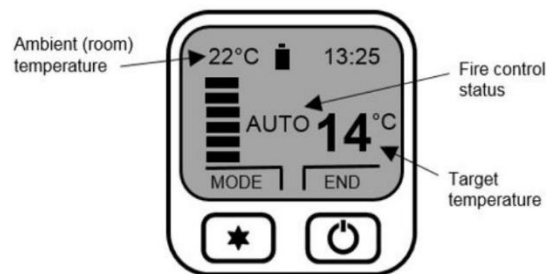

Fig 5 Auto Thermostatic mode



Adjusting target temperature

Use the selection wheel to increase or decrease the temperature to the desired level, release your finger from the wheel to transmit the target temperature (See Fig 5) to the receiver. The "auto" function will now modulate the flame height to achieve your target temperature. The selectable temperature range is 1 degree C to 29 degree C.

Cancelling auto function

Press  to "end" and cancel the "auto" control. The handset will return to manual control.

Menu features

The menu can be accessed by pressing and holding the  button (approx. 5 seconds) until the menu graphic completes (see fig 6). Use the selector wheel to highlight one of the available options. Press  to enter the required option.

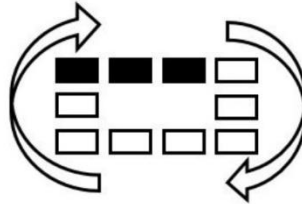





Fig 6 Menu Graphic



Set clock

The handset clock has a dedicated 24 hour display. Use the selector wheel to firstly set the hours. Press  to change to minutes select. Use the selector wheel to change the minutes. Press the  button to alternate hours and minutes to make any other alterations. Finally, press the  button to save the clock setting.

Display

Temperature display units-use selector wheel to select either Celsius (degree C) or Fahrenheit (degree F). Press the  button to save selection.

Gas fire (pair code)

The device screen displays the current operating channel of the handset. To delete the channel press  &  simultaneously or  to return to the menu option.

Reset

To restore the handset back to its original factory setting select "reset" from the menu options. Press - & - simultaneously to complete the reset command – to return to the menu options.

Under Bed Light Feature

The Under Bed Light feature offers multiple lighting features to enhance a flame effect or provide lighting effects whilst the appliance heat output is not required.

The Under Bed Light feature can be operated whilst the fire is on or off.

Press  to awaken the handset from its dormant sleep mode at any time.

The Under Bed Light effects can be accessed in three operating modes:

Access

1] Standby (fire off)



2] Manual (fire on)



Scroll clockwise on selector wheel until the following screen is visible:

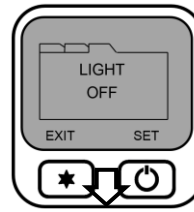

3] Auto (fire on)

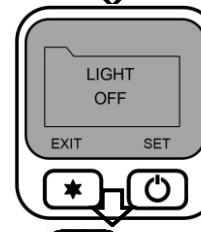
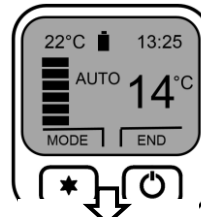

Adjustment

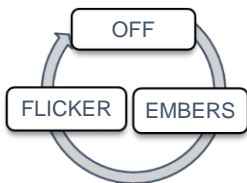

Scroll on selector wheel until the desired effect is highlighted. Release finger from wheel to send selection.

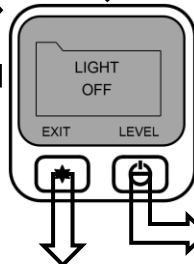

Scroll on selector wheel to choose brightness level. Release finger from wheel to send selection.



Returns to main operating screen.

Notes:

- If no command is entered within 15 seconds whilst in the 'LIGHT' function the handset will return to the main operating screen.
- Brightness alternative on/off switch. 0% = lights off, any value greater than 0% will turn lights on for the effect selected. From 'light off' screen increasing brightness will turn backlighting on using last used effect.
- Brightness range feature is only effective in embers lighting effect.
- Turning the appliance off from a lit condition will turn Under Bed Light off also.

Changing The Handset Batteries.



Fig 7 Battery compartment

The handset operates from four AAA 1.5V batteries. New alkaline batteries are recommended. Do not mix new and old batteries. When inserting the batteries, observe and position batteries according to the battery compartment graphics (see Fig 7). When the batteries are inserted the handset will attempt to pair.

Cleaning the 800 HD with UBL Appliance

Ensure the appliance is cold before proceeding.

The outer metal work frame should be cleaned using a damp cloth.

To clean the glass panel, remove the four M4 nuts fixing the glass clamp to the glass panel. (See Fig 8). With the nuts removed, pull the glass clamp clear of the four studs. Finally lift the glass panel out of the bottom glass fixing.

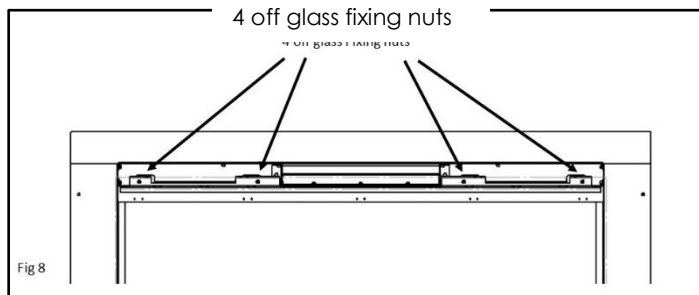

Using a damp cloth and warm soapy water will remove a majority of stains. For more substantial marking we recommend the use of ceramic hob cleaner. These are available from all leading super markets. The brands of hob cleaner we have tested and found suitable are "Hob brite" & "Vitro clean". Ensure the glass is dry and re-assemble. Take care not to over-tighten the glass as this will result in the glass breaking. The glass is not covered by warranty.

Note- Never operate the appliance when the glass panel is removed or broken. The glass may discolour quickly when first installed, and it should be cleaned. This is due to the burning of the refractory fuel bed shapes.

To Clean the Pilot assembly. Remove the four M4 nuts and glass clamp (See Fig 8). Carefully lift the glass panel from within the bottom location. Remove the log and bark chip shapes. Lift out the air tray assembly from within the burner shelf.

The pilot is located on the right hand side of the appliance, remove any debris in or around the pilot head and the aeration hole. This can be achieved using the nozzle of a vacuum cleaner. It is advisable not to blow the debris within the pilot head or aeration hole as this may cause more of a restriction and not rectify the problem.

Note-Take care when cleaning in this area so as not to damage the pilot assembly.

Cleaning the fuel bed shapes. (Please refer to customer protection information on page 3 of this booklet before cleaning or replacing any refractory materials).

The fuel bed components are delicate and they should be handled with great care. They can be brushed very gently with a soft brush to remove dust or any deposits. A vacuum cleaner may only be used after the loose components and moulded shapes have been removed from the 800 HD with UBL fire box.

It is important that all fuel bed shapes are positioned as shown in these instructions.

Fuel Bed Layout

Laying the Walnut Fuel Bed and Embaglow

EMBAGLOW IS FOR NATURAL GAS VERSIONS ONLY



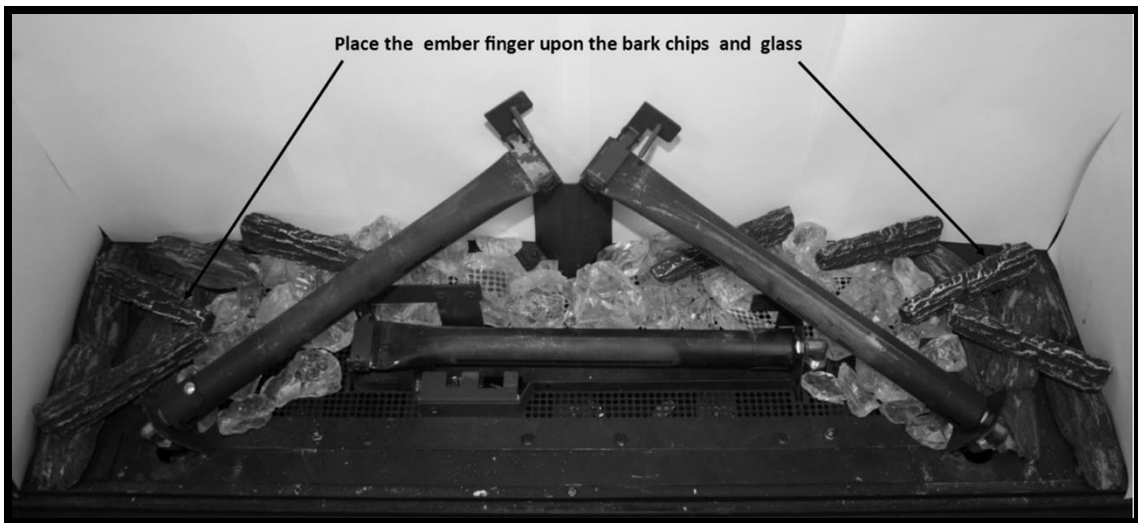
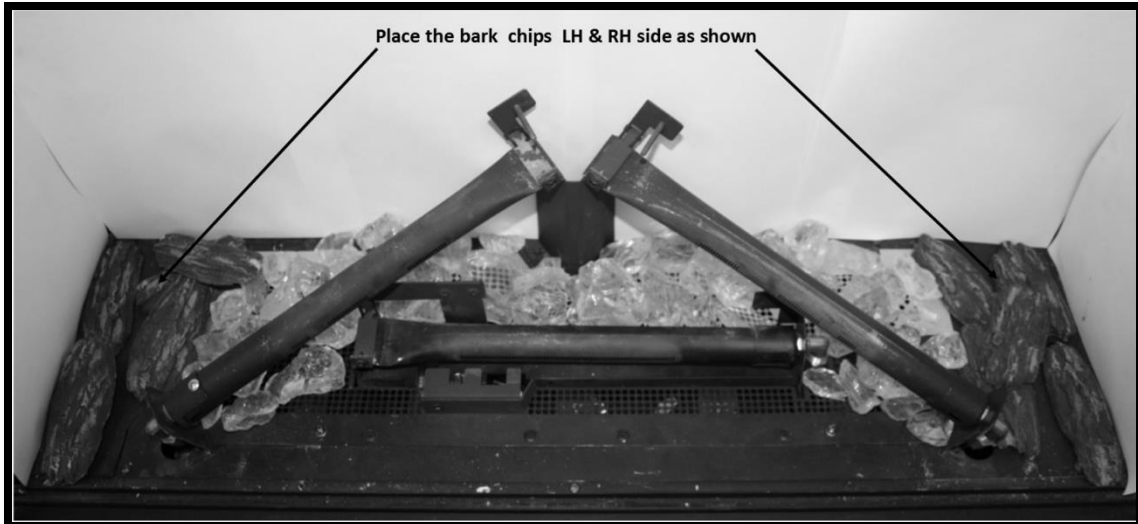
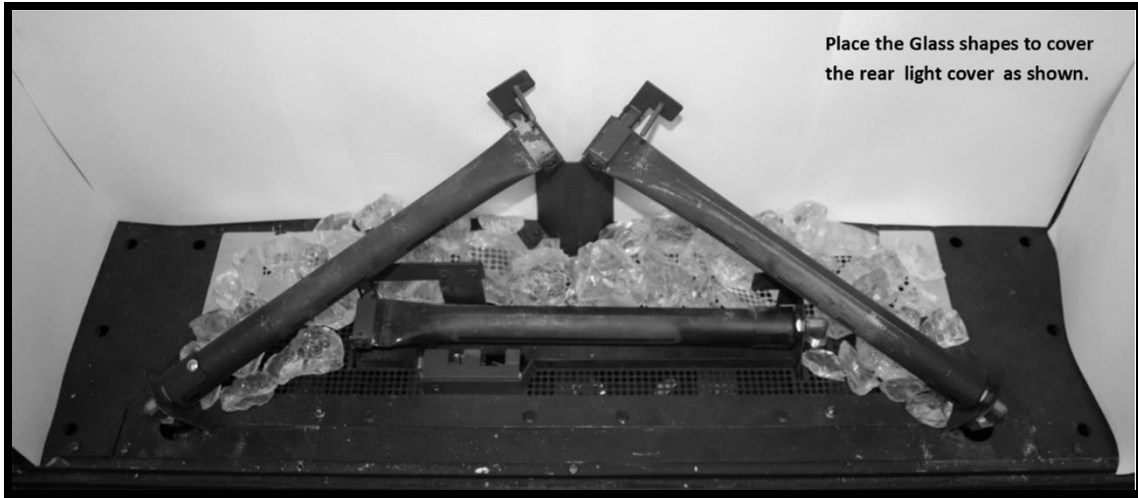



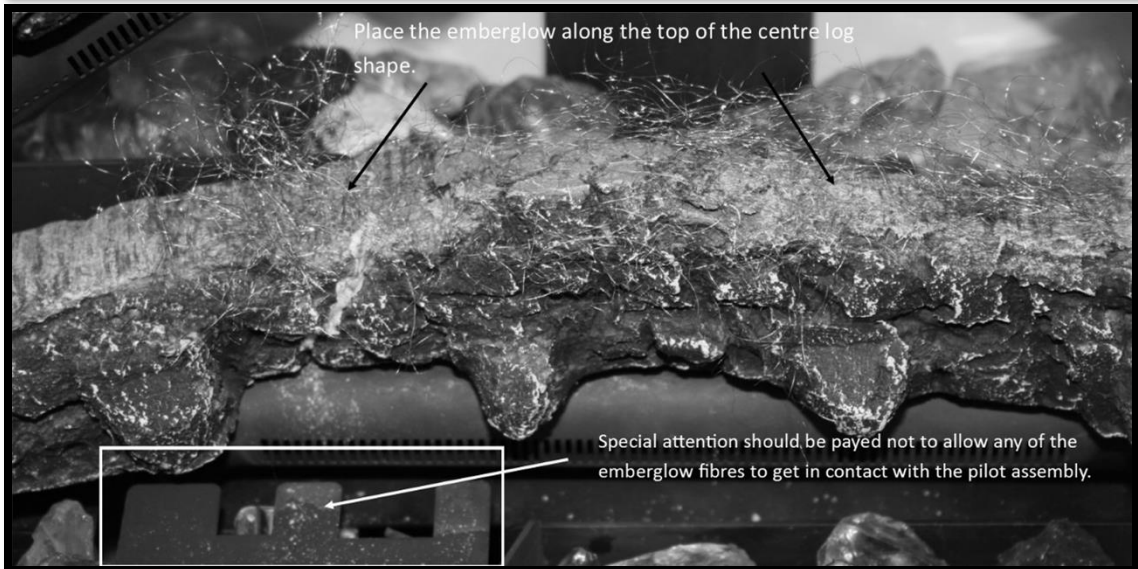

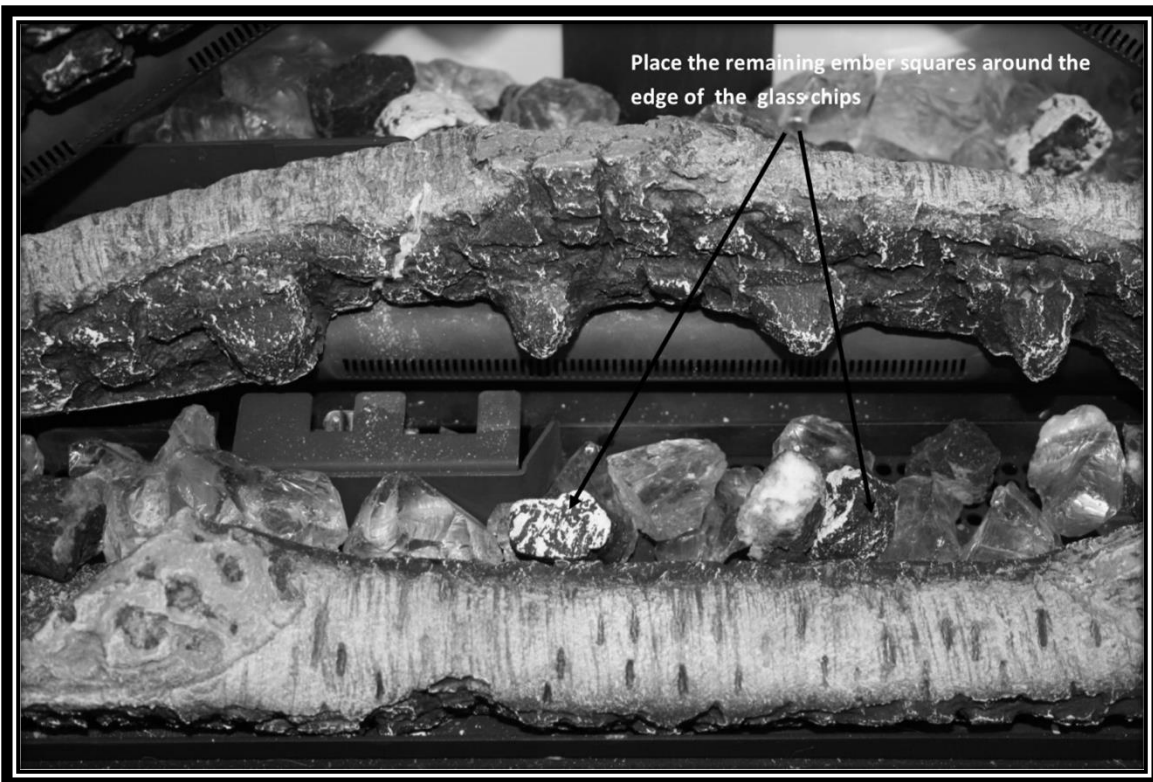
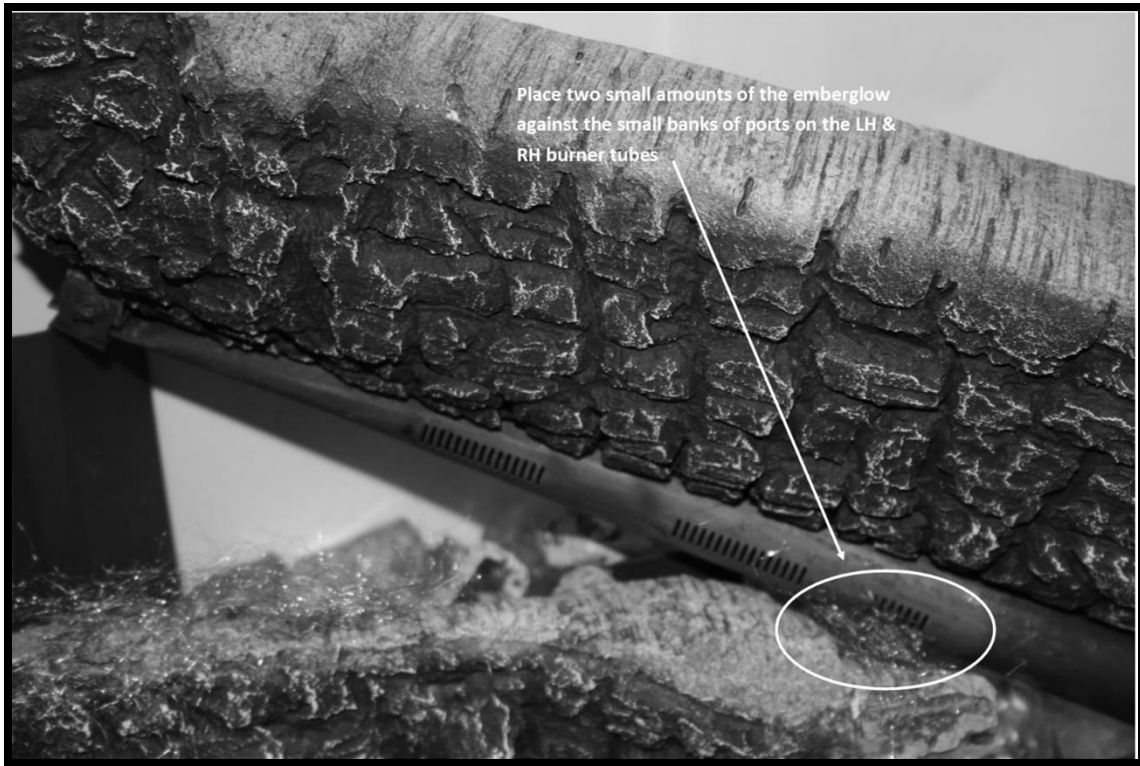



Silver Birch Fuel Bed

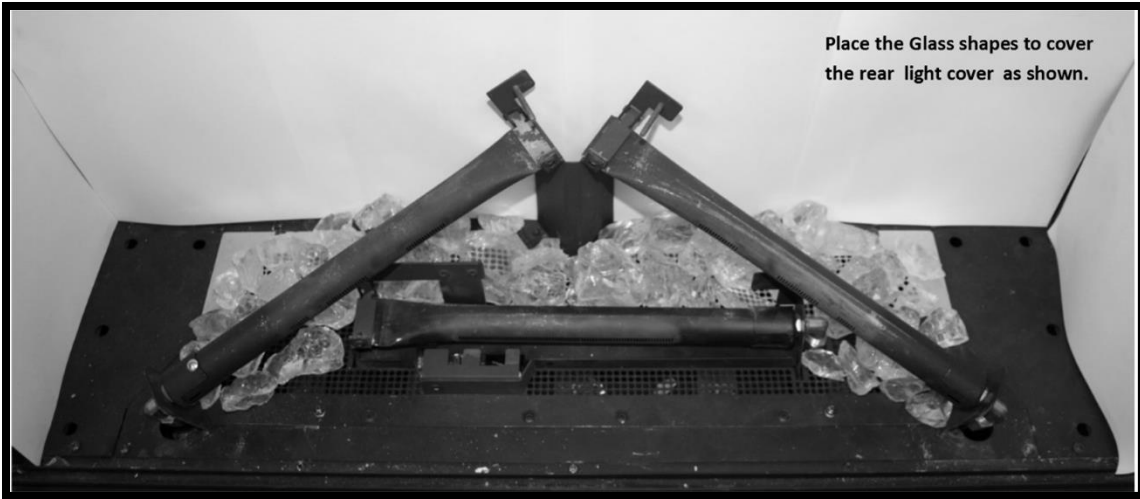

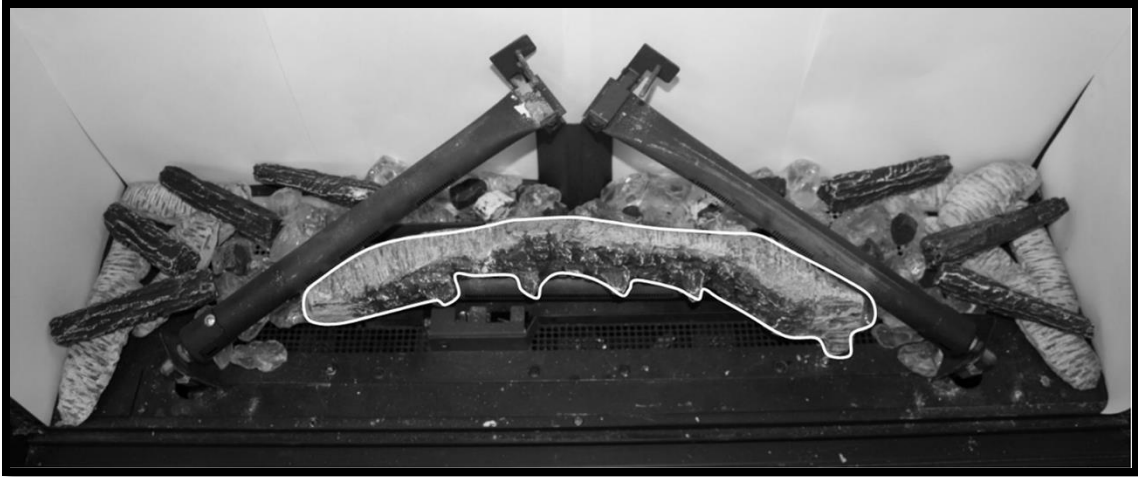

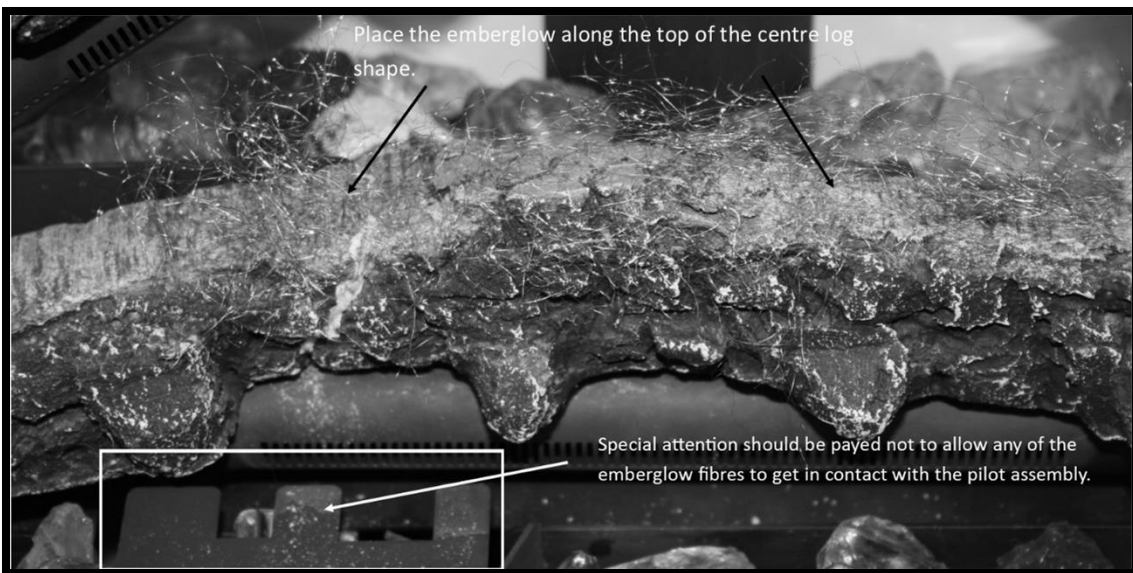

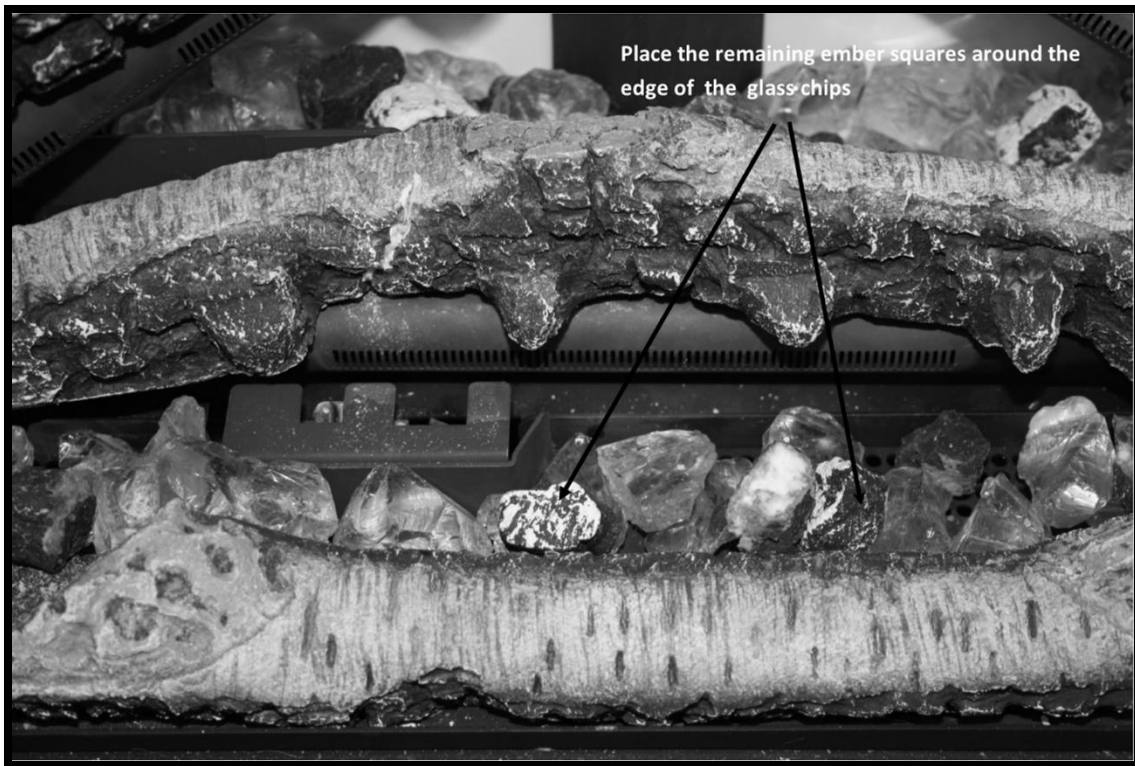
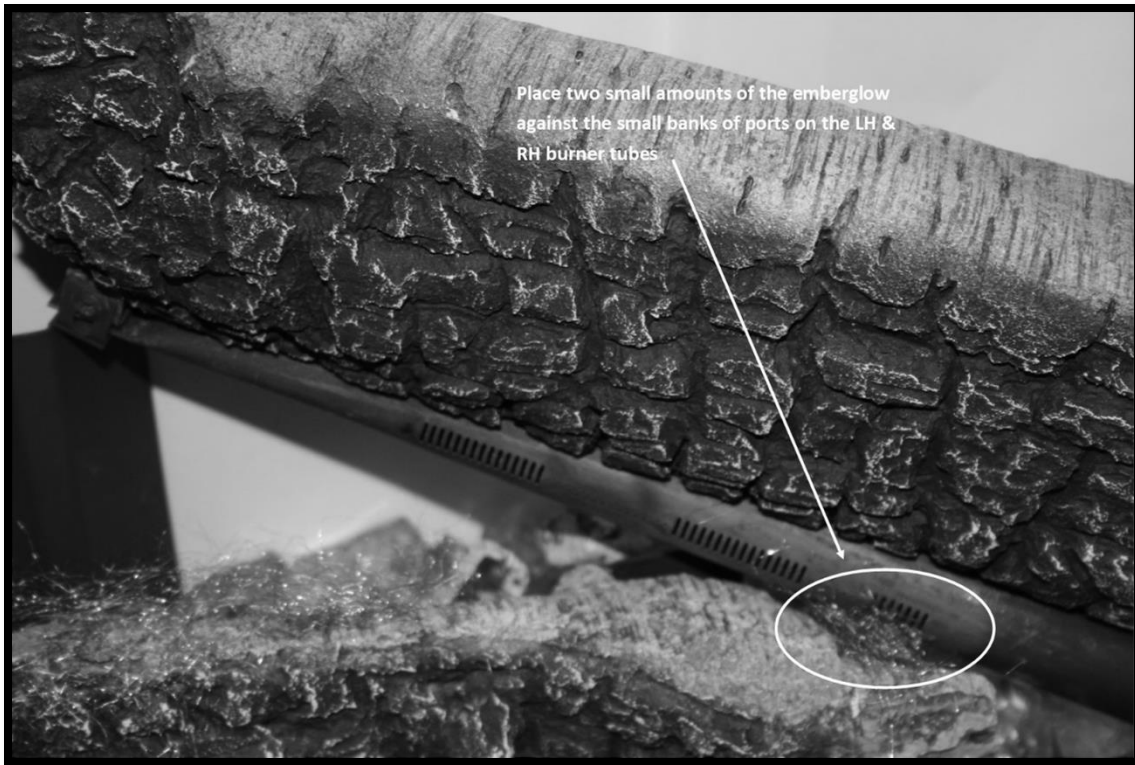

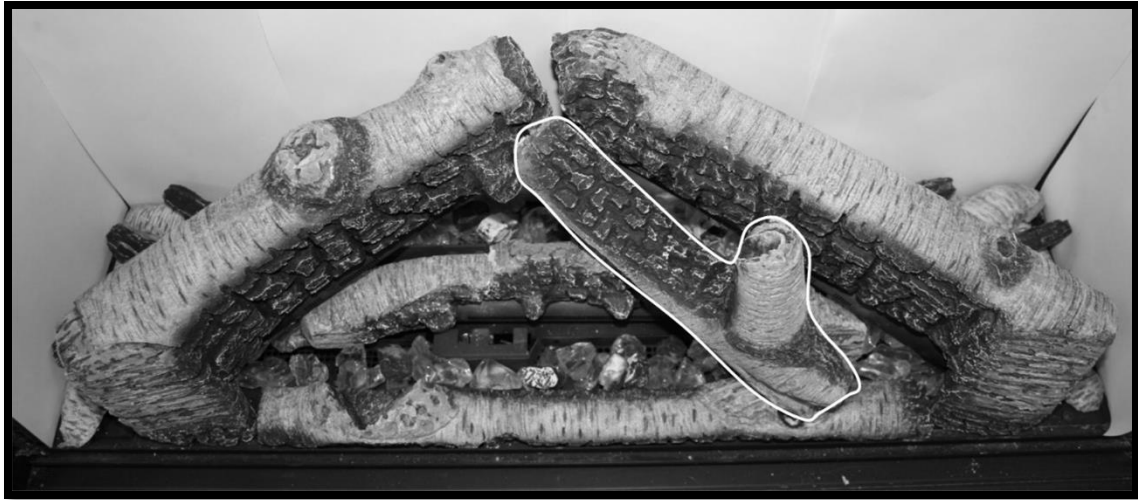

Technical Specification

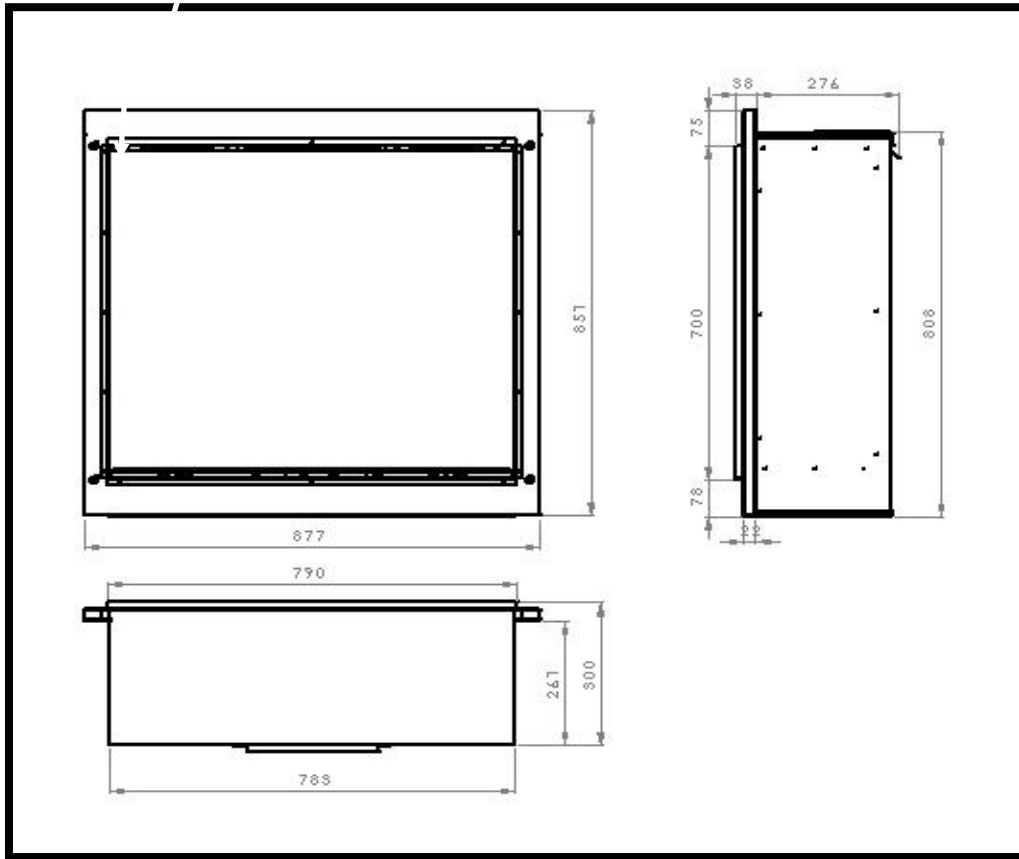

| Model | Gas CAT | Gas Type | Working Pressure | Front Injector | Rear Injector | Gas Input | NOX Class | Oxy Pilot | Country |
|---|---------|-------------|------------------|----------------|---------------|--------------|-----------|-----------|---------|
| 800 HD UBL | I2H | Natural Gas | 20 mbar | Mrk 120 | Mrk 220A | 7.7 KW Gross | 5 | 2900 NGR | GB, IE |
| 800 HD UBL | I3P | LPG | 37 Mbar | Mrk 72 | Mrk 79 | 7.1 KW Gross | 5 | SIT 9264 | GB, IE |
| Efficiency Class 1 | | | | | | | | | |
| Gas Inlet Connection Size 8mm | | | | | | | | | |
| Handset Replacement Batteries 4 x AAA 1.5V | | | | | | | | | |
| Power Supply Type Plug – Input : 100-240 VAC 50/60 Hz, 0.2A | | | | | | | | | |

Note : The efficiency of the appliance has been measured as specified in BS7977-1 2009+ A1:2013 and the net efficiency rate is 73.1% for natural gas and 76.0% for LPG. The gross calorific value of the fuel has been used for this efficiency calculation. Gastec have certified the test data from which it has been calculated. The efficiency value may be used in the UK Government's Standard Assessment Procedure (SAP) for energy rating of the dwelling. Within the appliance packaging will be an outlet restrictor, this is there to achieve the maximum efficiency. This, however may not be fitted due to the flue underperforming.

Note: restrictor plate screwed to the top of the fire is to be left on when fitting on a 5" flue subject to a spillage test. Additional 7" restrictor plate has been included to the box

| Packaging Check List |
|-------------------------------------|
| 1 x Glass Panel |
| 1 x Air Tray Assembly |
| 1 x Boxed Fuel Bed |
| 1 x Transformer Plug |
| 1 x Battery Holder |
| 1 x Emergency Power Battery Adaptor |
| 1 x RF Handset |
| 4 x AAA 1.5V Batteries |

Siting the Appliance

Regulation and warnings

This appliance must only be installed in Great Britain and Eire.

The appliance is suitable for use on natural gas or LPG.

When fitted in the GB the fire does not normally require purpose provided ventilation

In GB it is the law that all gas appliances must be installed by a competent person GAS SAFE registered installer, in accordance with the Current Gas Safe (installation and user) Regulations. All relevant parts of the local and national building regulations and all relevant recommendations of the following British standards. Failure to do so could lead to prosecution.

The following are relevant codes of practice and British Standards:-

B.S 5871

B.S 5440 Part 1 & Part 2

B.S 6891

This appliance must be installed to current versions of the above standards and include any relevant amendments to:-

The building regulations issued by the department of the environment.

The building standards (Scotland) (Consolidated) Regulations issued by the Scottish development office.

Eire the appliance must be installed by a competent person and installed in accordance with the current edition of I.S 813 document gas installation, the current building regulations and the current ETCI rules for electrical installation, if appropriate.

800 HD with UBL INSTALLATION INSTRUCTIONS

Prior to installation ensure that the local distribution conditions (identification of the type of gas and pressure) and adjustment of the appliance are compatible G20 @ 20 mbar or G31 @ 37 mbar.

The front of the fire act as a dress guard, conforming to BS 1945 (1971) and satisfies the heating appliance regulations (1991). However, a guard conforming to BS6539 (1984) must be used to protect young children, the elderly or infirm.

This appliance incorporates a safety device in form of an oxygen depletion system. It must not be adjusted or put out of operation. This is a non – serviceable item and must be exchanged as a complete assembly using only the original manufacturer's part.

A suitable proprietary fire surround with a 150 degree C minimum rating is required.

Class One

That is a conventional brick or stone chimney as used for a solid fuel appliance with an effective cross sectional dimension of 225 x 225mm or a lined flue with a minimum diameter of 125mm. The chimney must have a minimum effective height of at least 3 metres. Any permanent flue restriction or variable damper are to be removed or locked fully open. The chimney should be swept prior to installation if it has previously been used with a gas appliance or if it is a new installation.

The 800 HD with UBL is designed to be fitted into a class one flue with a fire place which will require a 50mm rebate. The other option is hole in the wall which can be plastered up to the edge of the fire place frame or fitted with wall mounted non-combustible slips. The two methods will require different size apertures.

Builder's opening aperture size when fitted in conjunction with a 50mm rebated surround

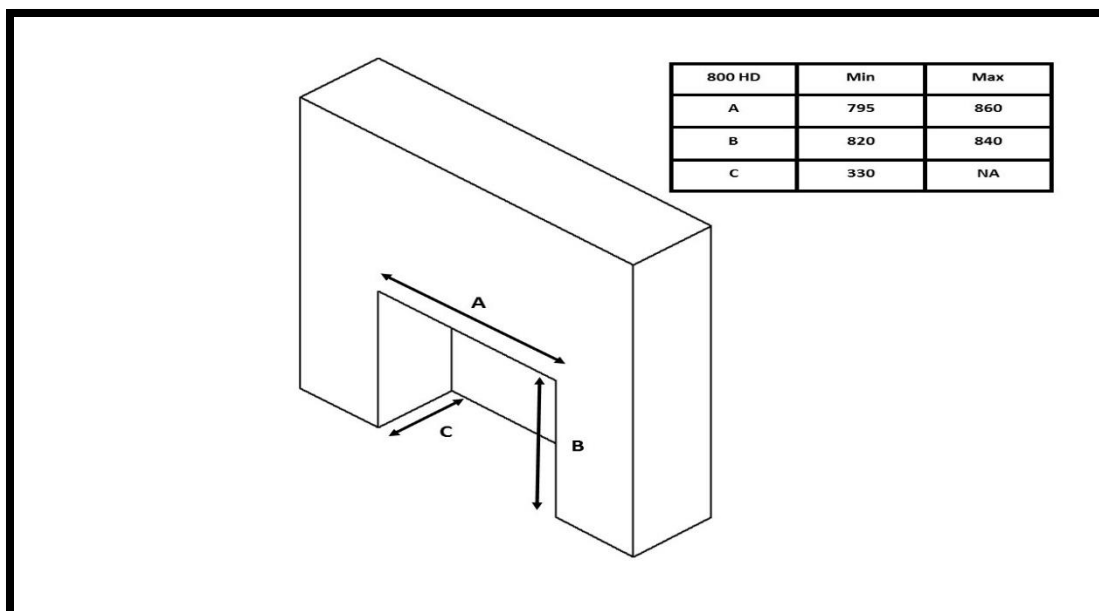

800 HD with UBL INSTALLATION INSTRUCTIONS

Open the firebox aperture as of the sizes stipulated in the previous section (50mm rebated surround). Please note the fire box height from the floor may well vary dependent on the fireplace surround design. Check the fireplace details first. Slide the fire box back into the catchment area and secure the fire box against the front face of the chimney breast. Fit the fire place frame to the fire box flange. The fireplace surround can now be constructed.

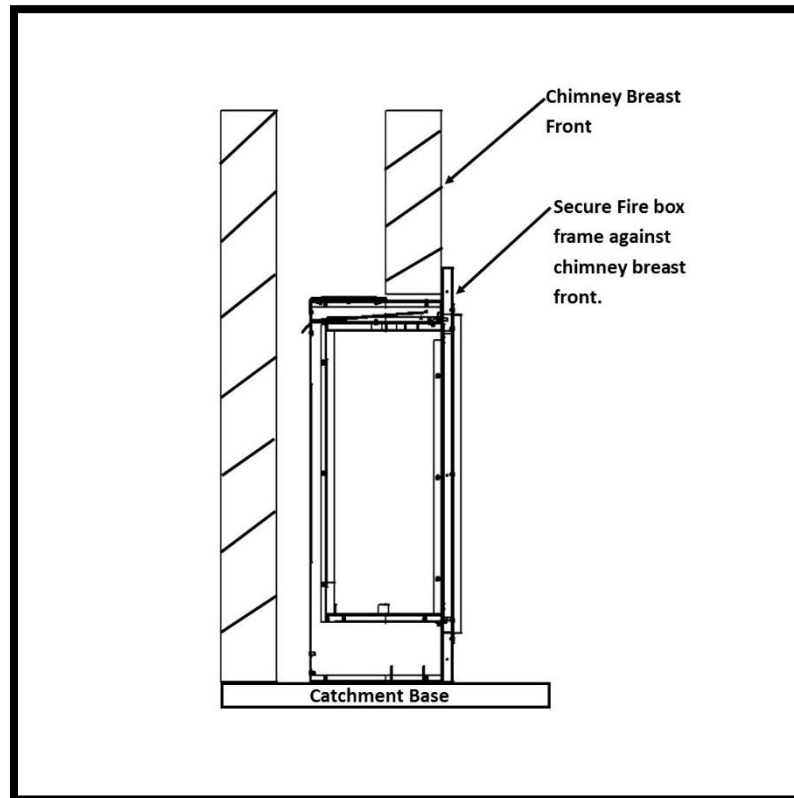

The 800 HD with UBL can be installed using three different methods when going hole in the wall.

A- Hole in the wall using none combustible slips.

B-Dry lined hole in the wall.

C-Wet plaster hole in the wall.

A- B-C / Builder's opening aperture size when fitting hole in the wall boarded edge or slips.

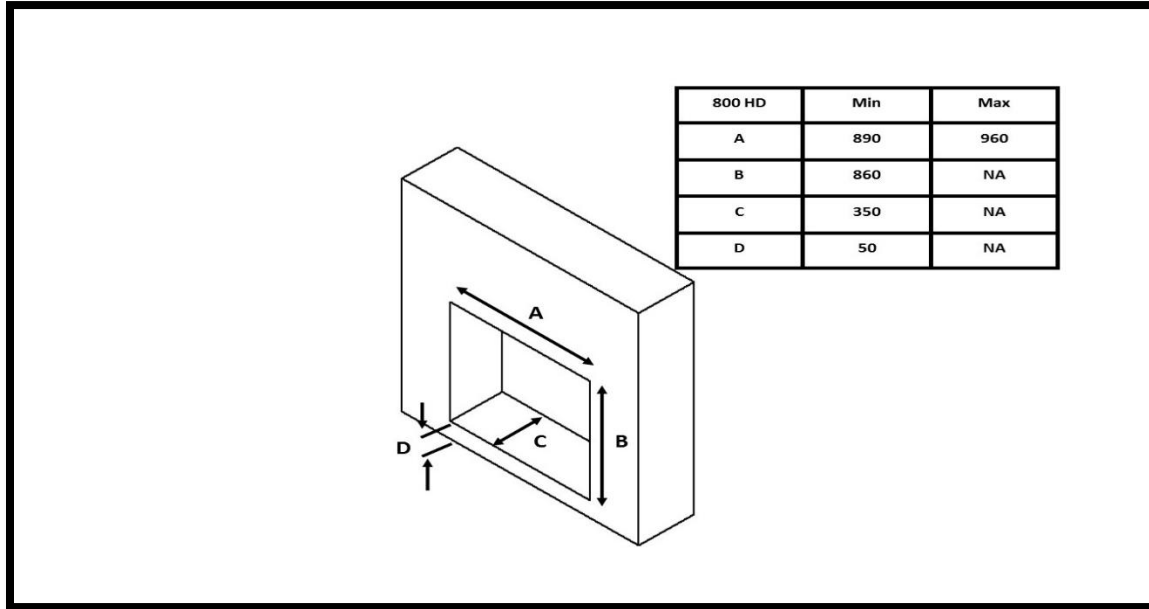

A-Hole in the wall using none combustible slips.

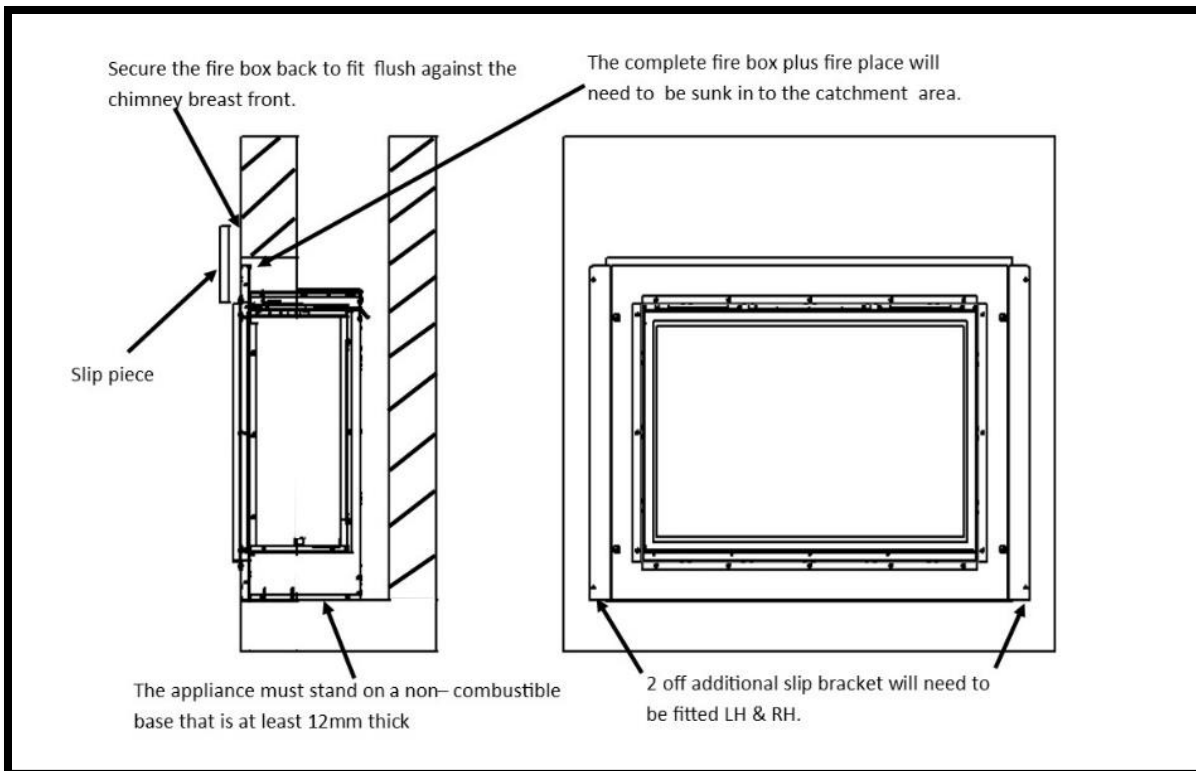

Using rawl plugs and wood screws retain the fire box via the 6mm holes within the slip brackets. None combustible slips can now be fitted up to the edge of the fire place frame.

B-Dry lined hole in the wall.

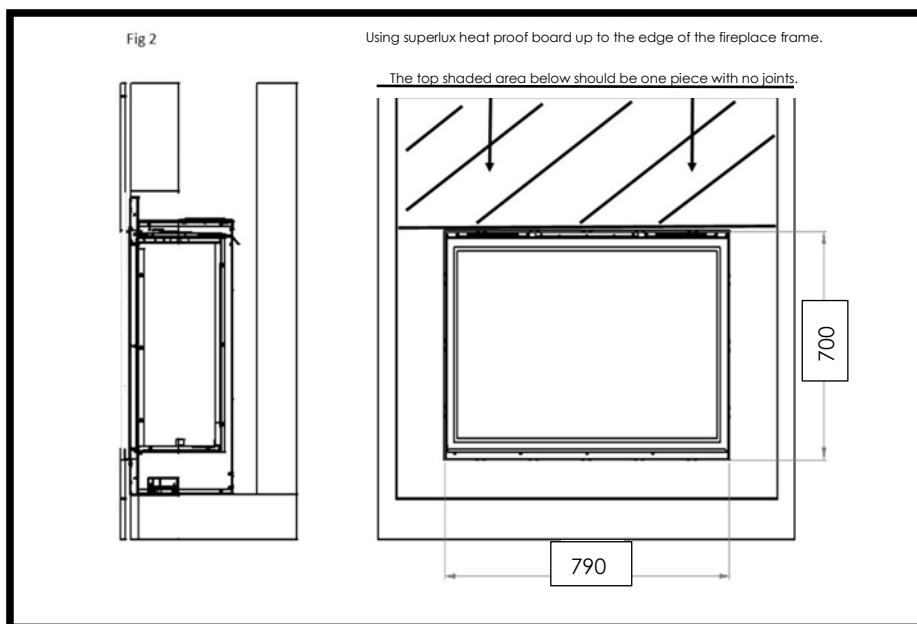
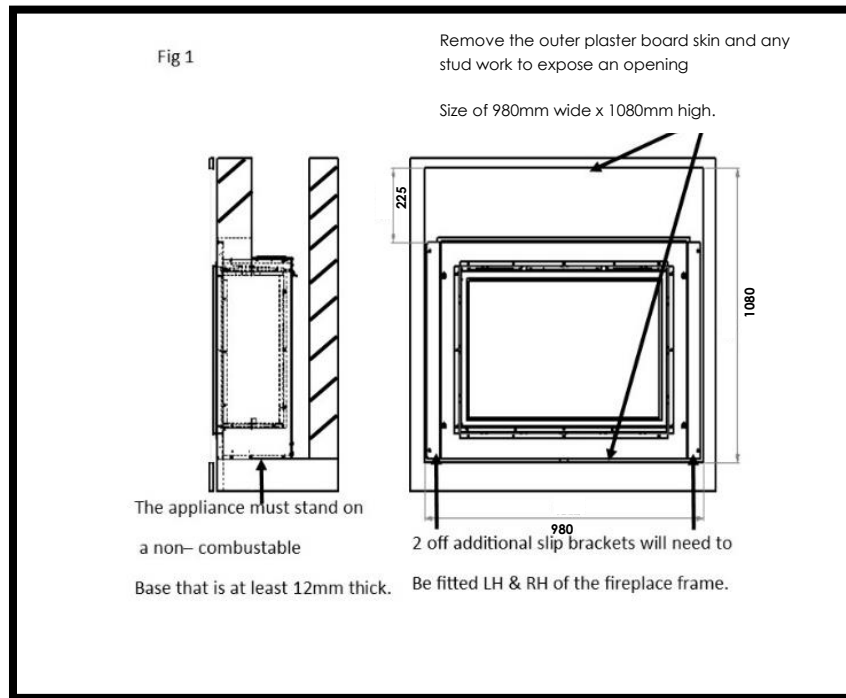

Open the aperture size to accommodate the fire box as out lined at the beginning of the section. With the height of the opening established and support for the fire box in place, take out a further area of the plaster board lining to expose the inner brick work face of the chimney breast as out lined in Fig 1.

The exposed area should be 1080mm from the base of the fire and 980mm in the width. With the slip bracket attached to the fireplace frame. Secure the fire box back against the inner brick work face of the chimney breast using rawl plugs and wood screws.

New plaster board can now be fitted to cover the exposed metal work, making sure that no plaster joints are positioned directly above the unit as highlighted in the Fig 2 above.

C-Wet plaster hole in the wall.

When the chimney breast front has been finished using wet plastered method and the total thickness of the bonding plus finishing plaster is less than 12mm. The following method will need to be applied.

Fit the fire box using the guidance stipulated earlier in the section when fitting the fire box with none combustible slips. With the fire box secured fit 15mm thick heat resistant board section to cover the complete front area of the chimney breast up to the forward projected edge of the firebox frame. Please note avoid any board joints directly above the unit.

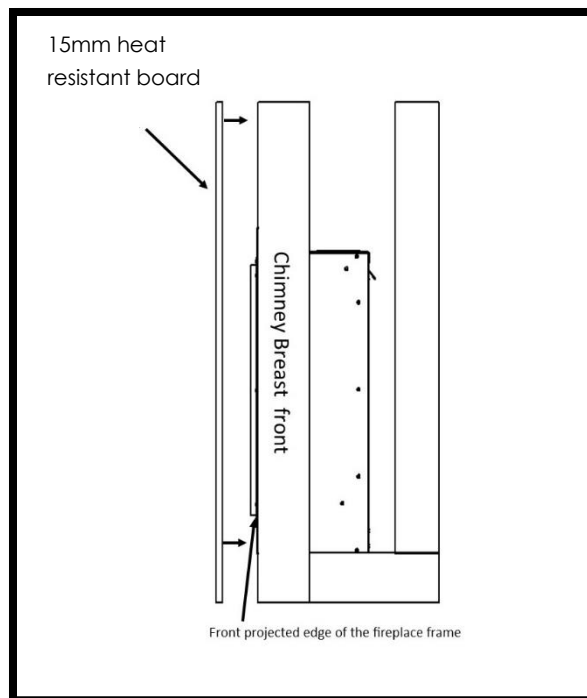

Checking the flue fire opening and fire opening.

Check that the chimney conforms to the required specification as previously stated. Examine the condition and carry out any remedial work including removing any debris from the base.

If the flue has been used for solid fuel it should be swept prior to installation.

Prior to installing the appliance a smoke test (using a bomb) should be carried out to check that satisfactory smoke clearance has been established. If all the smoke is not drawn into the flue, pre-heat the flue with a blowtorch or similar and retest. If there is any uncertainty examine for the cause and if necessary seek expert advice.

When installing the appliance against a dry lined plasterboard wall ensure that the void between the plaster board and wall is sealed with a non-combustible material.

No combustible material should be fitted inside the fireplace opening.

Installation with a flexible liner

The 800 HD with UBL is designed for installation within the masonry chimney with or without a flexible line.

If the flexible liner option is required the following two methods should be followed.

Method 1

A 125mm minimum diameter liner conforming to BS 715 may be used. Providing a suitable sealing plate is fitted to the base of the liner and the appliance does not restrict the opening into the liner. Ensure a smooth lead into the flue way and no combustible materials are used. A void of 50mm must be maintained from the top of the firebox into flue.

Method 2

Using the flexible liner gather hood (Part No A-0662). Using again 125mm minimum diameter liner conforming to BS 715, route the flexible liner within the masonry as of the requirements stipulated by the liner manufacturer.

Attach the gather hood to the liner using a suitable fixing at a height that clears the firebox assembly.

You will need to remove the entire burner tray assembly to be able to fit the gather hood. Remove the ceramic liners to access the inner and outer inspection plates situated within the rear of the fire box assembly (Please see Fig 1).

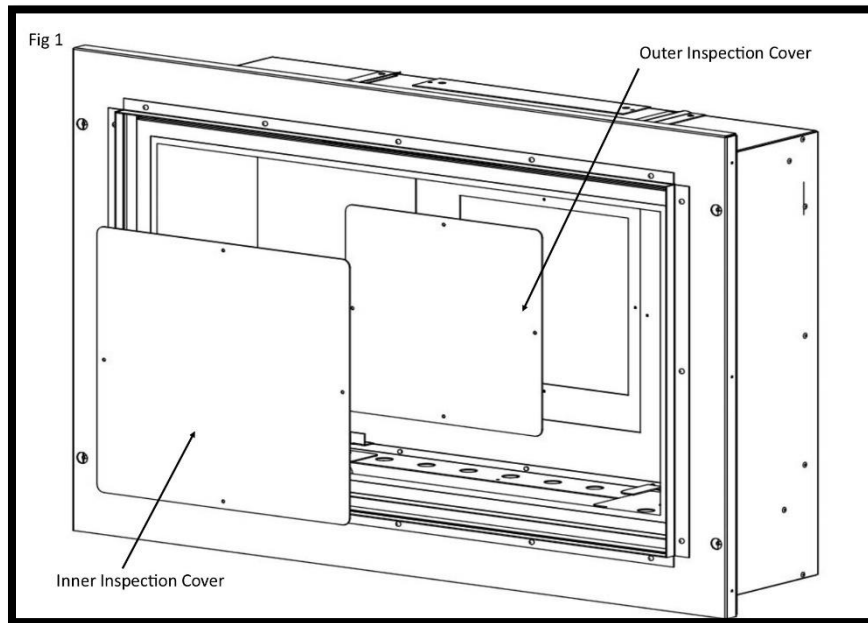

Offer the fire box assembly within the masonry aperture at the same time guiding the gather hood within the guides situated on the top of the fire box (Please see Fig 2). Engage the hood studs within the slotted holes and secure using the three M4 nuts provided within the gather hood kit.

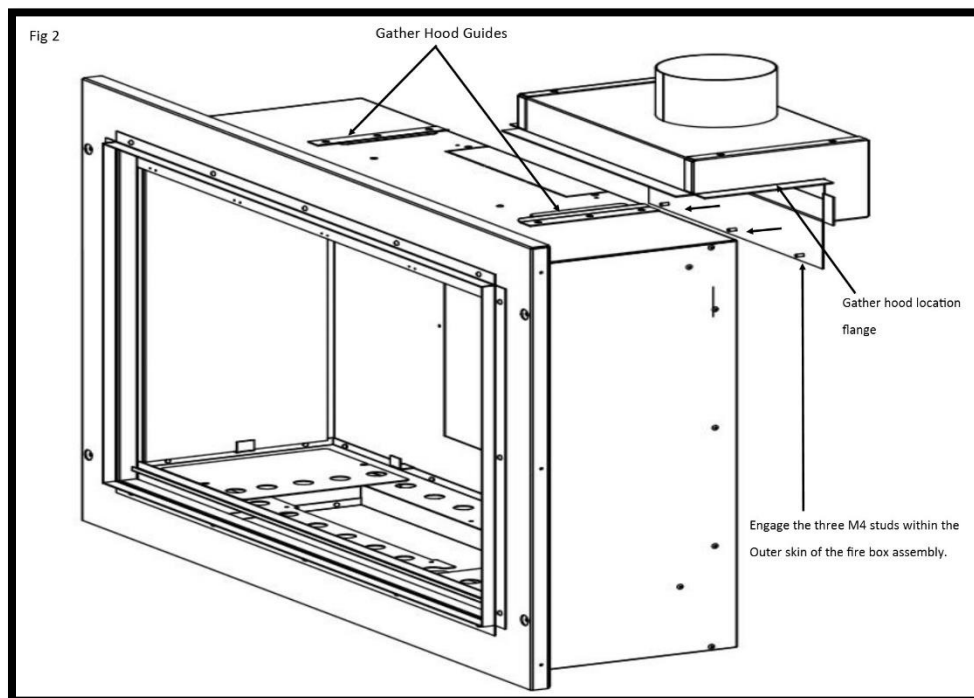

Gas supply routing.

Check the gas run to assess that the gas supply is capable of providing the required amount of gas and is in accordance with the rules in force.

Soft copper pipe can be used to install the appliance. Soldered joints can be used only externally of the appliance.

The appliance is supplied with a factory fitted isolation device to allow for an 8mm copper connection. No further isolation point is required.

The new gas line must be purged of any debris, prior to final connection to the appliance.

Gas inlet isolation device is located on bottom left hand side of the fire box, the gas supply entry point is positioned at the rear bottom on left hand side. With the appliance fixing kit is a 35mm round seal (Please see fig 3), this should be cut and fitted over the 8mm copper at the point the gas supply entry into the appliance assembly. The gas inlet cover will need to be removed to gain access to the connection. (Please see fig 4).

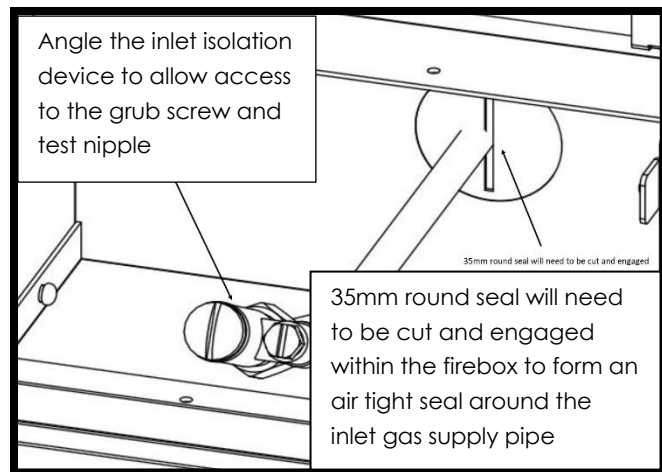

The gas inlet isolation device must be angled to allow access to the grub screw and gas test nipple. (Please see fig 3).

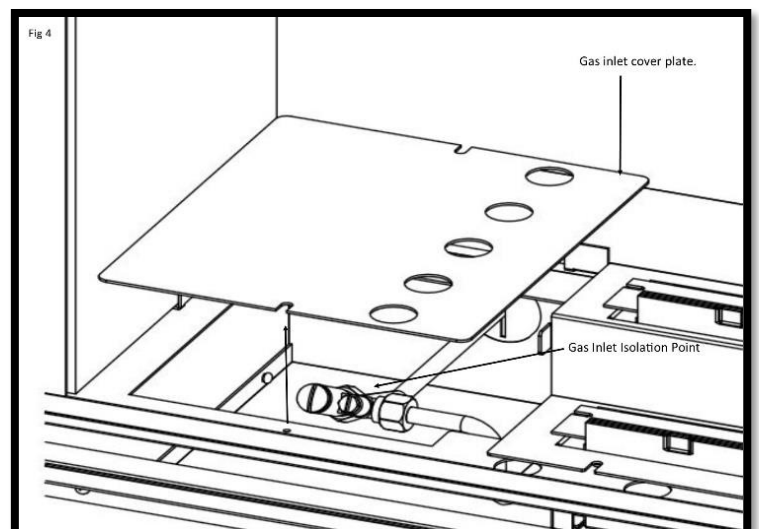

Power lead routing

The power supply for this appliance is provided via AC power adaptor 230 VAC. The main cable terminates at the rear Right hand side of the fire box. The length of the cable provided with the appliance is 1.65 metres. Care must be taken when siting the fire box not to trap the exposed main cable within the builders opening.

The cable can be routed using the following two methods,

Method 1

Passing the cable through the side of the chimney breast. It is good practice to run the cable within a sleeve of at least 15mm internal diameter, sealing the sleeve using a suitable sealant at the point the sleeve / cable terminates the chimney masonry.

Method 2

Remove a channel out of the outer skin of the Dry / wet plaster of the chimney breast up to the main power point. Again it is good practice to run the cable within a sleeve of at least 15mm internal diameter.

With power points that exceed the 1.65 metre distance, an optional 2.0 metre extension cable is available Part No 7147.

The cable system consists of retro fitting plug sockets which offers the following options. (Please see figure 5).

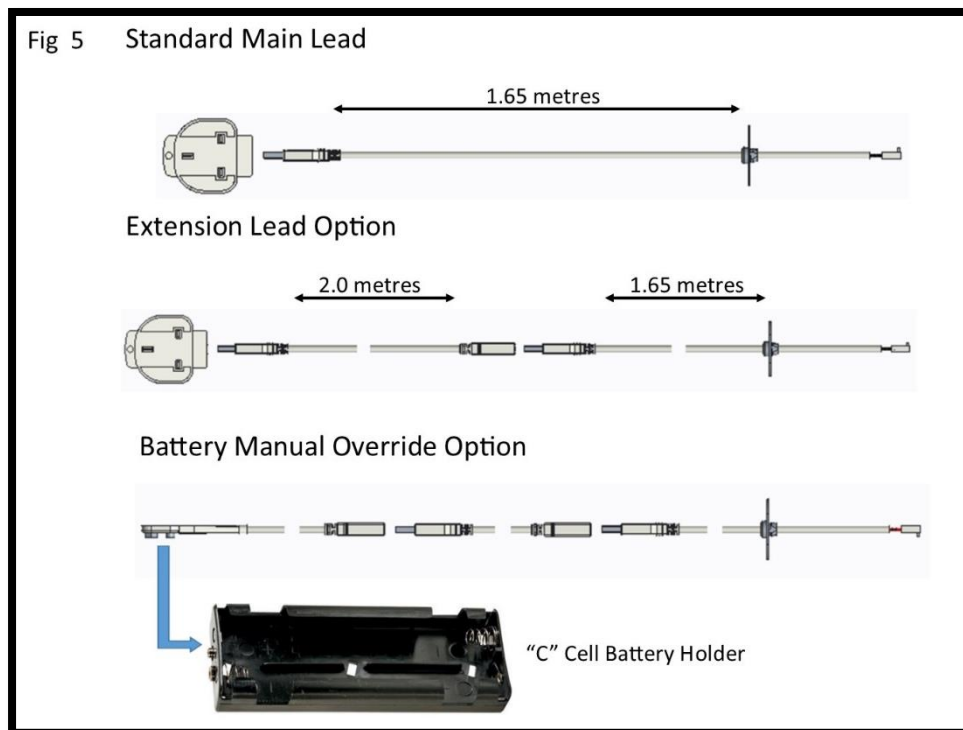

The battery manual override option is a backup supply in case of a power failure / power cut to the property. The battery holder and adaptor lead are provide within the packing of the appliance. (Please note that the "C" cell batteries are not included). It is good practice to demonstrate the battery option to the customer during the commissioning process.

Fire Box Installation

Note: - When installing the appliance with a 3 inch (75mm) rebated surround the optional 30mm spacer frame Part No 7571 will be required.

The fire box assembly can be retained using the following two methods.

Secure the firebox when fitted with 2 inch (50mm) rebated surround.

Using suitable rawl plugs and wood screws retain the fire box using the four 6mm holes within the firebox flange. With the fire box secured, slide the fireplace frame assembly over the four 4mm studs projecting forward from the fire box flange. Fix the frame to the fire box using the M4 nuts and the nut spinner provided within the appliance packaging. (Please see figure 6)

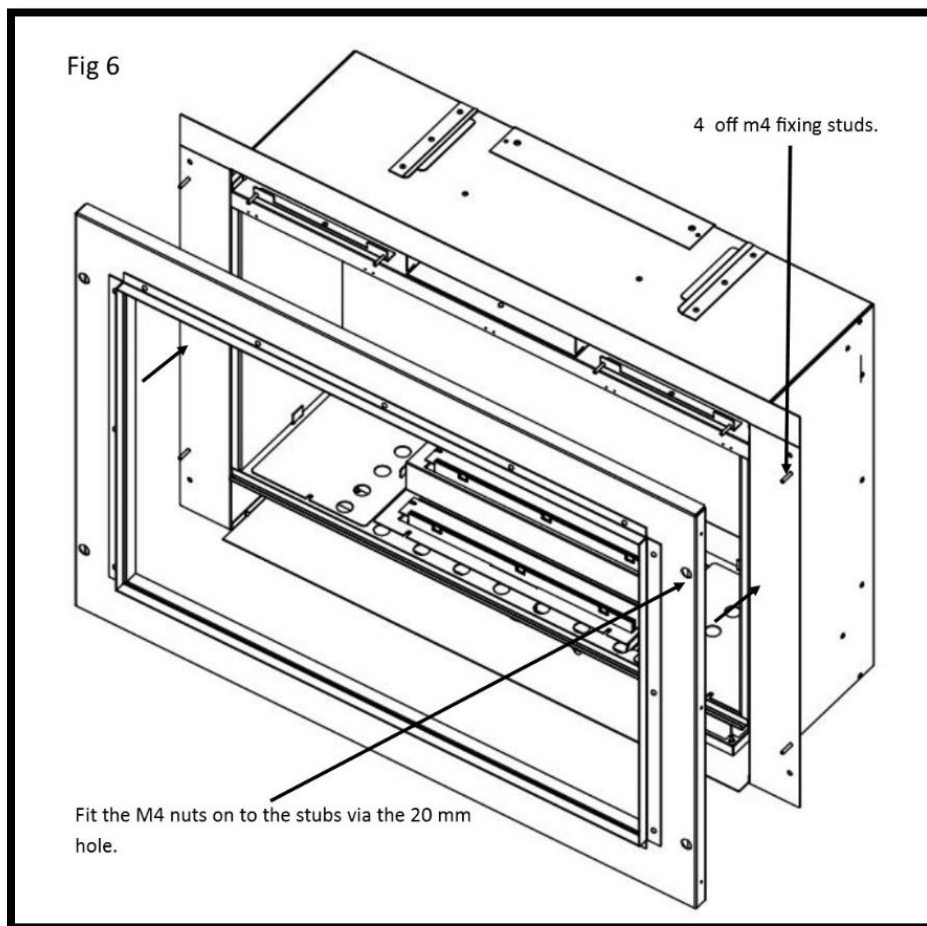

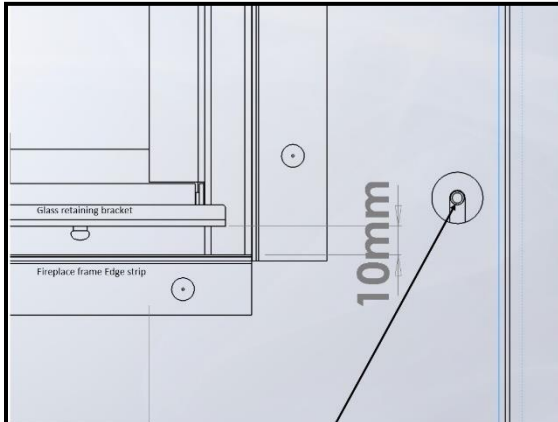

Keyhole slot must be fully engaged to maintain the 10mm clearance between the glass fixing bracket and the bottom internal edge of the fireplace frame

Important

When fitting the fireplace frame the studs need to be fully engaged to the top of the keyhole slot (as shown). If this is not fully engaged, it may cause ignition and outing issues

Hole in the wall.

For hole in the wall installation, two additional fixing brackets will be needed that are attached to the fireplace frame LH and RH. Attached the two brackets using the 6 off fixing screws provided with the kit. Secure the complete assembly using suitable rawl plugs and wood screws via two 6mm holes within the wall fixing brackets. (Please see Figure 7).

(Please Note). The fireplace frame is supplied with the slip guides attached. To improve the overall appearance of the appliance the guide brackets can be detached by removing the No 6 shelf tapping screws from within the fireplace frame assembly.

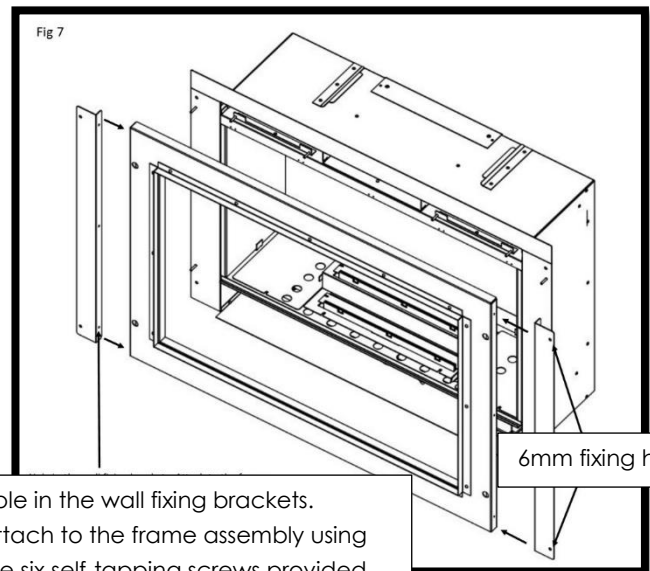
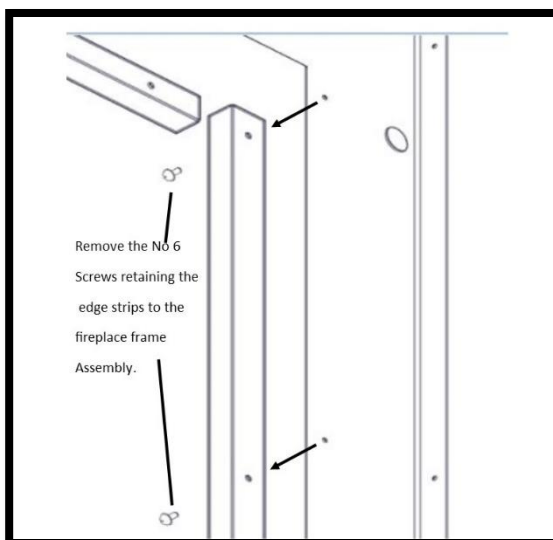

Hole in the wall fixing brackets. Attach to the frame assembly using the six self-tapping screws provided

Commissioning the Appliance

Checking gas soundness and running pressure.

Turn on the supply to the appliance and check for soundness in accordance with the current codes of practice.

Turn off the gas supply at the external isolation valve.

Remove the pressure test point screw from the inlet elbow and connect the pressure gauge.

Turn on the gas to the appliance at the isolation valve.

Light the appliance as described in the user instruction section. Page 5 turn on (startup).

Check the inlet pressure is 20 mbar +/- 1.0 mbar natural gas or 37 mbar +/- 1.0 mbar for LPG with other appliances running.

Turn off gas supply, at the isolation valve. Disconnect the pressure gauge and replace the pressure test point screw.

Turn on the appliance and check the pressure test point for soundness with detection fluid.

Refit the gas cover as shown in Fig 4(page 32).

Fuel Bed Layout.

Fuel bed layout should be fitted using the guidance stipulated on pages 13 - 21 of the User Instruction section.

Fit Glass Panel.

Due to transit protection, the glass panel is packed with a protective sleeve within the packed appliance. Special care should be taken when removing the glass panel from the packing. The

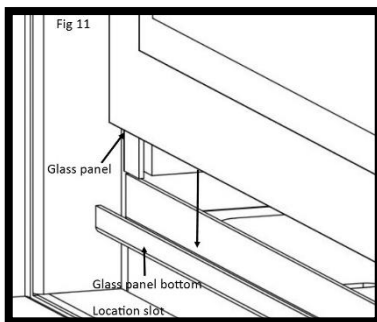

top fixing is attached to the fire box via 4 off M4 fixing nuts.

Remove the nuts and remove the top fixing bracket. (Please see fig 8 within the user instruction section on page 11).

Locate the glass panel within the bottom retaining slot and push back against the seals. (Please see Fig 11).

Position the top fixing bracket over the top edge of the glass panel and slide over the four M4 studs.

Using the four M4 nuts previously removed. Tighten the top glass fixing using the nut spinner provided with the appliance (be careful not to over tighten as this will crack the glass).

Spillage Test Procedure.

Light the appliance on maximum setting.

Close all the doors and windows.

After five minutes fit the smoke match within match holder and position as illustrated in Figure 13 with the head of the match just inside the inlet air channel.

Run the match along the edge of the inlet air channel. All smoke must be drawn into the inlet channel if the spillage test is satisfactory.

If spillage occurs wait a further five minutes and repeat the test.

Repeat the test with doors open and with any extractor fans in other rooms in operation.

If spillage is detected the cause must be discovered and the fault corrected. If the fault cannot be corrected, disconnect the fire from the gas supply and seek expert advice. Spillage can be caused by a restriction in the flue system, down draught or insufficient ventilation into the room where the fire is installed.

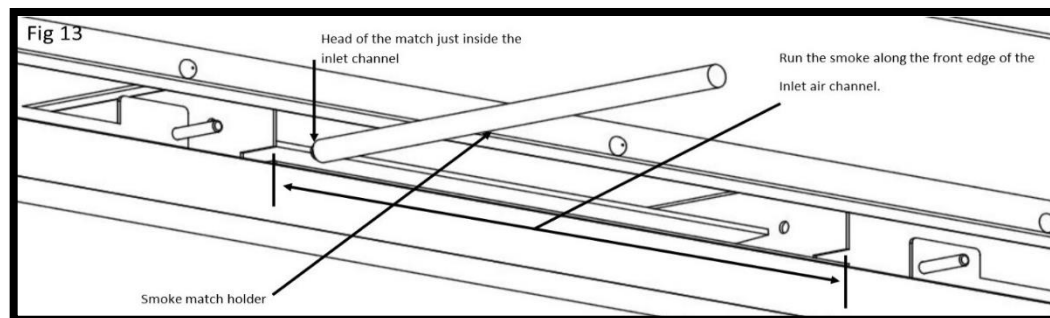

Non reflective glass option.

The non-reflective glass has no print on the glass due to this there is an inner frame provided to be fitted before the glass panel.

Slide the inner frame into the glass channel and push in to place ensuring the tabs are sitting on top of the firebox(see below) ensure the frame is central and there is an even gap either side of the frame (between the side of the firebox and the tabs of the frame)

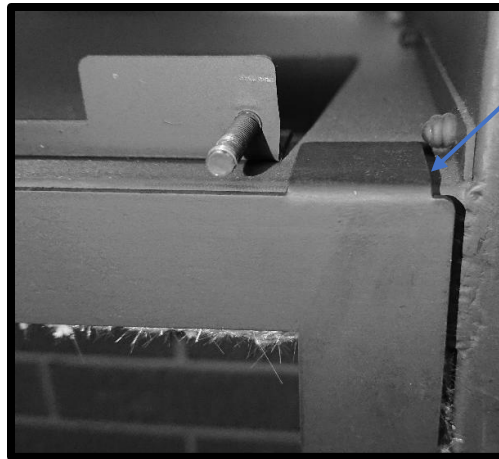

Make sure that the gap here is the same on both sides of the frame

Slide the glass in front of the frame and push in to place making sure that the glass is pushed in to the glass channel properly and sits in the bottom of it and that the inner frame is still central.

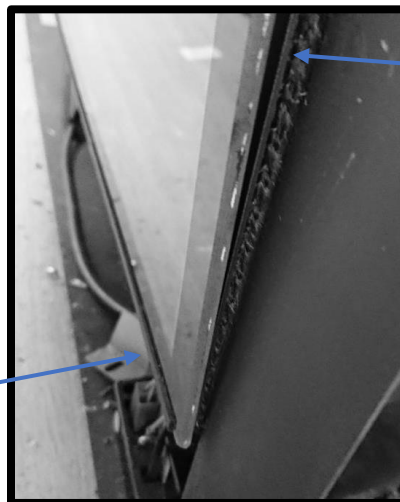

Push the glass in to place so it sits flat against the frame

Make sure that the glass is sat in the bottom of the glass channel

Position the top fixing bracket over the top edge of the glass panel and slide over the four M4 studs.

Using the two M4 nuts previously removed. Tighten the top glass fixing using the nut runner provided with the appliance being careful not to over tighten the glass as this will cause breakages.

Advise The Customer.

The glass front of this fire acts as a dress guard conforming to BS 1945 (1997) and satisfies the heating appliance regulations (1991) however; a fireguard conforming to BS6539 (1997) must be used to protect young children, the elderly, or infirm.

During initial "burn off", an odour may be evident during the first few hours of use. This is due to the surface coating on the metal work "burning off". The odour produced is harmless and will disappear after a short period of time.

Any debris should be cleared from the appliance.

The appliance should be serviced annually by a Gas Safe registered engineer in accordance with the Service instruction section.

Point out the position of the power source for the appliance, plus demonstrate using the additional battery holder and adaptor lead, the battery backup option. ("C" cell batteries not included within this appliance).

Demonstrate the lighting and extinguishing procedures to the user and the removal and refit of the glass panel for cleaning and the fitting of the battery backup kit.

Hand these instruction over to the user along with the battery holder, adaptor lead plus M4 nut spinner for the removal of the glass panel.

Please be aware that the non-reflective glass may in some lights and from some angles have a blue tinge to it this is perfectly normal.

It is a requirement that the gas fire is installed and commissioned to the manufacturer's instructions and the data fields on the commissioning checklist completed in full located at the back of the book.

Annual Service Requirement.

General

Servicing should be carried out annually by competent person whose name appears on the gas safe register. All Gas Safe engineers should possess an ID carrying the logo below.



Before commencing any service or replacement of part, turn off the gas supply to the fire. After servicing check for gas soundness.

When ordering spare parts please quote the appliance name and serial number.

This product should be serviced regularly to optimize its safety, efficiency and performance. The service engineer should complete the relevant Service Record on the Benchmark Checklist after each service at the rear of the book.

Check for debris

At least once a year check for debris in the catchment area behind the fire and in the flue way. To undertake this check the following procedure should be followed.

Remove the four M4 nuts fixing the glass clamp to the glass panel. (See Fig 8 on page 11). With the nuts removed, pull the glass clamp clear of the four studs. Finally lift the glass panel out of the bottom glass fixing.

Remove the log shapes.

Remove the four screws retaining the gas inlet plate and the ECU cover.

Shut off the restrictor elbow and disconnect the 8mm inlet nut.

Switch off the mains supply from the main supply plug socket.

Undo the M3 nut retaining the ECU unit and remove the connection bracket plus disconnect the mains supply cable from ECU.

Take out the four screws retaining the burner tray assembly and lift out of the fire box shelf taking care not to damage the panels.

Remove the two side liner fixing bracket LH & RH which are situated in the roof of the fire box assembly.

Carefully remove the LH & RH side panels.

Remove the rear panel from within the fire box.

Finally remove the eight screws from the inner and outer inspection covers. (Please see figure 1)

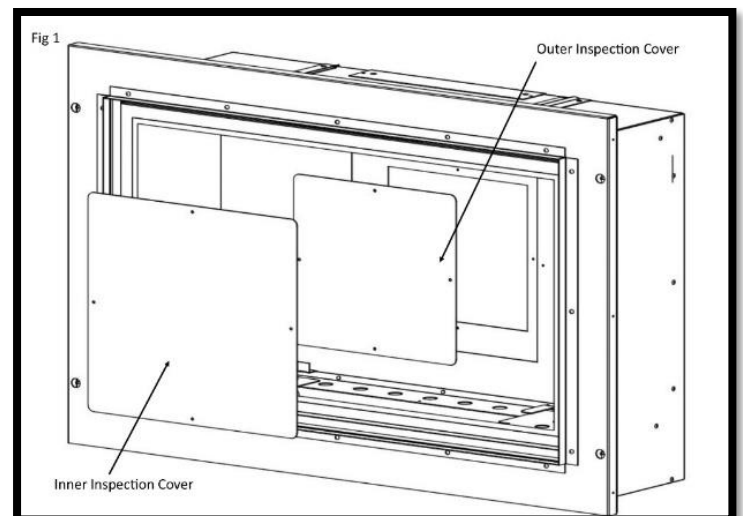

With the covers removed. The catchment area at the rear of the fire box can now be inspected for debris. With the aid of a mirror via the back of the box check the path of the flue for any restrictions.

Re-assemble in reverse order.

Pilot Linting

Check the pilot aeration hole for linting, use a vacuum clearer nozzle taking care not to damage the pilot head. Do not blow compressed into the pilot as this can lodge debris in the pilot body.

Electrode Gap

The electrode gap should be 4mm from the tip of the thermocouple probe head to the end of the electrode wire.

Spillage test

Follow the procedure stipulated on page 37 of the installation instruction section.

Fault Finding Charts

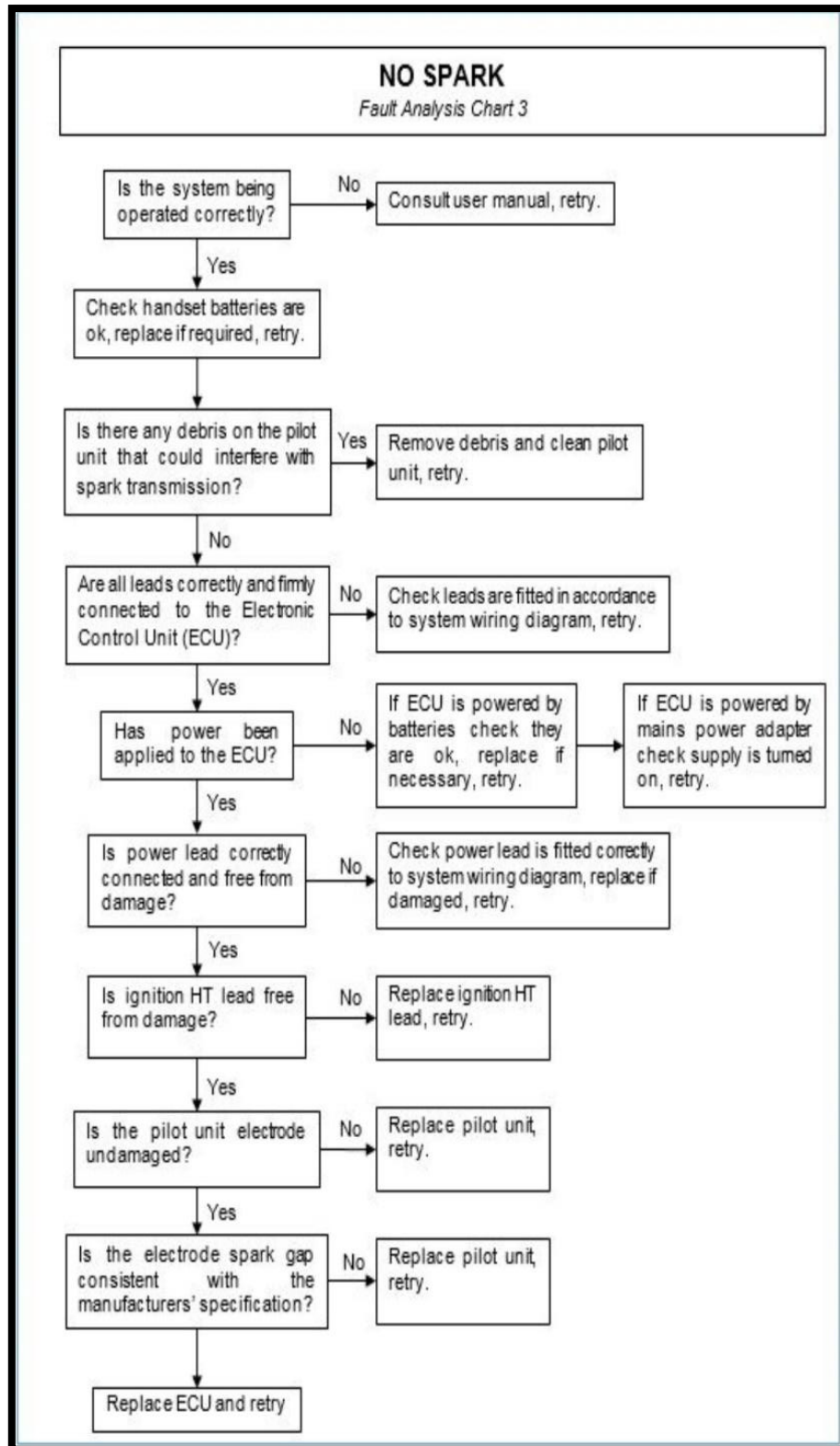

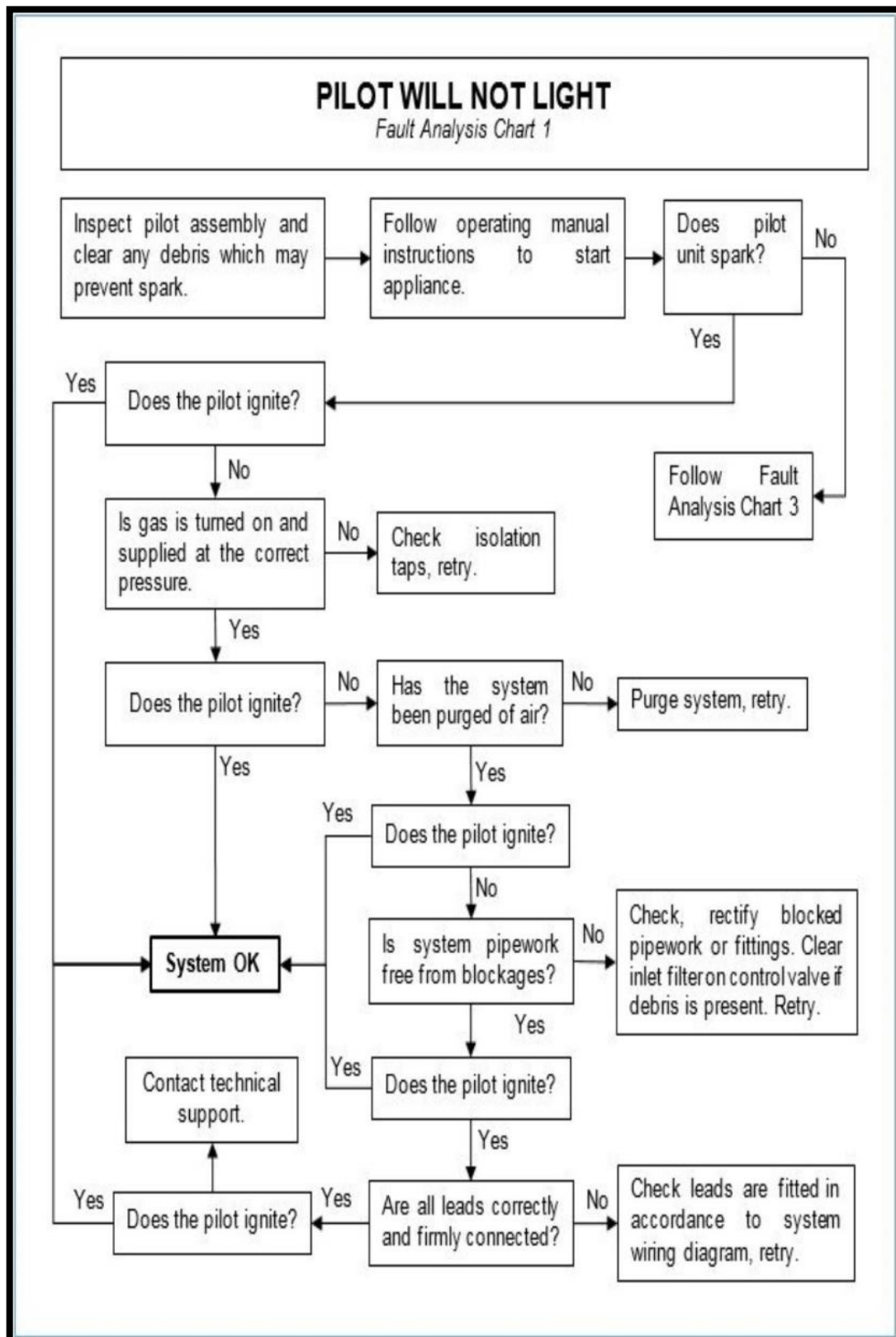

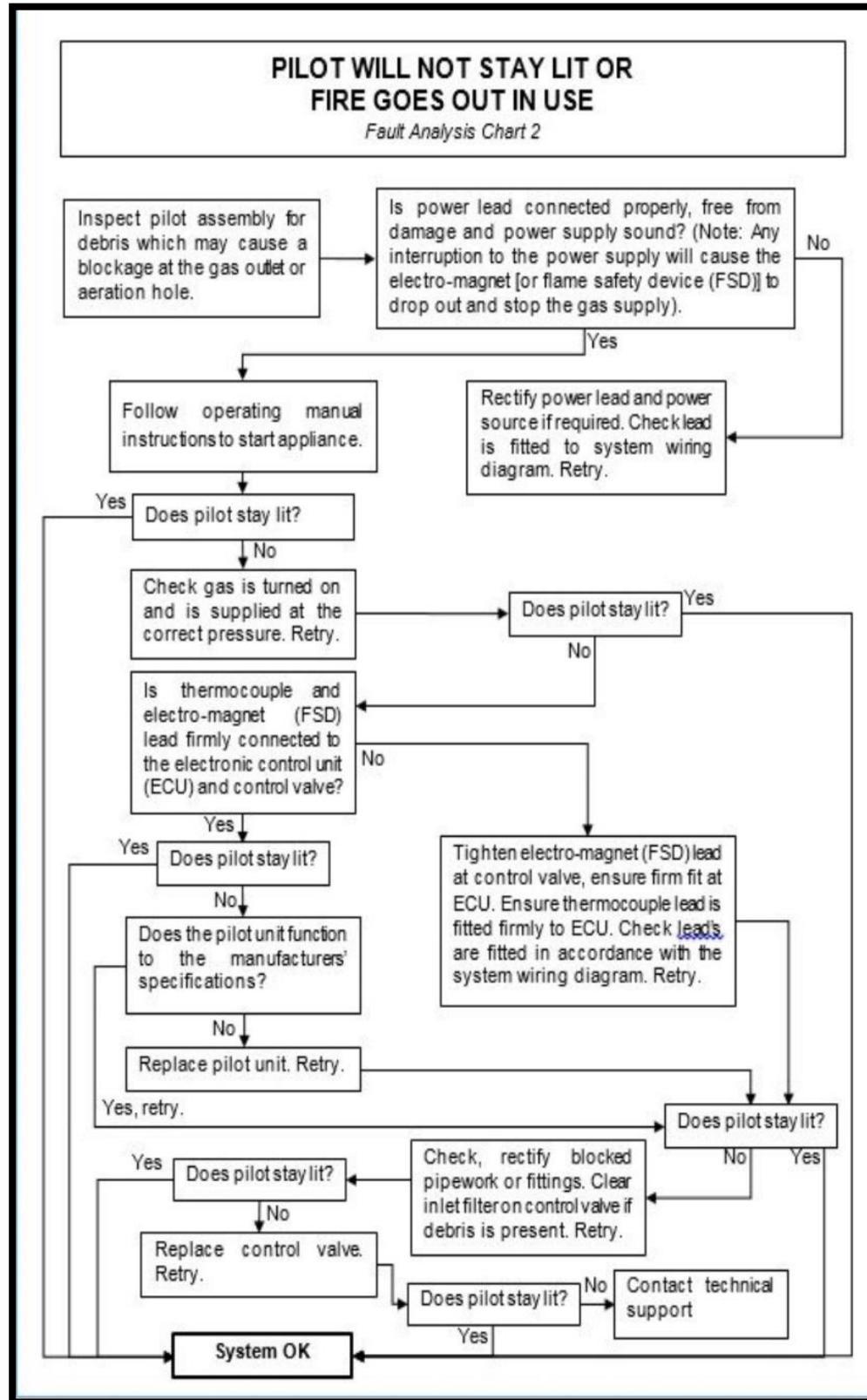

Wiring Diagram

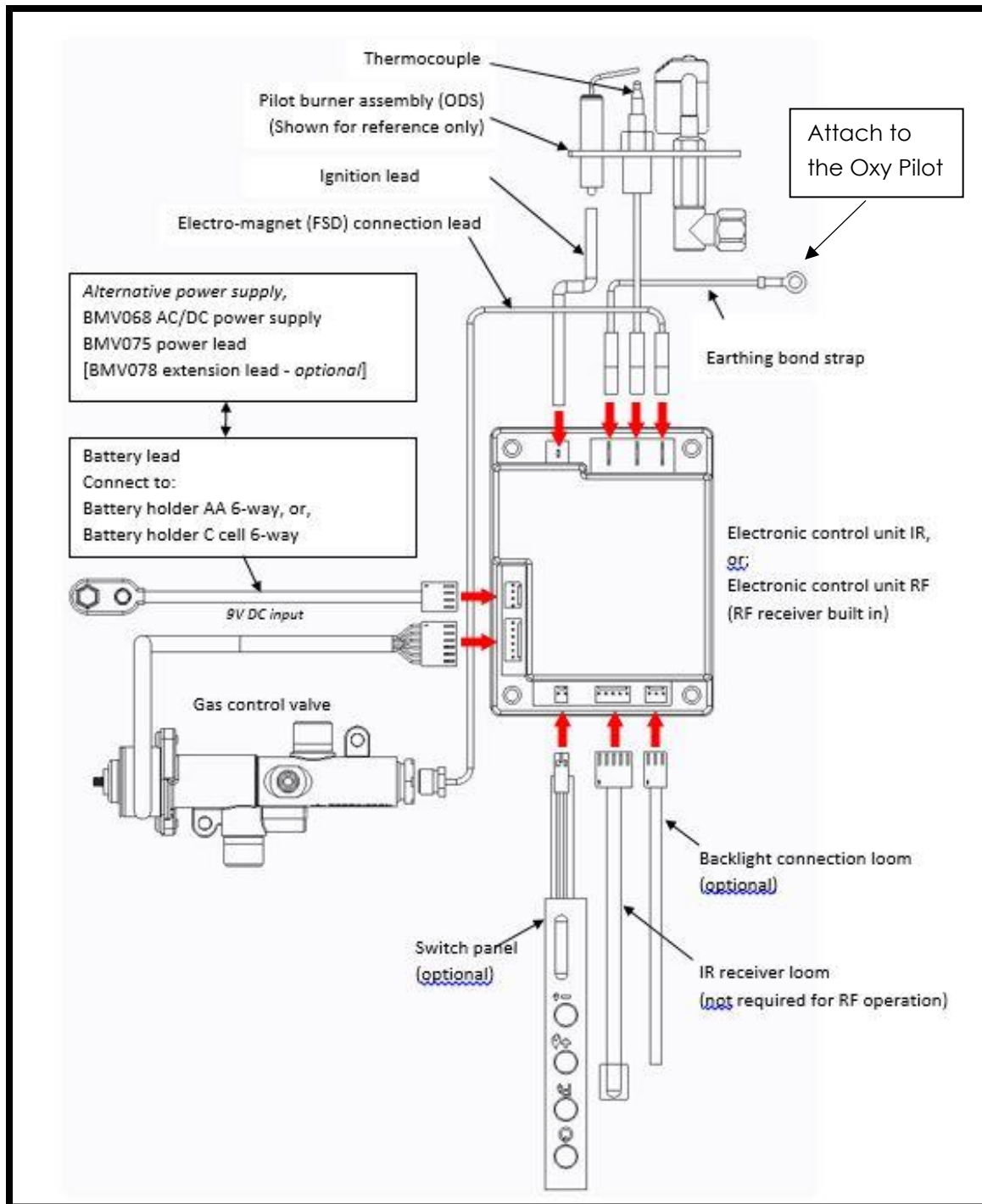

Maintenance

To Remove The Burner Carrier Assembly

Remove the glass panel as described on page 9 of the users instruction section.

Remove the Loose shapes.

Remove the four screws retaining the gas inlet plate and the ECU cover.

Shut off the restrictor elbow and disconnect the 8mm inlet nut.

Switch off the mains supply from the main supply plug socket.

Undo the M3 nut retaining the ECU unit and remove the connection bracket plus disconnect the mains supply cable connection.

Take out the four screw retaining the burner tray assembly and lift out of the fire box shelf taking care not to damage the panels.

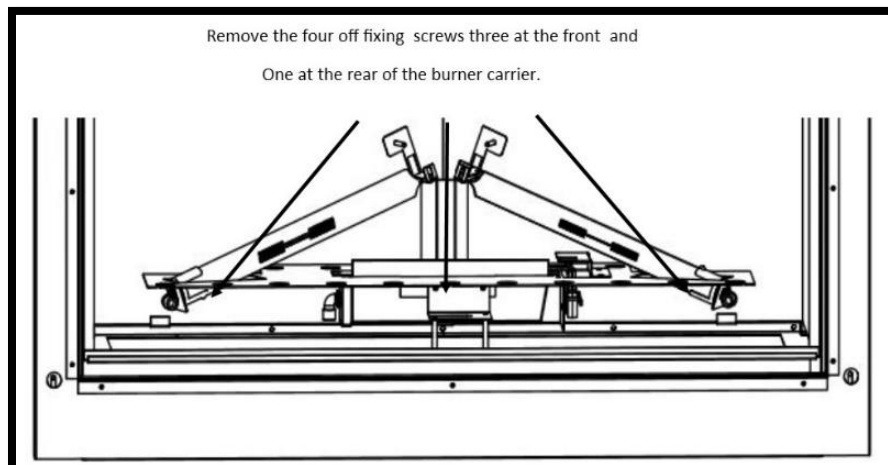
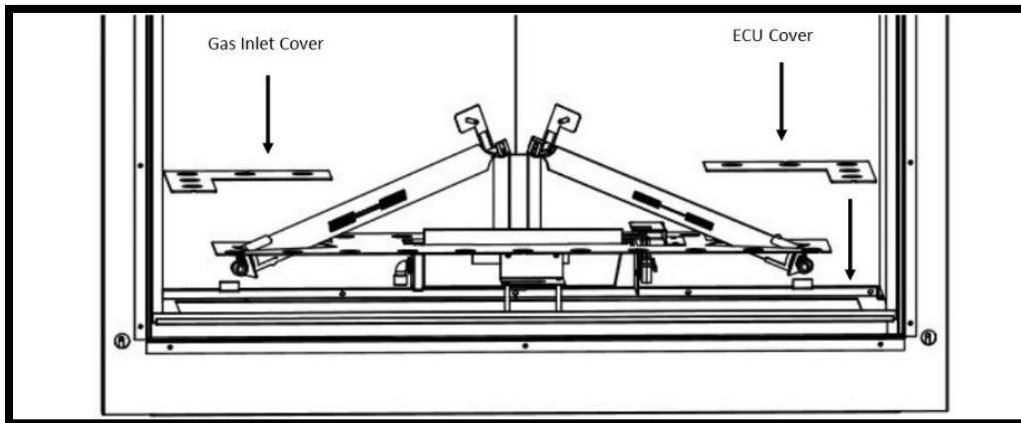

Replacement of the Gas Valve

Follow the sequence to remove the burner carrier assembly.

Disconnect the thermocouple from the rear of the gas valve.

Undo the three compression nuts securing the pipes to the gas valve and remove the two M4 nuts fixing the valve to the valve mounting brackets.

Clean, service or replace the gas valve.

Re-assemble in the reverse order.

Turn on the gas supply, check for soundness and re-commission the appliance.

Replacement of the Injectors

Follow the sequence to remove the burner carrier assembly.

Undo the compression nut on the supply pipe.

Remove the two screws retaining the burner assembly to the carrier and lift away from the injector.

Unscrew the locking nut holding the injector and silencer bracket on the burner carrier.

Remove injectors from assembly. Clean or replace injector.

Re-assemble in reverse order.

Replacement of the Oxy-Pilot Assembly

Note: If the pilot assembly is replaced it must be replaced by an identical unit from the same manufacturer and replaced as a complete unit.

Follow the sequence to remove the burner carrier assembly.

Undo the compression nut on the supply pipe at the pilot.

Carefully pull off the ignition lead.

Disconnect the thermocouple at the end of the gas valve.

Remove the two fixing screws attaching the assembly to burner carrier.

Re-assemble in the reverse order.

Replacement of the centre burner Assembly

Remove the glass panel as described on page 9 of the users instruction section.

Remove the Loose shapes.

Undo the two fixing screws retaining the burner assembly with the carrier.

Lift the burner clear of the silencer and injector tip.

Clean or replace the burner assembly.

Re-assemble in reverse order.

Replacement of the tube burner Assembly.

Remove the glass panel as described on page 9 of the users instruction section.

Remove the loose shapes

Undo the fixing screw retaining the burner tube to the centre bracket.

With the fixing pin remove, lift off the retaining bracket from the main assembly.

Finally disengage the burner tube from the injector tip.

Clean or replace the burner assembly.

Re-assemble in reverse order.

Replacement of the Electronic Control Unit (ECU)

Note: Please note when changing the Electronic Control Unit the handset will need to be re-paired to the handset.
(Please see replacement handset for pairing details)

Remove the glass panel as described on page 9 of the users instruction section.

Remove the Loose shapes and the air tray assembly.

Switch off the mains supply from the main supply plug socket.

Undo the two M3 nuts retaining the ECU unit and remove the connection bracket.

Unplug the connection from the ECU board.

Re-assemble in reverse order.

Replacement of the Under Bed Drive Board.

Switch off the mains supply from the main supply plug socket.

Remove the glass panel as described on page 9 of the users instruction section.

Remove the loose shapes.

Remove the ECU cover.

Remove the M3 nut retaining the UBL Drive Board.

Disconnect the three leads into the UBL Drive Board.

Replace and re-assemble in reverse order.

Replacement of the LED Strip.

Switch off the mains supply from the main supply plug socket.

Follow the sequence to remove the burner carrier assembly.

Remove the four M4 nuts retaining the front and rear light cover plates and remove.

This will now allow access to all five LED strips.

Remove the two off M3 nuts and washers.

Disconnect the cable connections from the LED strip Assembly.

Replace and re-assemble in reverse order.

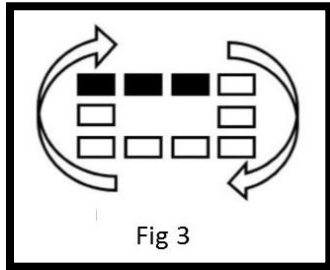

Fig 3





Fig 4



Replacement Handset





Follow the guide stipulated on page 7 of the users instructions "Changing the handset batteries" to load the batteries into the new handset.

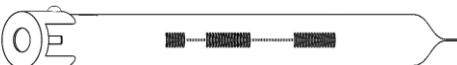

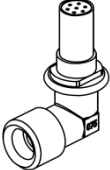
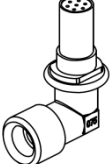
The replacement handset will need to be paired again to the ECU unit.

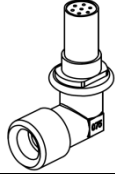
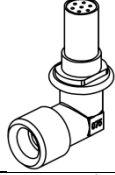
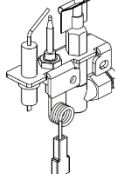
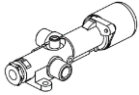
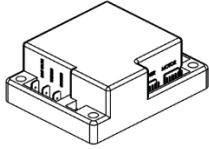
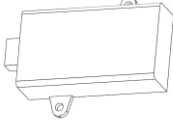
Press and hold  (approx. 5 seconds) until the menu graphic Completes (see Fig 3). This will access the menu (see Fig 4). Use the selector wheel and select the "gas fire" option. Press  &  simultaneously to delete the current channel. The handset will re-load to "NO DEVICE" see Fig 4) screen.

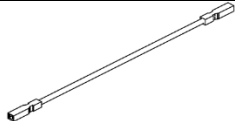
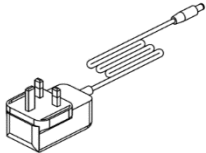
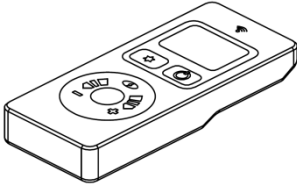
Short Spares List

| Image | Component | Part No |
|---|---------------------------|-----------------------------|
|  | Burner Tube | Center (7832) / Rear (7345) |
|  | Burner Tube LPG | Center (8200) / Rear (8199) |
|  | Front Injector Mrk 220 A | 6283 |
|  | Side Injector Mrk 120 x 2 | 7474 |

| | | |
|---|-------------------------------|------|
|  | Front Injector Mrk 72 | 8197 |
|  | Side Injector Mrk 79 x 2 | 8198 |
|  | ODS Unit (oxy Pilot) | 7280 |
|  | Control Valve | 6590 |
|  | Electrical Control Unit (ECU) | 7150 |
|  | LED driver | 7835 |
|  | LED Board | 7836 |
|  | Ignition Lead | 6646 |
|  | 9V transformer | 7145 |
|  | Handset RF | 7144 |
|  | Earth lead | 6593 |

| | | |
|---|------------------|--|
|  | Glass panel | NON-reflective: 7599 Standard: 7475 |
|  | Rear glass liner | 7725 Ceramic liner behind glass: 7723 |
|  | Side glass liner | 7726 Ceramic liner behind glass: 7724 |

Register your appliance online today to activate your warranty



GAS FIRE COMMISSIONING CHECKLIST

This Commissioning Checklist is to be completed in full by the competent person who commissioned the gas fire as a means of demonstrating compliance with the appropriate Building Regulations and then handed to the customer to keep for future reference.

Failure to install and commission according to the manufacturer's instructions and complete this Benchmark Commissioning Checklist will invalidate the warranty. This does not affect the customer's statutory rights.

| Site Requirements | Yes | N/A |
|---|-------------------------------------|-----|
| Was the chimney checked to ensure it only serves one flue/fire, has no obstructions and is continuous? | | |
| Has any debris at the base of the chimney been removed? | | |
| For brick chimney installations is there enough depth for 12 litres of debris, or precast flues 2 litres of debris? (see instructions for debris gap details) | | |
| Have damper and register plates been removed or locked in the fully open position ensuring correct size of flue is maintained? | | |
| If previously used for solid fuel has the chimney been thoroughly swept? | | |
| If the chimney is pre-cast has the inside of the flue been checked for extruded cement / sealant which must be removed? | | |
| Has the fire place been checked for under-floor air supply which must be sealed off? | | |
| Has the chimney been inspected prior to fitting the gas fire to ensure that it is in good condition? | | |
| Has the structure of the chimney been checked for leakage using a smoke pellet test? (See BS5440-1 for details). | | |
| Ventilation | | |
| Does the installation require any additional ventilation requirements as detailed in the manufacturer's instructions? | | |
| Hearth Requirements- where fitted | | |
| Is the hearth constructed from non -combustible material? | | |
| Is the hearth a minimum of 12mm thick with a minimum floor to top surface of 50mm?(BS5871) or as per manufacturer's instructions? | | |
| Is the hearth for open fronted fires a minimum of 760mm wide and has 300mm projecting from the fire opening (BS6871) or to manufacturer's instructions? | | |
| Mounting height (where applicable) has the fire been installed to the correct mounting height- as per manufacturer's instructions? | | |
| Firebox and Fuel Bed | | |
| Has the fuel bed, coals, pebbles etc. been fitted to manufacturer's instructions? | | |
| Gas Supply | | |
| Has an isolation tap/restrictor inlet elbow been fitted for servicing? | | |
| Has the gas supply been thoroughly purged prior to connection to remove any debris? | | |
| Has a gas tightness test been completed prior to breaking into the gas supply and following completion of installation?(IGEM/UP/1B) | | |
| Record burner gas pressure reading? If only the supply pressure is available a gas rate must be undertaken.(GSIUR REG26/9C) | | |
| Record dynamic inlet gas pressure (working pressure) reading (all gas appliances running) | | |
| Spillage test | | |
| Installation passes smoke match test with any extractor fans turned on (see manufacturer's instructions) | | |
| Installation | | |
| Has the gas fire been installed and commissioned in accordance with manufacturer's instructions? | | |
| Has the fire been installed with the correct clearance to combustible materials, as per manufacturer's instructions? | | |
| The operation of the appliance and controls have been demonstrated to the customer including battery replacement where applicable? | | |
| The manufacturer's literature, including Benchmark Checklist and Service record has been explained and left with the customer? | | |
| Has the appliance been registered with the Local Authority as detailed on the Gas Safe web site and is a legal requirement and forms part of the warranty? | | |
| Customer's Signature: (To confirm satisfactory demonstration and receipt of manufacturer's literature) | Commissioning Engineer's Signature: | |

* All installations in England and Wales must be notified to be Local Authority Building Control (LABC) either directly or through a Competent Persons Scheme. A Building Regulations Compliance Certificate will then be issued to the customer.

SERVICE RECORD

It is essential that your gas fire is serviced regularly and that the appropriate Service Interval Record is completed. Service Provider

Before completing the appropriate Service Record below, please ensure you have carried out the service as described in the manufacturer's instructions. Always use the manufacturer's specified spare part when replacing controls.

| | |
|-----------------------|-------|
| SERVICE 01 | Date: |
| Engineer name: | |
| Company name: | |
| Telephone No: | |
| Gas safe register No: | |
| Comments: | |
| | |
| | |
| Signature | |

| | |
|-----------------------|-------|
| SERVICE 02 | Date: |
| Engineer name: | |
| Company name: | |
| Telephone No: | |
| Gas safe register No: | |
| Comments: | |
| | |
| | |
| Signature | |

| | |
|-----------------------|-------|
| SERVICE 03 | Date: |
| Engineer name: | |
| Company name: | |
| Telephone No: | |
| Gas safe register No: | |
| Comments: | |
| | |
| | |
| Signature | |

| | |
|-----------------------|-------|
| SERVICE 04 | Date: |
| Engineer name: | |
| Company name: | |
| Telephone No: | |
| Gas safe register No: | |
| Comments: | |
| | |
| | |
| Signature | |

| | |
|-----------------------|-------|
| SERVICE 05 | Date: |
| Engineer name: | |
| Company name: | |
| Telephone No: | |
| Gas safe register No: | |
| Comments: | |
| | |
| | |
| Signature | |

Infinity 800 HD with UBL Packing List

| | | |
|--|---|-----------------------------|
| 800 HD with UBL NG | A-0709 – Glass liners fitted A-0718 – Red Brick liners Fitted A-0719 – Vermiculite liners Fitted | Pre- Fix RW |
| 800 HD with UBL LPG | A-0789 – Glass liners fitted A-0790 – Red Brick liners fitted A-0791- Vermiculite liners fitted | Pre- Fix TD |
| Data Badge On Plate | | |
| Burner Tray / Firebox Assembly | | |
| Air test Completed | | |
| Grommet (1092) | | |
| Glass Panel | | |
| Silicone Strip (4818) | | |
| Liners sides / rear / top | | |
| AAA Batteries | | |
| Remote Control Handset | | |
| Handset holder (7191) | | |
| Owners Book | | |
| Top Glass Retaining Bracket Fitted | | |
| Nut Spinner (5435) | | |
| Side Liner Retaining Brackets Fitted x 2 | | |
| Oxy – pilot Gap Checked | | |
| Mains Lead Fitted | | |
| 5" restrictor plate fitted | | |
| Restrictor Plate With Label | | |
| EmbaGlow (NATURAL GAS ONLY) | | |
| C Cell Battery Holder | | |
| 9v Transformer | | |
| Bag of fixings | | |
| Serial No | | |
| Inspector | | |



Charlton and Jenrick Ltd

Unit D

Stafford Park 2

Telford

Shropshire

TF3 3AR