

# Owner's Manual

INCLUDES

User, Maintenance, Service, and Installation  
Instructions



## PARAGON 2000 Plus & 2000 Plus Low Lintel SLIDE CONTROL



Keep this booklet for service log and future reference

### IMPORTANT



This appliance is guaranteed for 12 months subject to conditions. The 5 year extended parts warranty will only be valid if the annual service recommended in this manual has been completed and appliance has been registered online.

For use in Great Britain and Ireland.

Literature NO 5049 (ISS 2)

## Contents

|   |           |
|---|-----------|
| EXTENDED FIVE YEAR PARTS WARRANTY .....                                       | 2         |
| Benchmark Scheme .....  | 3         |
| <b>SECTION ONE Introduction (user instructions) .....</b>                     | <b>5</b>  |
| <b>SECTION TWO Operation (user instructions) .....</b>                        | <b>6</b>  |
| <b>SECTION THREE Fuel Bed Cleaning and Layout (user instructions).....</b>    | <b>7</b>  |
| <b>SECTION FOUR Important Information (user instructions).....</b>            | <b>12</b> |
| <b>SECTION FIVE Specification (installation instructions) .....</b>           | <b>14</b> |
| <b>SECTION SIX Regulations and Warnings .....</b>                             | <b>15</b> |
| <b>SECTION SEVEN Siting the Appliance (installation instructions).....</b>    | <b>16</b> |
| <b>SECTION EIGHT Fireplace Requirements (installation instructions).....</b>  | <b>18</b> |
| <b>SECTION NINE To Install the Appliance (installation instructions).....</b> | <b>19</b> |
| <b>SECTION TEN Maintenance Instructions (maintenance instructions) .....</b>  | <b>24</b> |
| <b>GAS FIRE COMMISSIONING CHECKLIST.....</b>                                  | <b>30</b> |
| <b>SERVICE RECORD.....</b>  | <b>31</b> |



## EXTENDED FIVE YEAR PARTS WARRANTY

In order to validate your extended 5 years parts warranty please read the Benchmark Scheme on the opposite page and ensure your installer has filled in the appropriate checklist.

**This in no way reduces your statutory rights**

Your warranty commences from the date of purchase and you must retain your receipt or invoice as proof of a purchase date.

THIS EXTENDED WARRANTY SPECIFICALLY EXCLUDES GLASS AND SOFT REFRACTORY COMPONENTS, THE BULB AND ANY BATTERIES.

### Terms and Conditions

1. The appliance must be installed by a GAS SAFE registered person.
2. The appliance must be used in accordance with the user's instructions.
3. The appliance must be serviced annually by a GAS SAFE registered person.
4. The benchmark and service log must be correctly filled out and the record of annual services must be up to date and supported by receipts in each case.
5. This warranty is not transferable and relates to the original installation only.
6. The appliance has not been subjected to misuse or accident or been modified or repaired by any person other than the authorised employee or authorised representative of Charlton and Jenrick Ltd.
7. The registration form must be returned within 1 month of purchase.

**Technical Help Desk 01952 200 444**



Charlton and Jenrick Ltd is a licensed member of the Benchmark Scheme which aims to improve the standards of installation and commissioning of domestic heating and hot water systems in the UK and to encourage regular servicing to optimise safety, efficiency and performance. Benchmark is managed and promoted by the Heating and Hotwater Industry Council. For more information and the full code of practice please visit [www.centralheating.co.uk](http://www.centralheating.co.uk)

Please ensure that the installer has fully completed the Benchmark Checklist on the inside back pages of the installation instructions supplied with the product and that you have signed it to say that you have received a full and clear explanation of its operation. The installer is legally required to complete a commissioning checklist as a means of complying with the appropriate Building Regulations (England and Wales).

All installations must be notified to Local Area Building Control either directly or through a Competent Persons Scheme. A Building Regulations Compliance Certificate will then be issued to the customer who should, on receipt, write the Notification Number on the Benchmark Checklist.

This product should be serviced regularly to optimise its safety, efficiency and performance. The service engineer should complete the relevant Service Record on the Benchmark Checklist after each service.

The Benchmark Checklist will be required in the event of any warranty.

It is a requirement that the gas fire is installed and commissioned to the manufacturer's instructions and the data fields on the commissioning checklist completed in full.

To instigate the guarantee, the gas fire needs to be registered with the manufacturer within one month of the installation.

To maintain the guarantee, it is essential that the gas fire is serviced annually by a Gas Safe registered engineer. The service details should be recorded on the Benchmark Service Interval Record and left with the householder.

### **Important**

For future reference we suggest you record the following details here, and keep the receipt as proof of purchase. This information may be asked for when you contact the helpdesk.

|               |                      |                   |  |
|---------------|----------------------|-------------------|--|
| <b>MODEL:</b> | <b>2000 Plus S/C</b> | <b>Serial No.</b> |  |
|---------------|----------------------|-------------------|--|

This information can be found on the label attached to the packaging and on the data badge, which is located on the base of the appliance behind the control cover.

|                          |  |
|--------------------------|--|
| <b>Retailer Name:</b>    |  |
| <b>Address:</b>          |  |
|                          |  |
| <b>Date Of Purchase:</b> |  |

### **Installer information required to register for the extended warranty**

|                              |  |
|------------------------------|--|
| <b>Name:</b>                 |  |
| <b>Date of installation:</b> |  |
| <b>Gas safe number:</b>      |  |

## SECTION ONE Introduction (user instructions)



### **Consumer Protection Information**

As manufacturers and suppliers of heating products, we take every care, as far as is reasonably practicable, that these products are so designed and constructed as to meet the general safety requirement when properly used and installed. To this end, our products are thoroughly tested and examined before despatch.

**IMPORTANT NOTICE:** Any alteration that is not approved by the appliance manufacturer could invalidate the approval of the appliance, operation of the warranty and could affect your statutory rights.

### **Health and Safety Notice**

#### **Important**

This appliance could contain some of the materials, indicated below, that could be interpreted as being injurious to health and safety. It is the users / installers responsibility to ensure that the necessary personal protective clothing is worn when handling these materials, see below for information.

**Artificial Fuels, Mineral Wool, Insulation Material, Refractory/Ceramic Fibres, Glass Yarn** - may be harmful if inhaled, may be irritating to skin, eyes, nose and throat.

**When handling** avoid inhaling and contact with skin or eyes. Use disposable gloves, facemasks and eye protection. After handling wash hands and other exposed parts. If a vacuum is used for cleaning the fuel bed or cleaning after servicing / installation it is recommended that it be of the type fitted with a HEPA filter.

**Disposal of refractory/ceramic materials.** To keep dust to a minimum these materials should be securely wrapped in polythene and be clearly labelled 'RCF waste'. These materials are not classified as 'hazardous waste and should be disposed of at a site licensed for the disposal of industrial waste.

## **INTRODUCTION**

The PARAGON 2000 Plus SLIDE CONTROL is a decorative fuel effect appliance with a radiant heat conserver box for improved efficiency.

The PARAGON 2000 Plus SLIDE CONTROL is designed and tested to the requirements of the EN 509

The PARAGON 2000 Plus SLIDE CONTROL is available in two versions **Natural Gas or LPG (Propane Gas Only)**. The markings (**G20** for natural gas or **G31** for propane) on the packaging and the data badge specify the gas for which the appliance has been factory set. **Note: These appliances should only be used on the appropriate gas specified. They are not suitable for conversion from one gas to the other.**

The PARAGON 2000 Plus SLIDE CONTROL should be installed and serviced by a competent person i.e. Gas Safe-registered, in accordance with the current Gas Safety (Installation and Use) Regulations 1998 (as amended).

The chimney or flue (unless new) must be swept before installation if it has been used for solid fuel or oil.

The PARAGON 2000 Plus SLIDE CONTROL incorporates a single gas control, which selects ignition pilot, and main burner low and high settings.

The PARAGON 2000 Plus SLIDE CONTROL incorporates a safety device in the form of an Oxygen Depletion System, which constantly monitors the oxygen in the room and will cause the fire to switch off if the oxygen level reduces, for instance due to insufficient ventilation or a blocked flue.

If this repeatedly occurs do not attempt to relight the appliance until a qualified engineer has checked it, the problem may not be due to lack of air or a defective flue.

**Warning:-**This appliance has a naked flame, has with all such fires it is recommended that a fireguard should be used for the protection of children, the elderly and infirm. Fireguards should conform to BS 6539 (1984) (Fireguards for use with solid fuel appliances).

During the normal operation of the fire some black staining may appear on some parts of the fuel bed. This is quite normal and adds to the appearance of the appliance. However, if excessive black staining does occur it may be due to the fuel bed being incorrectly laid. This should be checked prior to contacting a service engineer.

## SECTION TWO Operation (user instructions)

The full lighting procedure is as follows: -

- A. Push slide control lever down, as far as possible a clicking noise will be heard and the pilot will light, HOLD DOWN FIRMLY FOR ABOUT 20 SECONDS.
- B. Pull lever up and the pilot light should remain alight and the main burner should light on its low setting.
- C. Should the pilot fail to light, pull the lever fully up to turn off the appliance, wait 3 minutes and repeat the procedure (a & b). If the pilot does not light and no clicking noise is heard replace the battery and try again.
- D. After lighting the pilot flame and the main burner on its low setting the control lever may be lifted until slight resistance is felt, this will put the burner on its high setting.
- E. To completely extinguish the fire, pull the lever up past the resistance to its fullest extent.
- F. The fire may be operated on either its low or high setting.
- G. It is recommended that the appliance is operated on its high setting for a short period before adjusting to the low setting.
- H. If the ignition does not operate fit a new 9V battery (PP3/MN1602) to the ignition unit, located behind the fret adjacent to the gas inlet pipe, and repeat ignition procedure prior to reporting a fault.

**Note: -** If the ignition fails the pilot can be lit with a taper or a match held at the pilot head.

## SECTION THREE Fuel Bed Cleaning and Layout (user instructions)

**Important:** - Refer to the Health & Safety Notice located on page 5 of this booklet before cleaning or replacing any refractory material.

The fuel bed components are delicate and they should be handled with great care.

The loose parts and moulded shapes may be removed for cleaning. They can be brushed very gently with a soft brush to remove dust or any deposits.

A vacuum cleaner may only be used after the loose components and moulded shapes have been removed.

CARE SHOULD BE TAKEN TO AVOID CONTACT WITH THE REFRACTORY LINING THIS IS A DELICATE SURFACE AND SHOULD **NOT** BE WIPED OR RUBBED.

### FUEL BED LAYOUT (COAL OPTION)

- Ensure the BASE MATRIX is in position as shown located against the rear edge of the burner outlet

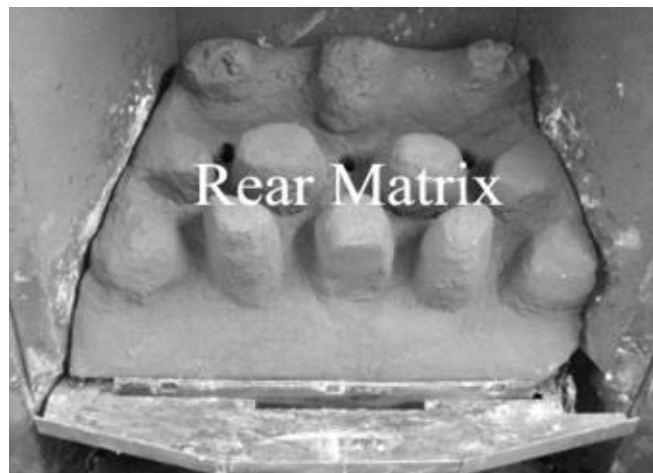

- Locate the LEFT HAND and RIGHT HAND FRONT COALS as shown so that they sit on the front rail and lean back against the BASE MATRIX. Note it is most important that they are located in their correct positions. They are marked on the rear "L" for LEFT HAND FRONT COAL and "R" for RIGHT HAND FRONT COAL.

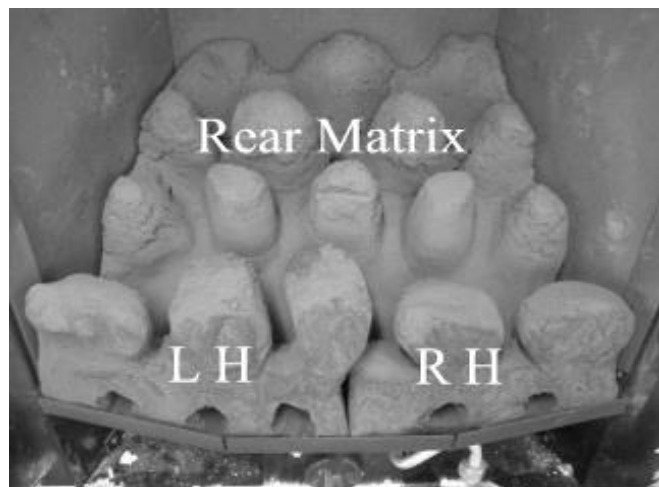

are

Slide front support over the front edge of fire where the left & front coals meet, see below

Note the loose coal provided consist of :-

5 off shaped as coal "A"

9 off shaped as coal "B"

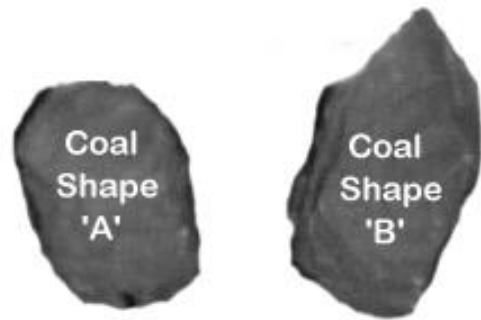

**NOTE :- 1x "A" shape to be omitted on Low Lintel versions.**

Separate the coal into the two size groups

- Lay first row of loose coals 4 off "B" coals and 2 off "A" coals as shown so they bridge across.



- Lay second row of loose coals 3 off "B" and 2 off "A" shapes as shown.





**P2000 Plus Version Only**

- Lay third row of loose coals 2 off "B" shape and 1 off "A" shape as shown for standard P2000 plus and P2000 plus extra.
- **FOR LOW LINTEL VERSIONS SEE BELOW**



**\*\* PLEASE NOTE \*\***

**Low Lintel Version Only**

- IMPORTANT INFORMATION!
- Do not lay the middle "A" Shape on Low Lintel version. This shape must not be fitted on the fuel bed layout.
- Only lay the two outer "B" shapes as shown.



**FUEL BED LAYOUT (PEBBLE OPTION) not available on Low Lintel.**

**Fuel Bed Components**

- Base Matrix
- L & R Front Pebbles
- Numbered Pebbles :-

| Pebble identification | QTY         |
|-----------------------|-------------|
|                       | Heart Shape |
| Oblong Shape          | 4           |
| Large Shape           | 3           |
| Medium shape          | 2           |
| Small shape           | 2           |
| Total                 | 12          |

**PEBBLE LAYOUT**

**Warning**

Take great care when positioning the pebbles to marking the black linings.

- Ensure the BASE MATRIX is in position as shown against the rear edge of the burner outlet.
- Locate the LEFT HAND and RIGHT HAND FRONT PEBBLES as shown so that they sit on the front rail and lean back against the BASE MATRIX. Note it is most important that they are located in their correct positions. They are marked on the rear "L" for LEFT HAND FRONT PEBBLE and "R" for RIGHT HAND FRONT PEBBLE.

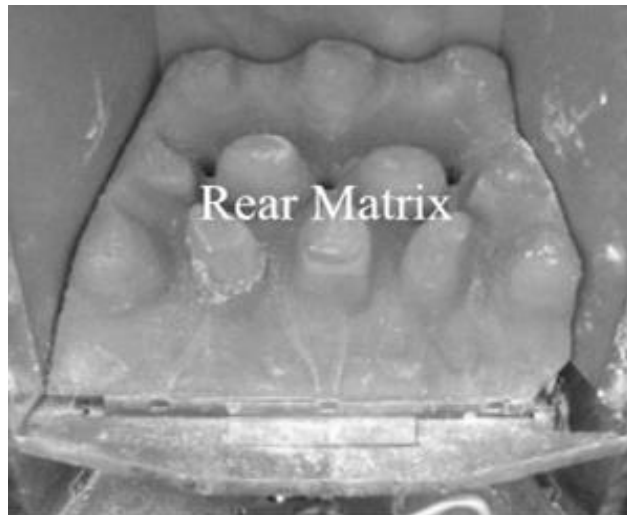

avoid

located

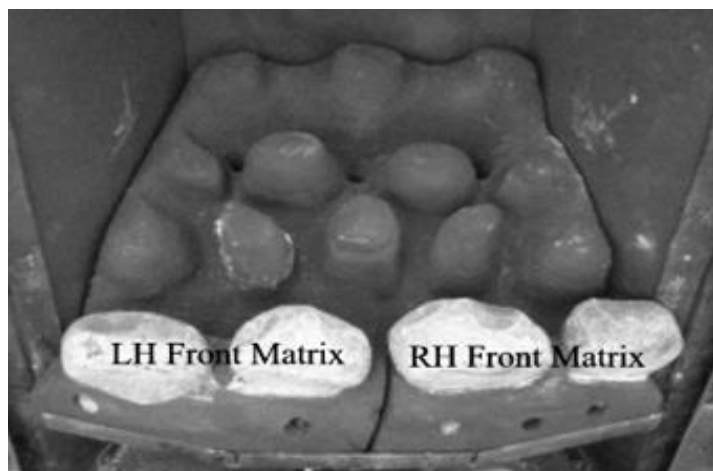

- Lay one row of pebbles at the front of the fire as shown.

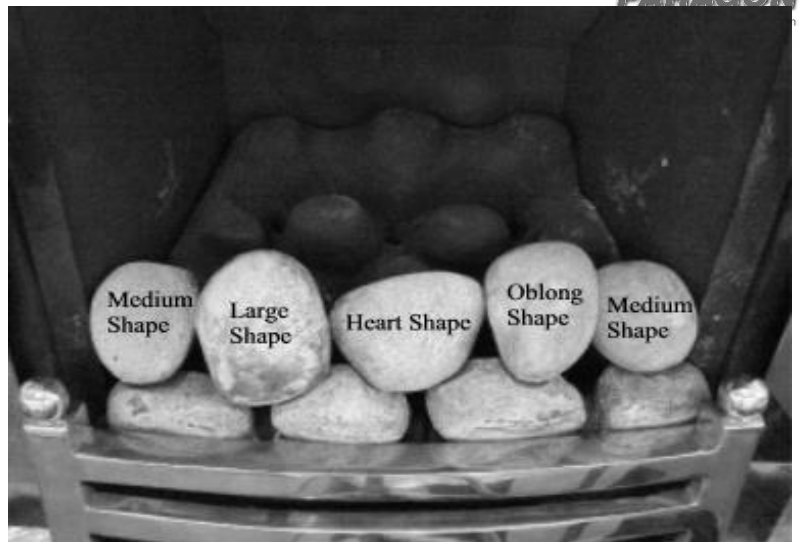

- Lay another row of loose pebbles shown.



- Lay another row of loose pebbles as shown.



## SECTION FOUR Important Information (user instructions)

The only user removable parts are: -

- The loose pebbles, coals .
- The left hand front pebble, coal shape.
- The right hand front pebble, coal shape.
- The base matrix
- Cast Fret
- Decorative Trim

Like all appliances incorporating an aerated burner a low frequency noise may be heard, particularly on the low setting, this is quite normal and does not affect the operation of the appliance.

### **Servicing**

It is advised that the PARAGON 2000 Plus SLIDE CONTROL fire is serviced annually this is more likely to provide trouble-free operation. A competent person must carry this out, i.e. Gas Safe Registered Installer in accordance with the current Gas Safety (Installation and Use) Regulations 1998 (as amended).

The chimney or flue should be checked annually to ensure clearance of combustion products.

### **Ventilation in the United Kingdom**

This appliance does not normally require purpose-built ventilation but if for any special reason purpose-built ventilation is provided it should be checked periodically to ensure freedom from obstruction.

### **Ventilation in the Republic of Ireland**

Must be permanent ventilation and must comply with the rules in force and should be checked periodically to ensure freedom from obstruction.

### **General Appliance Care**

Any debris from the chimney or flue should be removed from the fuel bed. The fire should be allowed to cool for three to four hours before removing debris.

Rubbish must not be thrown onto the fuel bed under any circumstances. The cast fire front must be positioned in front of the fire whilst it is burning.

## **Fret (Fire Front)**

A Fret must be used with this appliance, and must conform too: -

- It must be made from non-combustible material.
- Its general construction should enable it to stand firmly across the full width of the burner.
- The design of the fire front (fret) must have a removable ashtray cover (lower section).
- The ash tray cover must have cut-outs and or holes which provide ventilation to the underside of the burner.
- The effective area of ventilation through the ash tray cover must be greater than 1365mm<sup>2</sup> (2.12 sq. ins.)

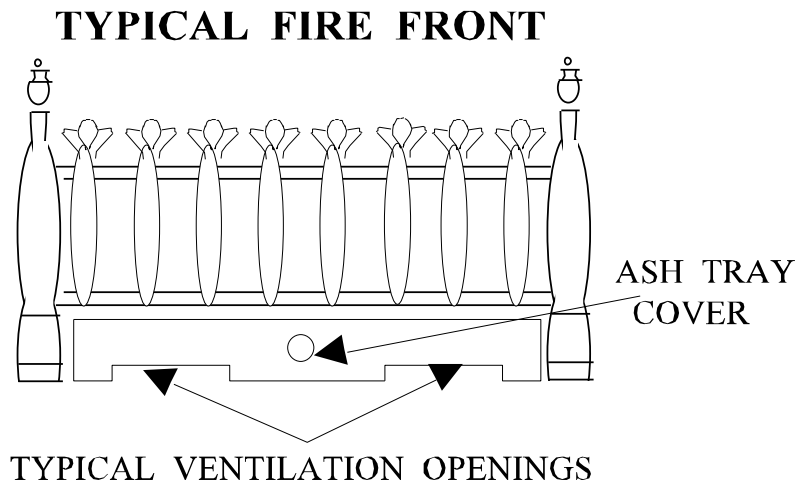

## SECTION FIVE Specification (installation instructions)

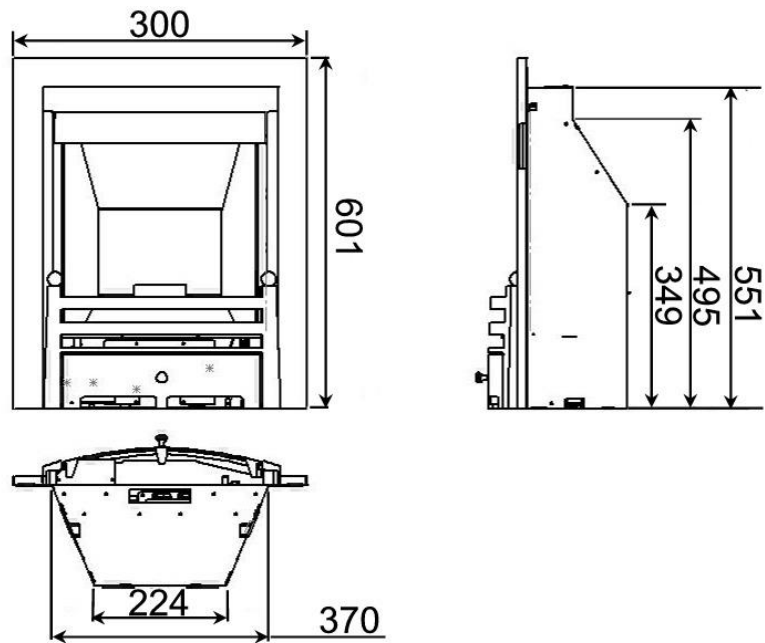

**NOTE! Low Lintel version fire box height is 497mm (551mm standard P2000+)**

|                             | NATURAL GAS   | PROPANE GAS     |
|-----------------------------|---|-----------------|
| Category of Appliance:..... | B <sub>AS</sub>   | B <sub>AS</sub> |
| Category                    | I <sub>2H</sub>   | I <sub>3P</sub> |
| Gas type:.....              | G20   | G31             |
| Gas Pressure:.....          | 20 mbar   | 37 mbar         |
| Gas input high:.....        | 7.00 kW Gross   | 7.00 kW Gross   |
| Gas input low:.....         | 2.40 kW Gross   | 2.40 kW Gross   |
| Injector Main:.....         | Size 460  | Size 135        |
| Data Label Location:..      | Frame of appliance on top RH corner behind trim (2000 Plus) |                 |
|                             | Lower L/H Flange of Appliance (2000 Plus Lo Lintel)         |                 |
| Gas Connection:.....        | 8 mm OD Tube  |                 |

NOTE: The efficiency of this appliance has been measured as specified in BS7977-1 2009 and the result is 55.6% The gross calorific value of the fuel has been used for this efficiency calculation. GASTEC have certified the test data from which it has been calculated. The efficiency value may be used in the UK Government's Standard Assessment Procedure (SAP) for energy rating of dwellings.

## SECTION SIX Regulations and Warnings

- THIS APPLIANCE MUST ONLY BE INSTALLED IN THE GB OR IRELAND.
- Only to be used in sufficiently ventilated room. Read instructions carefully before installation and use. The appliance must be installed by a competent person, i.e. Gas Safe Registered Installer in accordance with the current Gas Safety (Installation and Use) Regulations 1998 (as amended). Failure to do so could lead to prosecution.
- This PARAGON 2000 Plus SLIDE CONTROL is for use ONLY with the GAS STATED ON THE DATA BADGE this may be *G20 for Natural Gas or G31 for Propane Gas.*

### **CHECK YOU HAVE THE CORRECT APPLIANCE FOR THE GAS YOU ARE USING.**

- It can be used in conjunction with the following chimneys: -
- A conventional brick or stone chimney,
- A pre-cast flue conforming to BS 1289 Pt. 1 or Pt. 2
- A metal flue and box conforming to BS 715, further details are covered in later text.
- A non-combustible hearth must be provided to comply with the building regulations or a suitable proprietary fire surround with a 100 degrees C rating.
- During initial firing an odour may be evident. This is the binder used during the manufacture of the fibre components and there are no harmful effects produced.

The following are the relevant Codes of Practice and British Standards: -

BS 5871      BS 8303 1986      BS 5440 part 1      BS 6461 parts 1 & 2 1984

BS 6891      BS 715 1989      BS 1251 1987      BS 1289 part 1& 2 1986/1990

**Note:- This appliance must be installed to current versions of the above standards and include any relevant amendments.**

The Building Regulations issued by the Department of the Environment

The Building Standards (Scotland) (Consolidation) Regulations issued by the Scottish Development Office.

## SECTION SEVEN Siting the Appliance (installation instructions)

The fire can be installed in the following flues and locations: -

### **CLASS ONE**

A conventional brick or stone chimney as used for a solid fuel appliance with a typical effective cross-sectional dimension of 225 x 225 mm (9 x 9 ins) or a lined flue with a minimum diameter of 125 mm (5 ins)

**Note: The restrictor plate, which is separately packed, may be fitted to flue of 175mm (7") or greater. This being subject to satisfactory product clearance.**

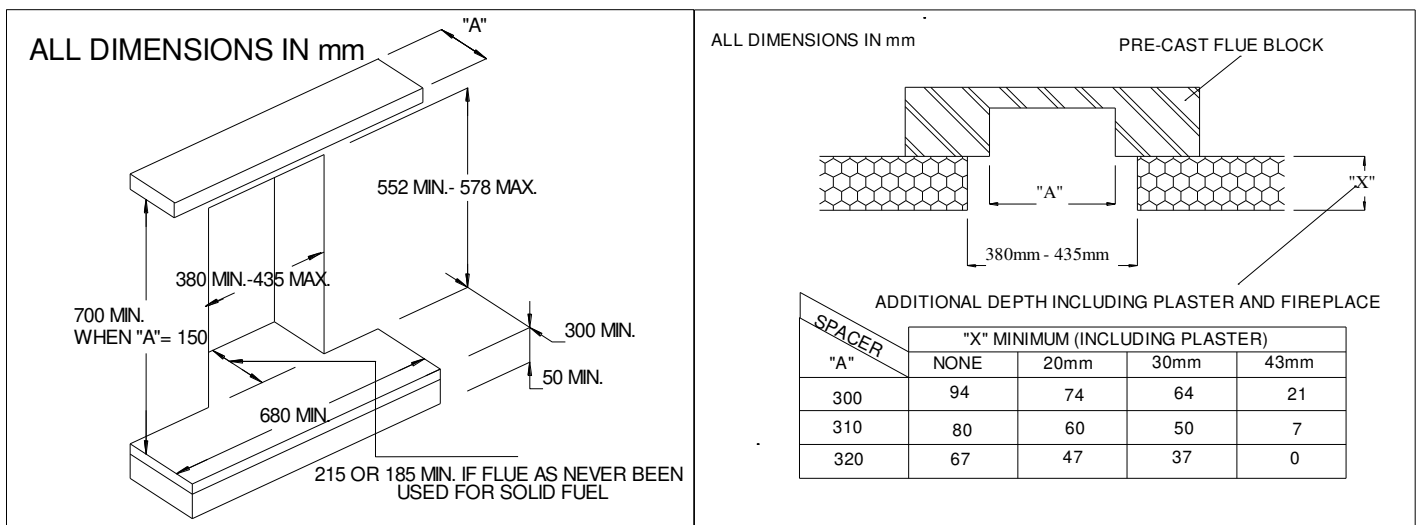

**NOTE :- LOW LINTEL OPENING HEIGHT IS REDUCED TO 500mm – 526mm.**

**P2000 PLUS & P2000 PLUS EXTRA :-** Fireplace opening must be 552 mm - 578 mm high by 380 mm – 435 mm wide (or up to 458 mm if the cable fixing system is used).

**P2000 PLUS LOW LINTEL :-** Low Lintel fireplace opening must be 500 mm – 526 mm high by 380 mm – 435 mm wide (or up to 458 mm if cable fixing system used).

The opening depth must be a minimum of 215 mm to allow sufficient volume for debris collection (this depth may be reduced to 185 mm if the chimney is new or has never been used for solid fuel or oil before).

To obtain this depth it may be necessary to remove the chairbrick.

**Note: spacers are available in 20mm and 43mm to further reduce the opening depth if required (if a spacer is used then the thickness of the spacer must be added to the minimum 300mm hearth depth to comply with regulations.**

Any permanent flue restriction or variable dampers are to be removed or locked fully open.

The chimney should be swept prior to installation if not new.



## CLASS TWO PRE-CAST

A pre-cast flue conforming to the requirements of BS 1289 part 1 & 2. A suitable fire resisting fire surround will be required, spaced out to the correct thickness, between the face of the flue blocks and the rear of the appliance frame.

**IMPORTANT: - the flue restrictor plate must not be fitted when the appliance is installed in this type of flue.**

**Note:** An inspection should be made to ensure that the internal walls of the flue are clear of mortar fangs. It is recommended that the plasterwork should not be directly bonded to the surface of the flue blocks, ensuring that there is a small air gap between the flue blocks and the wall surface. The fire can be installed with the plasterwork being directly bonded to the flue blocks but there is a risk of surface cracking occurring to the plaster above the appliance.

The restrictor plate must be broken off if the appliance is fitted to a 125mm or precast flues or where spillage is detected on commissioning

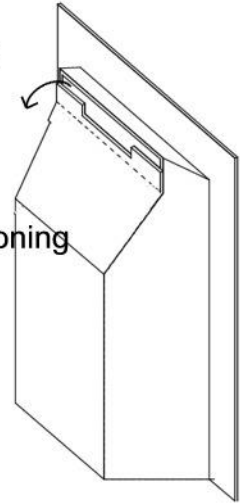

## CLASS TWO FABRICATED METAL

A double-walled or insulated metal flue box built to the requirements of BS 715 with an insulated flue having a minimum diameter of 125 mm (5 ins) and a minimum effective overall height of 3 metres (10 ft).

**IMPORTANT: - the flue restrictor plate must not be fitted when the appliance is installed in this type of flue.**

**Note:** A brick or stone chimney with a 125 mm (5 ins) minimum diameter flue liner conforming to BS 715 may be used. Provided a suitable sealing plate is fitted to the base of the liner and the appliance does not restrict the opening into the liner.

**Note:** Dampers or register plates must not restrict any of the above flues. The flue must only service a single appliance and not have any branches or traps, which may impede the natural draught. If a terminal is fitted it must be suitable for the purpose.

## SECTION EIGHT Fireplace Requirements (installation instructions)

A flat face of 605 mm high x 500 mm wide must be provided around the fireplace opening for the fixing of the appliance to ensure that a good seal is formed. The base of the fire opening must be flat to ensure sound fixing of the appliance.

A non-combustible hearth must be provided beneath the appliance within the fireplace opening, a fire-resisting hearth must also be provided symmetrically disposed about the fireplace opening a minimum thickness of 12 mm with the perimeter 50mm above floor level. The width must extend a minimum of 150 mm either side of the fireplace opening and a depth of 300 mm (+ thickness of spacer if a spacer is used).

Purpose-built superimposed fire-resistant hearths and back panels, specified as suitable by the manufacturers, may be used, or a suitable proprietary fire surround with a 100°C rating.

### Hole in the Wall Installation

#### Please read these instructions carefully if you intend an Installation without a hearth.

*This appliance must be installed in accordance with all relevant sections of approved document "J" of the building regulations*

It is recommended that a non combustible hearth extends a minimum of 300mm forward of the fire opening and a minimum of 150mm either side, and that a rise exist at the front edge and sides of the hearth of a minimum of 50mm.

The fire may be installed so that its base sits on a surface of a fire opening at least 105 mm up from the floor (*this is to ensure that no flame or incandescent material is less than 225mm above the floor, a requirement of approved document "J"*). Where this is the case a means must be provided to support the fret this may typically be met with a small projecting hearth of minimum 100mm. Unless the fret is fixed to the appliance or is an integral part of the fascia of the appliance.

Consideration should be given to the location of the appliance ensuring it is very visible and it should be positioned at a height where it can clearly be seen on approach.

Frets, and Fascias used for HOLE in the WALL must be compliant with Paragon Fires CE approval; these are listed at the end of this page.

Where the fire is fitted as a "Hole in the Wall" without a hearth the installer MUST ensure the appliance is fixed firmly into the opening to ensure no movement takes place to the fuel bed when the appliance controls are operated.

The installer MUST ensure that the fuel bed is laid correctly and securely

The installer MUST advise the user that care should be taken when the appliance is in use to ensure occupants **do not** get unnecessarily close to the appliance or position furniture or other appliances to close.

The installer MUST remind user of the requirement to fit a "secure fireguard" where the room is used by elderly, infirm or young persons.

The installer MUST explain to the user that the area immediately in front of the appliance must always be kept clear of combustible items other than the floor covering (which must be fixed)

Purpose-built superimposed fire-resistant hearths and back panels, specified as suitable by the manufacturers, may be used, or a suitable proprietary fire surround with a 100°C rating.

### **CLEARANCE TO SHELF**

Minimum clearance from hearth to underside of combustible shelf should be 700mm provided shelf depth 150mm or less. This height may be reduced to 640mm for a shelf depth of 100mm or less. ( Low Lintel 650mm for shelf of 150mm).

When the shelf depth is increased by increments of 12.5 mm greater than 150mm, add 25mm to the 700mm minimum clearance.

### **CLEARANCE TO SIDES OF FIRE**

Minimum width between vertical sides of combustible surround should not be less than 700mm provided fire is central to surround and sides do not project more than 150 mm. When vertical side forward projection is increased by 12.5 mm add 50 mm to inside width of surround.

N.B. When fire is fitted this provides a minimum side clearance of 100mm.

Care should be taken to prevent any damage being caused to surrounding soft furnishings or decoration, e.g. many embossed vinyl wall coverings may become discoloured if placed too close to the appliance.

### **VENTILATION**

In the **United Kingdom** no special ventilation bricks or vents are required into the room containing the appliance, provided normal adventitious room ventilation exists. The installer must satisfy this point by carrying out a mandatory spillage test.

In the **Republic of Ireland** permanent ventilation must comply with the rules in force

## **[SECTION NINE To Install the Appliance \(installation instructions\)](#)**

### **EXAMINE FLUE / CHIMNEY**

Check that the flue/chimney conforms to the required specifications as previously stated. Examine the condition and carry out any remedial work. If the flue/chimney has been used for solid fuel or oil, it should be swept prior to appliance installation. A smoke test must be carried out to check that satisfactory smoke clearance has been established. If all the smoke is not drawn into the flue, pre-heat the flue with a blowtorch or similar and re-check. If there is any uncertainty examine for the cause and, if necessary, seek expert advice.

### **CONNECTING THE GAS SUPPLY**

Determine where the gas supply is to be connected to the appliance. This may be done from the front of the unit from either the left or right side, or a concealed fitting from the rear.

## **PREPARING THE APPLIANCE FOR A GAS CONNECTION**

If it is intended to be a concealed connection the 8mm supply should be positioned in the opening first.

The pipe should be positioned so that when the appliance is pushed back into the opening it enters the grommet hole at least 180mm, taking into account the requirements of BS 6891 1988 dealing with enclosed pipes.

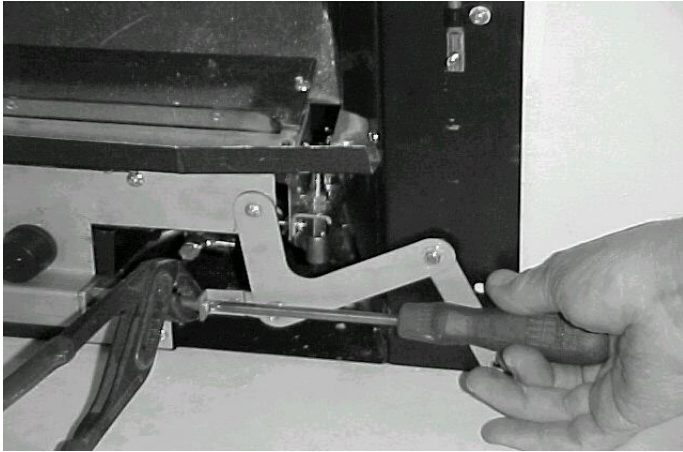

Taking great care grip the copper protective sleeve at the end of the gas control spindle (DO NOT GRIP SPINDLE IN ANY OTHER PLACE) as shown and remove the screw from the end as shown above.

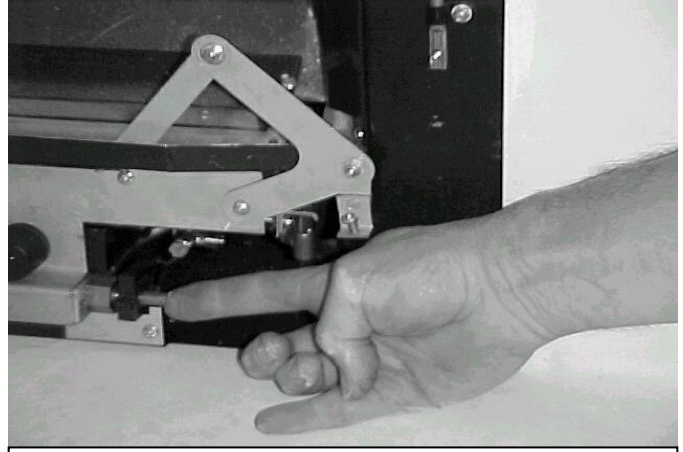

Ensure the spindle is pushed back inside the control valve as far as possible. Ensure the bell crank mechanism is swung up to give easy access to the gas connection point as shown.

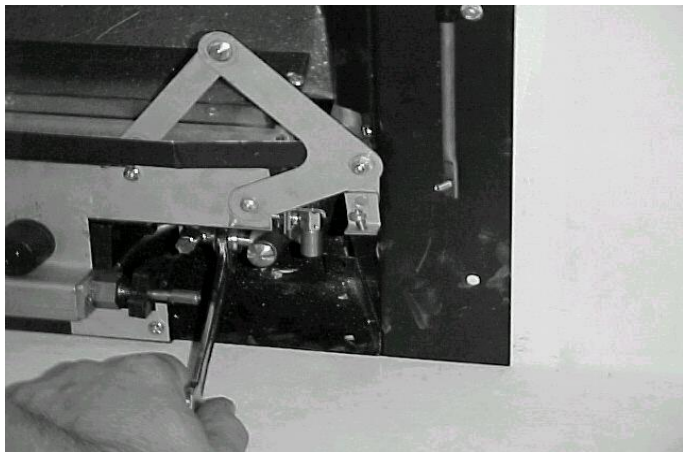

Cut a cross slit in the rubber grommet and feed the appliance onto the 8mm-gas supply pipe. Position the restrictor elbow supplied and mark supply pipe at its cut off length. Remove appliance, cut pipe to correct length, refit appliance and make gas connection with restrictor elbow use 15mm A/F spanner taking care not to apply any force to the gas control spindle as above. Ensure the restrictor valve is opened and its cap replaced tightly.

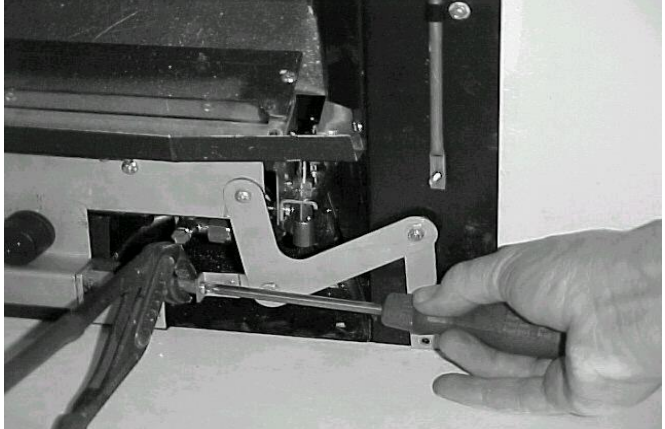

Check for gas soundness. Reconnect the bell crank mechanism as above ensuring that the gas control spindle is gripped only over the protective copper sleeve and no other part of the spindle as, ensure NO side strain is applied to the spindle.

Note: pipe-work in the opening of the fireplace to the rear of the appliance must be suitably wrapped in accordance with the regulations.

## GAS CONNECTION FROM THE FRONT

Connections may be made from the front of the appliance from either the left or right in 8-mm diameter pipe. If a left-hand connection is required the tube should be routed below the gas control and onto the inlet elbow. The inlet elbows should be rotated to the required position. A suitable isolating cock should always be fitted in the supply feed to the fire to facilitate servicing.

## FIXING FIRE INTO OPENING

Remove the paper backing from the length of foam seal and stick it around the rear flange of fire. If a spacer is going to be used stick the second length (supplied with the spacer kit) around the rear face of the spacer unit, THE FOAM SEAL MUST BE POSITIONED TO ENSURE AN AIR TIGHT SEAL WHEN THE APPLIANCE IS FITTED.

**NOTE:** -DO NOT USE PERMANENT SEALING COMPOUNDS i.e. **SILICON SEALANT**. THIS COULD CAUSE THE APPLIANCE TO BE DAMAGED WHEN IT IS REMOVED FOR SERVICING, AND COULD INVALIDATE THE WARRANTY.

If the spacer is not being used, mark position of flange hole in the fireplace front drill and fix firebox in position with wall plugs and wood screws. If spacer is being used fix the spacer to the fireplace first with wood screws and wall plugs then screw firebox to spacer box using screws provided.

## OPTIONAL CABLE FIXING SYSTEM (Available on request from PARAGON FIRES)

(for use when fixing to 18" openings or when it is desirable not to drill the fireplace fascia) it may **not** be possible to use the cable fixing system with some pre-cast flues.

Drill 4 holes in the rear of the fireplace opening in the position shown and fix securely the 4 eye bolt provided with suitable wall plugs

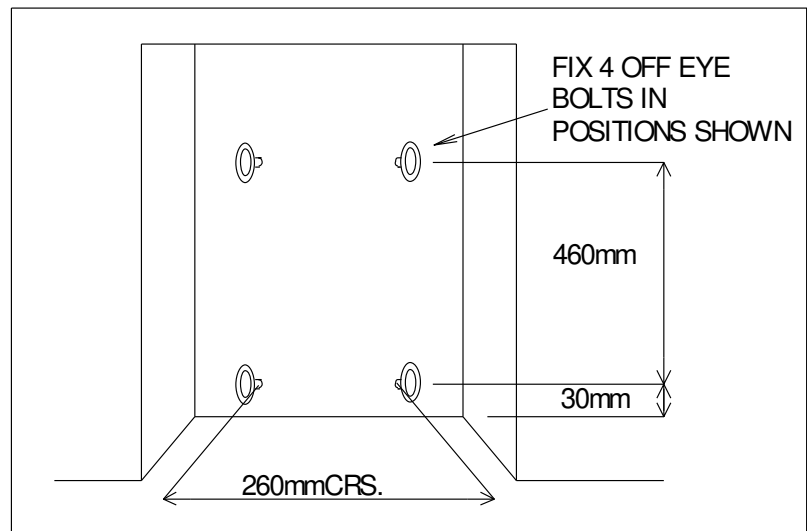

## NOTE LOW LINTEL VERSION

The 460mm measurement up from the bottom eye's can be reduced to 410mm on the Low Lintel Version.

Fix the fire casing back into the opening using the cable fixing system as shown in do not cut off loose ends of cable after fixing, coil and tuck carefully back

Note: when using the cable fixing kit with the spacer, fix and seal the spacer to the rear of the appliance flange with the screws and foam seal provided.

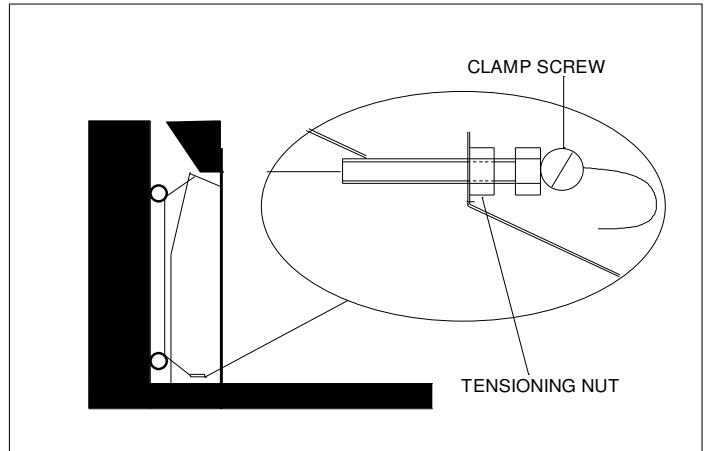

## CHECKING GAS SOUNDNESS

After completing the gas connection to the appliance, check for gas soundness in accordance with current codes of practice.

## CONNECTING CONTROL LEVER



Flip the slide control lever round so that the rubber-capped end is protruding out to the right as shown in the left-hand picture. Check that it slides freely up and down in the nylon slide guides. Remove the nylock nut with a 7mm A/F spanner as shown.

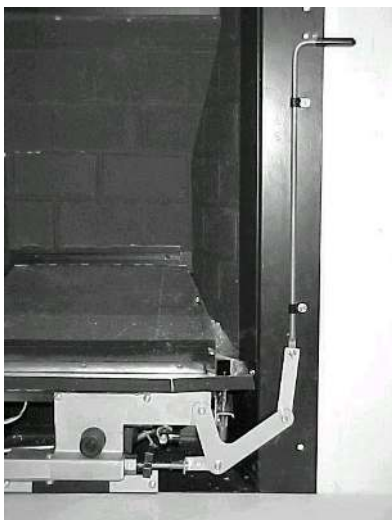
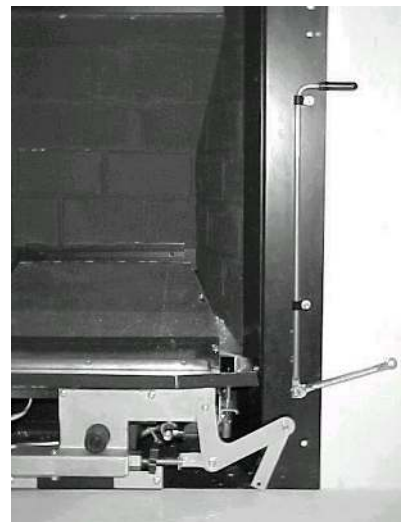

Connect the link lever to the stud at the end of the slide control lever and replace the nylock nut. **IMPORTANT TURN THE NUT UNTIL IT JUST TIGHTENS AND THEN TURN IT BACK A HALF TURN.** Check the operation on the lever and mechanism ensure that the lever springs back to the low position when it is released after pushing down.

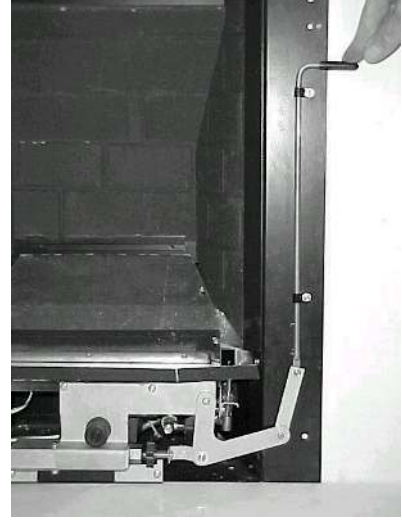

## **FUEL BED LAYOUT**

**Important: - Refer to the Health & Safety Notice located on page 5 of this booklet before cleaning or replacing any refractory material.**

Lay fuel bed as shown in the Section 3 of these instructions.

ENSURE THE FUEL BED IS PLACED AS INDICATED IN THESE INSTRUCTIONS.

## **CHECKING OPERATION OF FIRE**

Remove the screw from the pressure test point on the inlet elbow and fit pressure gauge. Turn on gas to the appliance. Purge the air from the appliance by holding the control lever down to allow the air in the pipe-work to be purged and the spark generator to ignite the pilot. Check that the electrode is sparking at the gap between the thermocouple tip and the electrode, continue until pilot ignition is established. Raise the control lever to its high position and allow the appliance to run for a period of approximately 5 minutes. Check the inlet pressure is  $20 \pm 1$  mbar for Natural Gas (G20) or  $37 \pm 1$  mbar for Propane Gas (G31).

## **CHECKING PRODUCT CLEARANCE**

Check for satisfactory clearance of combustion products. Close all doors and windows and leave fire burning for 5 minutes. Then position a smoke match just into the top of the fire opening and move it left and right, all the smoke must be drawn into the flue. If spillage occurs, allow a further 5 minutes. Should spillage still occur, remove appliance restrictor plate if still fitted and repeat spillage test. If spillage still occurs turn off the fire and seek expert advice.

If an extractor fan is situated in the room this test should be repeated with the fan running. If there is a connected room with an extractor fan, the test should be repeated with all the doors to that room opened and the extractor fan running.

## **COMPLETION OF INSTALLATION**

Fit the decorative trim with the four magnetic strips placed two on each vertical side flange of the firebox - one at the top and one at the bottom. Offer the decorative trim up squarely and centrally and push back into position. Ensure the positioning of the magnet does not interfere with the operation of the slide control mechanism.

Position a suitable fire fret up to the front of the appliance ensuring that it meets the specification referred to earlier.

Demonstrate the lighting and extinguishing procedures to the user and the removal and refitting of the decorative trim and fret for cleaning.

### **ADVISE CUSTOMER THAT:**

- This appliance has a naked flame, as with all such fires it is recommended that a fireguard should be used for the protection of children, the elderly and infirm. Fireguards should conform to BS 6539 (1984) (Fireguards for use with solid fuel appliances).
- The curing effect of heating the fuel bed and other Refractory components will cause an initial odour. This is due to the starch used in the manufacturing process and is non-toxic.
- Any debris should be cleaned from the appliance. A vacuum cleaner can be used but only after all the loose components have been removed. The appliance should be serviced annually by a competent person in accordance with these instructions and the appliance checked for spillage in accordance with the method detailed in these instructions.

**Hand these instructions over to the user.**

## **SECTION TEN Maintenance Instructions (maintenance instructions)**

### **GENERAL**

Servicing should be carried out annually by a competent person such as a Gas Safe registered person in accordance with the current Gas Safety (Installation and Use) Regulations 1998 (as amended), this should ensure the safe and correct operation of the appliance.

Before commencing any service or replacement of parts, turn off the gas supply to the fire. After servicing check for gas soundness.

When ordering spare parts please quote appliance name and serial number, these can be found on the data badge, which is located by removing the decorative fire trim.

At least once a year, check for debris in the catchment area behind the fire and in the flue way.

If soot has accumulated check, to establish cause, rectify and clean flue or chimney accordingly.

### **FUEL BED CLEANING**

**Important: - Refer to the Health & Safety Notice located on page 5 of this booklet before cleaning or replacing any refractory material.**

The fuel bed components are delicate and they should be handled with great care.

The loose parts and moulded shapes may be removed for cleaning. They can be brushed very gently with a soft brush to remove dust or any deposits. A vacuum cleaner may only be used after the loose components have been removed.

Examine the fuel bed components for signs of cracking and replace if necessary. (IMPORTANT) see fuel bed layout procedure before attempting to replace loose fuel bed components, which should only be replaced as a complete set with no extra components.



## PILOT LINTING

Check pilot aeration holes for linting, use a vacuum cleaner nozzle taking care not to damage the pilot head. (This should be done every time the fire is serviced)

## REPLACEMENT OF GAS CONTROL AND OR THE SPARK GENERATOR

1. Turn off the gas supply by isolating cock.
2. Lift away carefully fire fret.
3. Lift away carefully all loose fuel bed components.
4. Lift away carefully both Left-hand and right-hand front matrix.
5. Lift away carefully rear matrix.
6. Disconnect gas supply from inlet elbow of appliance (right of gas control)
7. Undo and remove two lower screws from fixing plate at front of appliance.
8. Undo and remove two screws securing the main coal support.
9. Undo the nut at the lower end of the slide control lever and separate it from the link
10. Lift away the appliance engine from the main casing.
11. Remove the ignition lead carefully from the pilot and the two switch leads from the gas valve ignition switch on the spindle of the gas control.
12. Remove the spark generator by removing the battery cap, battery and remove the generator by loosening its bezel nut.
13. Disconnect the three compression gas connections from the gas control.
14. Undo the thermocouple connection from the rear of the gas control tap.
15. Undo the screw in the centre of the gas control spindle and remove from linkage.
16. Undo and remove the two screws securing the gas control tap to assembly.
17. Service or replace gas control tap as necessary.
18. Re-assemble in the reverse order. **(Ensure when fitting spark generator that fixing nut is tight to ensure a suitable earth to the firebox)**
19. Turn on the gas supply, check for soundness and recommission appliance.

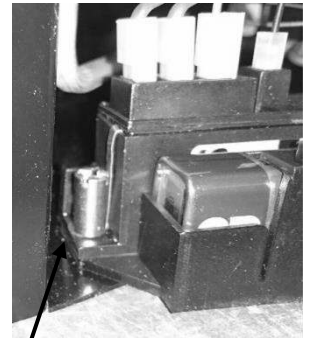

Ensure this nut is tight for a good earth connection

## REPLACEMENT OF BURNER AND OR THE SILENCER

**NOTE:** The silencer must not be modified and must be correctly positioned in its bracket.

1. Repeat operations 1-5 for the removal of the gas control and spark generator.
2. Undo the two screws securing the burner in the top of the main coal support and remove burner and silencer.
3. Clean, service or replace as necessary.
4. Re-assemble in reverse order.
5. Turn on gas supply, check for gas soundness and recommission appliance.

## **REPLACEMENT OF INJECTOR**

1. Repeat operations 1-10 for removal of gas control and spark generator
2. Repeat operation 2 for removal of burner and or silencer.
3. Disconnect gas connection to injector and gas control.
4. Unscrew the locking nut fixing injector to mounting bracket.
5. Clean or replace as necessary.
6. Re-assemble in reverse order.
7. Turn on gas supply, check for gas soundness and recommission appliance.

## **REPLACEMENT OF OXY-PILOT ASSEMBLY**

**NOTE:** If the pilot assembly is replaced it must be replaced by an identical unit from the same manufacturer and replaced as a complete unit.

1. Repeat operations 1-10 for removal of gas control and spark generator.
2. Disconnect the thermocouple from the gas control tap.
3. Disconnect the gas connection from the pilot assembly.
4. Remove ignitor lead from pilot assembly.
5. Undo the two screws securing the oxy-pilot to the burner.
6. Re-assemble in the reverse order.
7. Turn on the gas supply, check for gas soundness and re-commission appliance.

## **Replacement of battery**

1. Remove fret from in front of the fire
2. Slide battery not of the spark generator
3. Pull battery connection terminal away from battery (careful not to damage the connection terminal on the lead)
4. Attach new battery to the terminal on the lead
5. Slide battery in to the spark generator ensuring its all the way in so it can't fall out and the hook is over the top of the battery
6. Replace the fret back in front of the fire

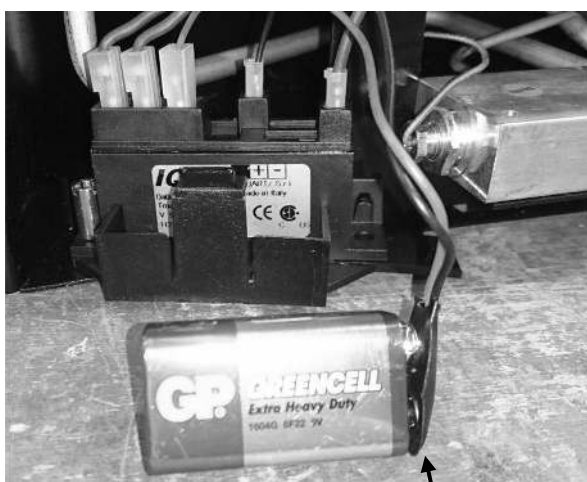

Careful when removing and attaching this connection not to damage the terminal

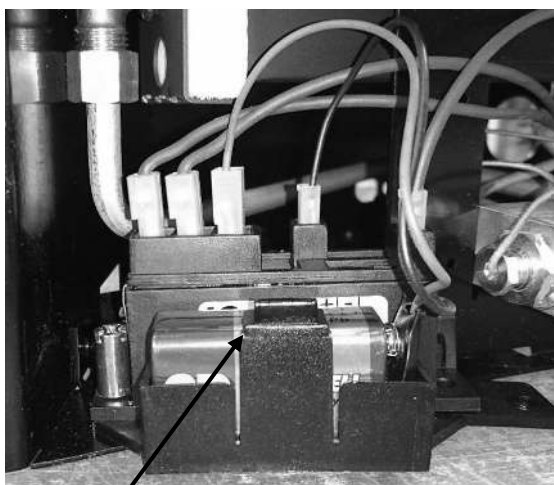

Ensure battery is located properly so this hook hold the battery in place





## Register your appliance online today to active your warranty



## GAS FIRE COMMISSIONING CHECKLIST

This Commissioning Checklist is to be completed in full by the competent person who commissioned the gas fire as a means of demonstrating compliance with the appropriate Building Regulations and then handed to the customer to keep for future reference.

Failure to install and commission according to the manufacturer's instructions and complete this Benchmark Commissioning Checklist will invalidate the warranty. This does not affect the customer's statutory rights.

| Site Requirements   | Yes                                 | N/A |
|---|-------------------------------------|-----|
| Was the chimney checked to ensure it only serves one flue/fire, has no obstructions and is continuous?  |                                     |     |
| Has any debris at the base of the chimney been removed?   |                                     |     |
| For brick chimney installations is there enough depth for 12 litres of debris, or precast flues 2 litres of debris? (see instructions for debris gap details) |                                     |     |
| Have damper and register plates been removed or locked in the fully open position ensuring correct size of flue is maintained?                                |                                     |     |
| If previously used for solid fuel has the chimney been thoroughly swept?  |                                     |     |
| If the chimney is pre-cast has the inside of the flue been checked for extruded cement / sealant which must be removed?                                       |                                     |     |
| Has the fire place been checked for under-floor air supply which must be sealed off?  |                                     |     |
| Has the chimney been inspected prior to fitting the gas fire to ensure that it is in good condition?  |                                     |     |
| Has the structure of the chimney been checked for leakage using a smoke pellet test? (See BS5440-1 for details).  |                                     |     |
| <b>Ventilation</b>  |                                     |     |
| Does the installation require any additional ventilation requirements as detailed in the manufacturer's instructions?   |                                     |     |
| <b>Hearth Requirements- where fitted</b>  |                                     |     |
| Is the hearth constructed from non -combustible material?   |                                     |     |
| Is the hearth a minimum of 12mm thick with a minimum floor to top surface of 50mm?(BS5871) or as per manufacturer's instructions?                             |                                     |     |
| Is the hearth for open fronted fires a minimum of 760mm wide and has 300mm projecting from the fire opening (BS6871) or to manufacturer's instructions?       |                                     |     |
| Mounting height (where applicable) has the fire been installed to the correct mounting height- as per manufacturer's instructions?                            |                                     |     |
| <b>Firebox and Fuel Bed</b>   |                                     |     |
| Has the fuel bed, coals, pebbles etc. been fitted to manufacturer's instructions?   |                                     |     |
| <b>Gas Supply</b>   |                                     |     |
| Has an isolation tap/restrictor inlet elbow been fitted for servicing?  |                                     |     |
| Has the gas supply been thoroughly purged prior to connection to remove any debris?   |                                     |     |
| Has a gas tightness test been completed prior to breaking into the gas supply and following completion of installation?(IGEM/UP/1B)                           |                                     |     |
| Record burner gas pressure reading? If only the supply pressure is available a gas rate must be undertaken.(GSIUR REG26/9C)                                   |                                     |     |
| Record dynamic inlet gas pressure (working pressure) reading (all gas appliances running)   |                                     |     |
| <b>Spillage test</b>  |                                     |     |
| Installation passes smoke match test with any extractor fans turned on (see manufacturer's instructions)  |                                     |     |
| <b>Installation</b>   |                                     |     |
| Has the gas fire been installed and commissioned in accordance with manufacturer's instructions?  |                                     |     |
| Has the fire been installed with the correct clearance to combustible materials, as per manufacturer's instructions?  |                                     |     |
| The operation of the appliance and controls have been demonstrated to the customer including battery replacement where applicable?                            |                                     |     |
| The manufacturer's literature, including Benchmark Checklist and Service record has been explained and left with the customer?                                |                                     |     |
| Has the appliance been registered with the Local Authority as detailed on the Gas Safe web site and is a legal requirement and forms part of the warranty?    |                                     |     |
| Customer's Signature:<br>(To confirm satisfactory demonstration and receipt of manufacturer's literature)   | Commissioning Engineer's Signature: |     |

\*All installations in England and Wales must be notified to be Local Authority Building Control (LABC) either directly or through a Competent Persons Scheme. A Building Regulations Compliance Certificate will then be issued to the customer.

# SERVICE RECORD



**It is essential that your gas fire is serviced regularly and that the appropriate Service Interval Record is completed. Service Provider**

Before completing the appropriate Service Record below, please ensure you have carried out the service as described in the manufacturer's instructions. Always use the manufacturer's specified spare part when replacing controls.



|                       |       |
|-----------------------|-------|
| <b>SERVICE 01</b>     | Date: |
| Engineer name:        |       |
| Company name:         |       |
| Telephone No:         |       |
| Gas safe register No: |       |
| Comments:             |       |
|                       |       |
|                       |       |
| Signature             |       |

|                       |       |
|-----------------------|-------|
| <b>SERVICE 02</b>     | Date: |
| Engineer name:        |       |
| Company name:         |       |
| Telephone No:         |       |
| Gas safe register No: |       |
| Comments:             |       |
|                       |       |
|                       |       |
| Signature             |       |

|                       |       |
|-----------------------|-------|
| <b>SERVICE 03</b>     | Date: |
| Engineer name:        |       |
| Company name:         |       |
| Telephone No:         |       |
| Gas safe register No: |       |
| Comments:             |       |
|                       |       |
|                       |       |
| Signature             |       |

|                       |       |
|-----------------------|-------|
| <b>SERVICE 04</b>     | Date: |
| Engineer name:        |       |
| Company name:         |       |
| Telephone No:         |       |
| Gas safe register No: |       |
| Comments:             |       |
|                       |       |
|                       |       |
| Signature             |       |

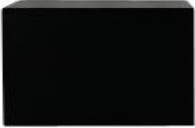
|                       |       |
|-----------------------|-------|
| <b>SERVICE 05</b>     | Date: |
| Engineer name:        |       |
| Company name:         |       |
| Telephone No:         |       |
| Gas safe register No: |       |
| Comments:             |       |
|                       |       |
|                       |       |
| Signature             |       |

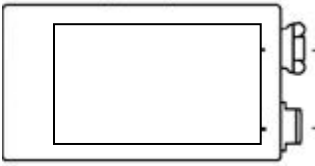
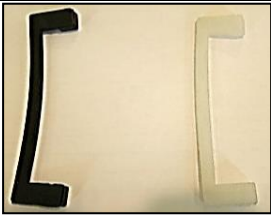
| Product   | A-0027 | A-0402 | Serial No | JG       | NN |
|---|--------|--------|-----------|----------|----|
| ID Label  | A-0029 |        | Prefix    | JH (LPG) |    |
| Burner Tray / Box Assembly  |        |        |           |          |    |
| Ceramics Set (Part no 5568)   |        |        |           |          |    |
| Fixing Kit (0705) eye bolt    foam strip    screw    magnets    wall plug           |        |        |           |          |    |
|    |        |        |           |          |    |
| <p style="text-align: center;">Qty 4    Qty 1    Qty 4    Qty 4    Qty 4</p>        |        |        |           |          |    |
|    |        |        |           |          |    |
| Magnets Special Qty 4   |        |        |           |          |    |
| Owners Book   |        |        |           |          |    |
|  |        |        |           |          |    |
| Restrictor Elbow  |        |        |           |          |    |
|  |        |        |           |          |    |
| Battery 9v  |        |        |           |          |    |
|  |        |        |           |          |    |
| Trim Edge Covers : 1 x White 1 x Black  |        |        |           |          |    |
| Warning Label   |        |        |           |          |    |
| Serial Number   |        |        |           |          |    |
| Inspector   |        |        |           |          |    |