

Owner's Manual

INCLUDES

User, Maintenance, Service, and Installation
Instructions



PARAGON SLIMLINE 3 & PARAGON SLIMLINE 3 LOW



Keep this booklet for service log and future reference

IMPORTANT



This appliance is guaranteed for 12 months subject to conditions. The 5 year extended parts warranty will only be valid if the annual service recommended in this manual has been completed and appliance has been registered online.

For use in Great Britain.

Literature NO 4575 (ISS 5)

Contents

EXTENDED FIVE YEAR PARTS WARRANTY	2
Benchmark Scheme	1
SECTION ONE Important Information (user instructions).....	3
SECTION TWO Operating the Appliance (users instructions).....	4
SECTION THREE Fuel Bed Layout (users instructions)	5
SECTION FOUR Cleaning (users instructions)	10
SECTION FIVE General Points (user instructions)	11
SECTION SIX Appliance Data (installation instructions).....	11
SECTION SEVEN Regulations and Warnings (installation instructions)	12
SECTION EIGHT Siting the Appliance (installation instructions).....	14
SECTION NINE To Install the Appliance (installation instructions).....	16
SECTION TEN Checking Operation of Fire (installation instructions).....	18
SECTION ELEVEN Maintenance (maintenance instructions).....	19
Short spares list	21
GAS FIRE COMMISSIONING CHECKLIST.....	24
SERVICE RECORD.....	25



EXTENDED FIVE YEAR PARTS WARRANTY

In order to validate your extended 5 years parts warranty please read the Benchmark Scheme on the opposite page and ensure your installer has filled in the appropriate checklist.

This in no way reduces your statutory rights

Your warranty commences from the date of purchase and you must retain your receipt or invoice as proof of a purchase date.

THIS EXTENDED WARRANTY SPECIFICALLY EXCLUDES GLASS AND SOFT REFRACTORY COMPONENTS, THE BULB AND ANY BATTERIES.

Terms and Conditions

1. The appliance must be installed by a GAS SAFE registered person.
2. The appliance must be used in accordance with the user's instructions.
3. The appliance must be serviced annually by a GAS SAFE registered person.
4. The benchmark and service log must be correctly filled out and the record of annual services must be up to date and supported by receipts in each case.
5. This warranty is not transferable and relates to the original installation only.
6. The appliance has not been subjected to misuse or accident or been modified or repaired by any person other than the authorised employee or authorised representative of Charlton and Jenrick Ltd.
7. The registration form must be returned within 1 month of purchase.

Technical Help Desk 01952 200 444

Benchmark Scheme



Charlton and Jenrick Ltd is a licensed member of the Benchmark Scheme which aims to improve the standards of installation and commissioning of domestic heating and hot water systems in the UK and to encourage regular servicing to optimise safety, efficiency and performance. Benchmark is managed and promoted by the Heating and Hotwater Industry Council. For more information and the full code of practice please visit www.centralheating.co.uk

Please ensure that the installer has fully completed the Benchmark Checklist on the inside back pages of the installation instructions supplied with the product and that you have signed it to say that you have received a full and clear explanation of its operation. The installer is legally required to complete a commissioning checklist as a means of complying with the appropriate Building Regulations (England and Wales).

All installations must be notified to Local Area Building Control either directly or through a Competent Persons Scheme. A Building Regulations Compliance Certificate will then be issued to the customer who should, on receipt, write the Notification Number on the Benchmark Checklist.

This product should be serviced regularly to optimise its safety, efficiency and performance. The service engineer should complete the relevant Service Record on the Benchmark Checklist after each service.

The Benchmark Checklist will be required in the event of any warranty.

It is a requirement that the gas fire is installed and commissioned to the manufacturer's instructions and the data fields on the commissioning checklist completed in full.

To instigate the guarantee, the gas fire needs to be registered with the manufacturer within one month of the installation.

To maintain the guarantee, it is essential that the gas fire is serviced annually by a Gas Safe registered engineer. The service details should be recorded on the Benchmark Service Interval Record and left with the householder.

Important

For future reference we suggest you record the following details here, and keep the receipt as proof of purchase. This information may be asked for when you contact the helpdesk.

MODEL:	Paragon Slimline 3 Manual	Serial No.	
---------------	----------------------------------	-------------------	--

This information can be found on the label attached to the packaging and on the data badge, which is located on the base of the appliance behind the control cover.

Retailer Name:	
Address:	
Date Of Purchase:	

Installer information required to register for the extended warranty

Name:	
Date of installation:	
Gas safe number:	

SECTION ONE Important Information (user instructions)

Consumer Protection Information

As manufacturers and suppliers of heating products, we take every care, as far as is reasonably practicable, that these products are so designed and constructed as to meet the general safety requirement when properly used and installed. To this end, our products are thoroughly tested and examined before despatch.

IMPORTANT NOTICE: Any alteration that is not approved by the appliance manufacturer could invalidate the approval of the appliance, operation of the warranty and could affect your statutory rights.

Health and Safety Notice

Important

This appliance could contain some of the materials, indicated below, that could be interpreted as being injurious to health and safety. It is the users / installers responsibility to ensure that the necessary personal protective clothing is worn when handling these materials, see below for information.

Artificial Fuels, Mineral Wool, Insulation Material, Refractory/Ceramic Fibres, Glass Yarn - *may be harmful if inhaled, may be irritating to skin, eyes, nose and throat.*

When handling *avoid inhaling and contact with skin or eyes. Use disposable gloves, facemasks and eye protection. After handling wash hands and other exposed parts. If a vacuum is used for cleaning the coals or cleaning after servicing / installation it is recommended that it be of the type fitted with a HEPA filter.*

Disposal of refractory/ceramic materials. To keep dust to a minimum these materials should be securely wrapped in polythene and be clearly labelled 'RCF waste'. These materials are not classified as 'hazardous' waste and should be disposed of at a site licensed for the disposal of industrial waste.

- The PARAGON SLIMLINE 3 is a decorative fuel effect appliance with a radiant heat conserver box for improved efficiency.
- This appliance is intended for decorative purposes.
- The PARAGON SLIMLINE 3 is designed and tested to the requirements of the EN 509.
- The appliance is for use on Natural Gas only and should be installed by a competent person i.e. Gas Safe-registered, in accordance with the GAS SAFETY (INSTALLATION AND USE) REGULATIONS.
- The chimney or flue (unless new or previously used with a gas appliance) should be swept before installation if it has been used for solid fuel.

WARNING

This appliance has a naked flame, as with all such fires it is recommended that a fireguard should be used for the protection of children, the elderly and infirm. Fireguards should conform to BS 6539 (1984) (Fireguards for use with solid fuel appliances).

INTRODUCTION

The PARAGON SLIMLINE 3 incorporates a single gas control, which selects ignition pilot, low or high settings. It is operated via a control knob located behind the ash pan cover.

The appliance incorporates a safety device in the form of an Oxygen Depletion System, which constantly monitors the oxygen in the room and will cause the fire to switch off if the oxygen level reduces, for instance due to insufficient ventilation or a blocked flue.

If this regularly occurs do not attempt to relight the appliance until a qualified engineer has checked it, the problem may not be due to lack of air or a defective flue.







The pilot can be left on or the pilot can be extinguished and relit each time the fire is used.

A fire front (fret) must be used with this appliance.

SECTION TWO Operating the Appliance (users instructions)

The appliance Control Knob is positioned behind the ash tray cover.

The full lighting procedure for the appliance is as follows: -

- A. Remove ash pan cover.
- B. Push knob in as far as possible on gas control.
- C. Turn knob anti-clockwise until a click is heard. The knob will stop at the position marked  and a flash should be seen at the left-hand side of the burner. At the same time the pilot flame should light. KEEP THE KNOB PRESSED IN FOR 20 SECONDS. Should the pilot fail to light, turn the control knob clockwise to the  position, and repeat the procedure.
- D. After lighting the pilot flame the control knob should be allowed to spring out slightly. This will allow you to turn the knob further anti-clockwise to the position marked . The pilot flame should then ignite the main burner.
- E. It is possible to adjust the height of the flames by turning the control knob between the positions marked  and . Note that the knob 'latches' in position at either end of this movement and must be pushed in slightly before it can be turned.
- F. To turn the burner off, depress the knob slightly and turn it to the  position.
- G. To completely extinguish the fire, depress the knob slightly and turn to  the position.
- H. Replace ash pan cover.

Note: - If the ignition fails the pilot can be lit with a taper or a match held at the pilot head. Remove fret for access and replace after lighting.

If the fire has extinguished for any reason wait 3 minutes before relighting.

SECTION THREE Fuel Bed Layout (users instructions)

It is important that all the coals, pebbles and moulded shapes are positioned as shown in these instructions.

Two alternative Fuel Beds are available:-

- A) COAL
- B) PEBBLE

Identify the fuel bed and assemble as shown below

COAL FUEL BED

Some soot deposits will form on the coals, this is perfectly normal and adds to the realism of the appliance. Some heat discolouration of the ceramic sides is normal and does not detract from the operation of the appliance in any way.

USE ONLY THE COALS PROVIDED - no additional coals MUST ADDED.

The Loose coal set consists of: -

- Rear Matrix
- Front Coal Matrix
- Loose Coals – 16 coals (Curved L shape)

- Ensure the rear matrix is in position as shown. Positioned well back against the rear of the appliance. Make sure that the burner slot is clearly visible as shown below.

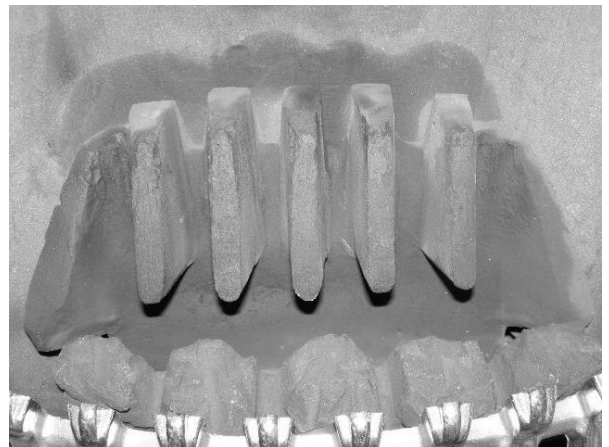

- Locate the front coal matrix with the shapes upwards in front of the rear matrix. Ensure that it is not placed on top of the burner slot.

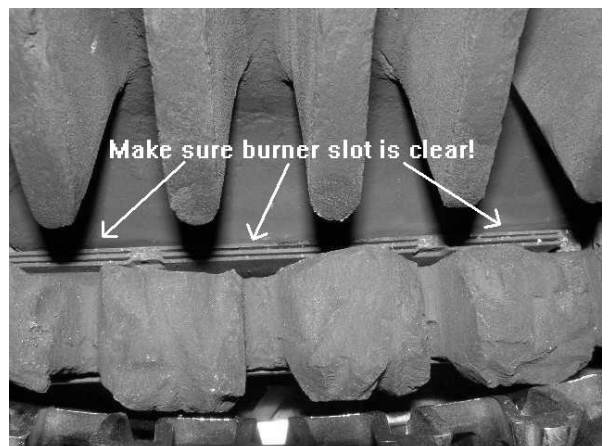

- slide front coal support on to the edge of the burner carrier this will support the front coal matrix and help stabilize the fuel bed

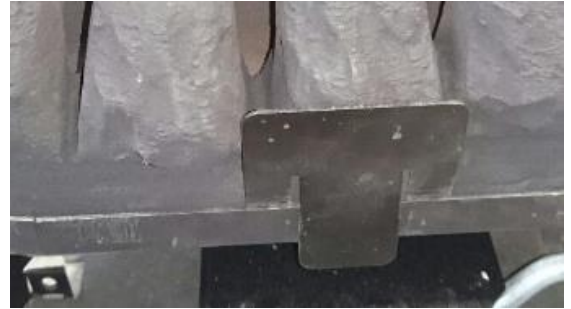

- Place the front row of **six** coals, as shown. Ensure these coals are supported by the front Matrix and the rear matrix and will not wobble or fall through on to the burner. This row is important to support the next rows properly. If necessary turn upside down and rotate to find stable positions. The positions shown in the photograph should be suitable.

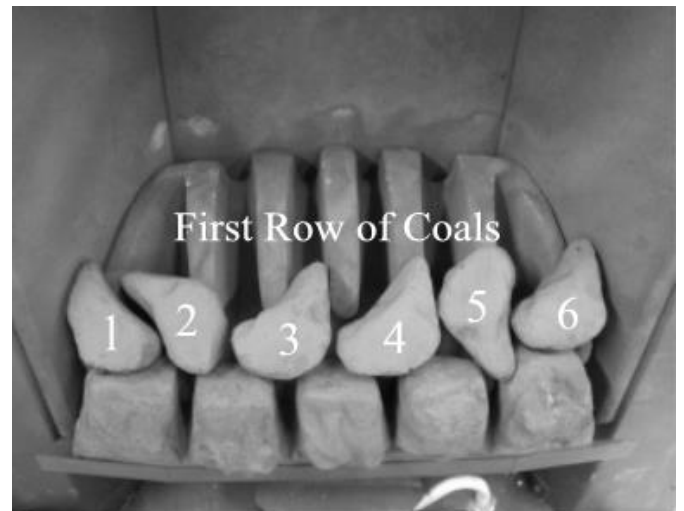

- Place the second row of **five** coals as shown. Ensure the coals bridge across the existing coals and the rear matrix and are stable. Press each one with your fingers to be sure that they are stable and will not fall through on to the burner. Re-position carefully as required.

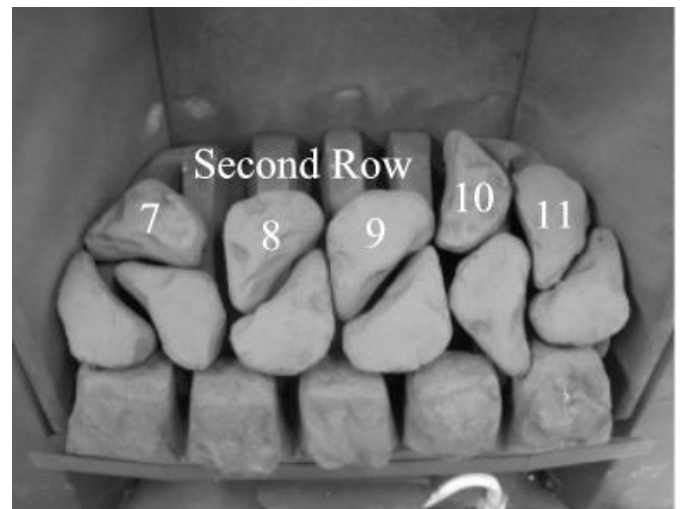

- Place the third row of **five** coals near the top of the rear matrix as shown.

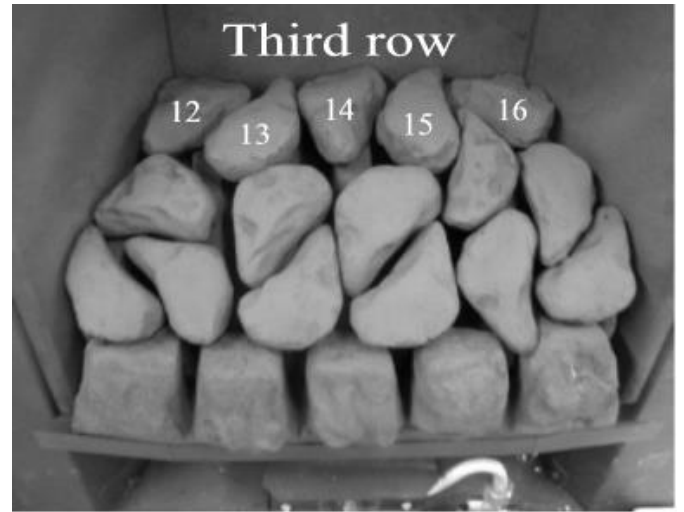

PEBBLE FUEL BED

Some soot deposits will form on the pebbles, this is perfectly normal and adds to the realism of the appliance. Some heat discolouration of the ceramic sides is normal and does not detract from the operation of the appliance in any way.

USE ONLY THE PEBBLES PROVIDED - no additional PEBBLES MUST ADDED.

The Loose Pebble set consists of: -

- Rear Matrix
- Front Matrix
- Loose Pebbles: – **13** Large, **3** Small. Quantities of grey and beige colours may vary.

- Ensure the rear matrix is in position as shown. Positioned well back against the rear of the appliance.
- Ensure the front pebble matrix is located behind the burner fascia as shown.
- **Make sure that the burner slot is clear as shown in the photograph.**

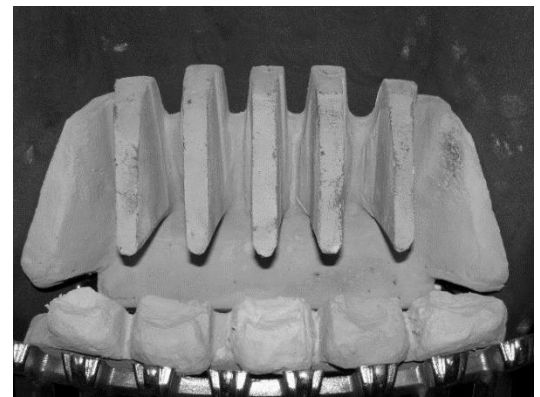

- slide front coal support on to the edge of the burner carrier this will support the front coal matrix and help stabilize the fuel bed



- Place the first row of **five** large pebbles as shown. So that they sit on the Front Matrix in the indents provided. Check that they are stable against the rear matrix by putting slight pressure on them with your fingers. Re-position any that are unstable. Mix the two grey and beige colours to give a pleasing layout.



- Place the second row of **four** large pebbles as shown, slightly overlapping the pebbles on the First row of pebbles. Again mix the colours.
- **Check stability of the layout and improve as necessary.** The pebbles are oval in shape and have a flat bottom so as to enable various positions to be tried to ensure stability.



- Place the third row of **four** pebbles on top of the rear matrix as shown. Again mix the colours.
- **Check stability of the layout and improve as necessary.** The pebbles are oval in shape and have a flat bottom so as to enable various positions to be tried to ensure stability.

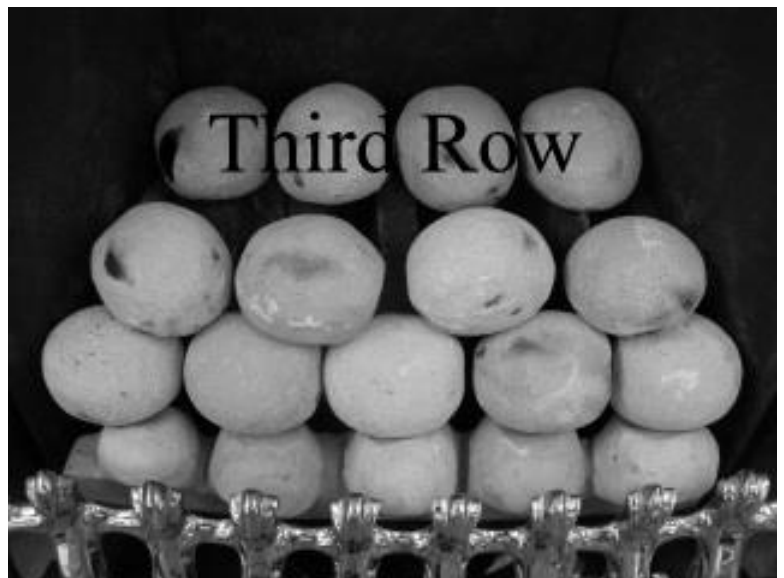

- Place the forth row of **three** small pebbles in the gaps between the last two rows as shown.
- **Check stability of the layout and improve as necessary.** The pebbles are oval in shape and have a flat bottom so as to enable various positions to be tried to ensure stability.



SECTION FOUR Cleaning (users instructions)

Warning: -Before you clean any part of the appliance ensure that the appliance is turned off and cold.

CLEANING: BRASS DECORATIVE TRIM & FRET

- The finish of the brass trim and fret may from time to time need cleaning with a proprietary brass cleaner i.e.: Brasso. Lacquered trims and frets will not need polishing. If in doubt check a small unobtrusive area before polishing the whole trim or fret.
- The trim and fret should be removed for cleaning. The fret should be removed before removing the trim, which is held in place by four magnets.

CLEANING: BLACK PAINTED or CHROME EFFECT SURFACES

- These surfaces should be dusted regularly and any marks removed with a soft cloth.
- Abrasive or chemical cleaner should never be used.

CLEANING COALS & PEBBLES

Important: - Refer to the Health & Safety Notice located on page 5 of this booklet before cleaning or replacing any refractory material.

- The coals, pebbles and ceramic parts are delicate and they should be handled with great care.
- The loose coals and pebbles may be removed for cleaning. They can be brushed very gently with a soft brush to remove dust or any deposits.
- Care should be taken to avoid contact with the refractory lining; this is a very delicate surface and should **not** be wiped or rubbed.
- A vacuum cleaner may only be used after all the loose coals and pebbles have been removed.

SECTION FIVE General Points (user instructions)

Like all appliances incorporating an aerated burner a low frequency noise may be heard, particularly on the low setting, this is quite normal and does not affect the operation of the appliance.

It is advised that the fire is serviced annually this is more likely to provide trouble-free operation.

It is important that: -

- The chimney or flue is checked annually to ensure clearance of combustion products.
- The fire does not normally require purpose-built ventilation but if for any special reason purpose-built ventilation is provided it should be checked periodically to ensure freedom from obstruction.
- Any debris from the chimney or flue should be removed. The fire should be allowed to cool for three to four hours before it is removed.
- Rubbish must not be thrown onto the fuel bed under any circumstances.
- The cast fire front must be positioned in front of the fire whilst it is burning

The only user removable parts are: -

- Cast fret
- Loose fuel bed components
- Decorative effect trim

SECTION SIX Appliance Data (installation instructions)

Category of appliance:..... BIIAS Category I_{2H}

Overall dimensions:..... Height 605mm (or 555mm for the Low version)

Width 505mm

Forward Projection:..... 75mm, (From fireplace opening including fret.)

Weight:..... 11kg (Boxed excluding fret)

9.5kg (Unboxed excluding fret)

Gas Type:..... G20 Natural Gas

Gas Pressure:..... 20 mbar +/- 1.0mbar

Pressure Test Point Location:..... Gas inlet elbow

Gas Input (Gross):..... 7.0 kW (Maximum) 2.4 kW (Minimum)

Injector:..... Marked 460A

Gas Connection:..... 8.0mm O/D, tube.

Data Badge Location:..... Behind decorative trim

NOTE: The efficiency of this appliance has been measured as specified in BS7977-1 2009+A1:2013 and the result is 58.5% The gross calorific value of the fuel has been used for this efficiency calculation. GASTEC have certified the test data from which it has been calculated. The efficiency value may be used in the UK Government's Standard Assessment Procedure (SAP) for energy rating of dwellings.

PACK CONTENTS

- Appliance
- Owners Instruction
- Foam Seal
- Trim

Refractory Fuel Bed Components

- Rear Matrix
- Front Matrix
- Loose Coals
- or Loose Pebbles

SECTION SEVEN Regulations and Warnings (installation instructions)

- THIS APPLIANCE MUST ONLY BE INSTALLED IN GREAT BRITAIN.
- THE APPLIANCE IS SUITABLE FOR USE ON NATURAL GAS ONLY.
- THE APPLIANCE IS INTENDED FOR DECORATIVE PURPOSES.
- (GB) NO SPECIAL VENTILATION BRICKS OR VENTS ARE REQUIRED INTO THE ROOM CONTAINING THE APPLIANCE, PROVIDING NORMAL ADVENTITIOUS ROOM VENTILATION EXISTS. THE INSTALLER MUST SATISFY THIS POINT BY CARRYING OUT THE MANDATORY SPILLAGE TEST.
- (IE) PERMANENT VENTILATION MUST COMPLY WITH THE REGULATIONS CURRENTLY IN FORCE.
- IT IS THE LAW THAT ALL GAS APPLIANCES MUST BE INSTALLED BY A COMPETENT PERSON; I.E. A GAS SAFE REGISTERED INSTALLER, IN ACCORDANCE WITH THE CURRENT GAS SAFETY (INSTALLATION AND USE) REGULATIONS (AS AMENDED), ALL RELEVANT PARTS OF THE LOCAL AND NATIONAL BUILDING REGULATIONS AND ALL RELEVANT RECOMMENDATIONS OF THE FOLLOWING BRITISH STANDARDS. FAILURE TO DO SO COULD LEAD TO PROSECUTION.

THE FOLLOWING ARE RELEVANT CODES OF PRACTICE AND BRITISH STANDARDS: -

BS 5871 PART 2

BS 8303

BS 5440 PART 1

BS 1251

BS 6891

BS 6461 PARTS 1 AND 2

BS 715

BS 1289 PART 1

Note:- This appliance must be installed to current versions of the above standards and include any relevant amendments.

THE BUILDING REGULATIONS ISSUED BY THE DEPARTMENT OF THE ENVIRONMENT.

THE BUILDING STANDARDS (SCOTLAND) (CONSOLIDATED) REGULATIONS ISSUED BY THE SCOTTISH DEVELOPMENT OFFICE.

PRIOR TO THE INSTALLATION ENSURE THAT THE LOCAL DISTRIBUTION CONDITIONS

(IDENTIFICATION OF TYPE OF GAS AND PRESSURE) AND ADJUSTMENT OF THE

APPLIANCE ARE COMPATIBLE. (G20 @ 20mbar)

WARNINGS

- This appliance has a naked flame, and with all such fires, it is recommended that a fireguard should be used for the protection of children, the elderly, or the infirm. Fireguards should conform to B.S.6539 (1984) (Fireguards for use with solid fuel appliances)
- This appliance incorporates a safety device in the form of an Oxygen depletion system. IT MUST NOT BE ADJUSTED OR PUT OUT OF OPERATION! THIS IS A NON SERVICEABLE ITEM AND MUST BE EXCHANGED AS A COMPLETE ASSEMBLY; USING ONLY THE ORIGINAL MANUFACTURER'S PART.
- A non-combustible hearth must be provided to comply with the building regulations, or a suitable proprietary fire surround with a 100°C minimum rating.
- During initial firing, an odour may be evident. This is the starch binder used during the manufacture of the fibre components of the fire, and there are no harmful effects produced.
- Care must be taken to prevent any damage being caused to surrounding soft furnishing or decoration, e.g. many embossed vinyl wall coverings may become discoloured if placed too close to the appliance.

IMPORTANT NOTES

A fire front (fret) must be used with this appliance and must conform to the following:

- It must be made from non-combustible material.
- Its general construction should enable it to stand firmly across the full width of the burner.
- The design of the fire front (fret) must have a removable ashtray cover (Lower section).
- The ash tray cover must have cut-outs and or holes which provide ventilation to the underside of the burner.
- The effective area of ventilation through the ash pan cover must be greater than 1365mm² (2.12 sq. ins.)

This appliance can be used in conjunction with the following chimneys:-

- Conventional brick or stone chimney,
- a pre-cast flue (subject to adequate draw) or
- a metal flue box conforming to BS 715, further details are covered in later text .

SECTION EIGHT Siting the Appliance (installation instructions)

Spacers are available in the following sizes 42mm, 30mm and 20mm these may be used to reduce the minimum depth required.

The fire can be installed in the following flues and locations:-

CLASS ONE

A conventional brick or stone chimney, with the builder's opening constructed of non-combustible material as used for a solid fuel appliance, with a minimum effective cross-sectional dimension of 225 x 225 mm (9 x 9 ins) or a lined flue (e.g. clay, metal etc.) with a minimum diameter of 125 mm (5 ins), with a minimum effective overall height of 3 metres (10 ft). A builder's opening a minimum of 550 mm high (or 505mm with Low lintel version) and 350 mm wide with a minimum depth of 170mm (or 140mm if flue as never been used for solid fuel) to allow sufficient volume for debris collection.

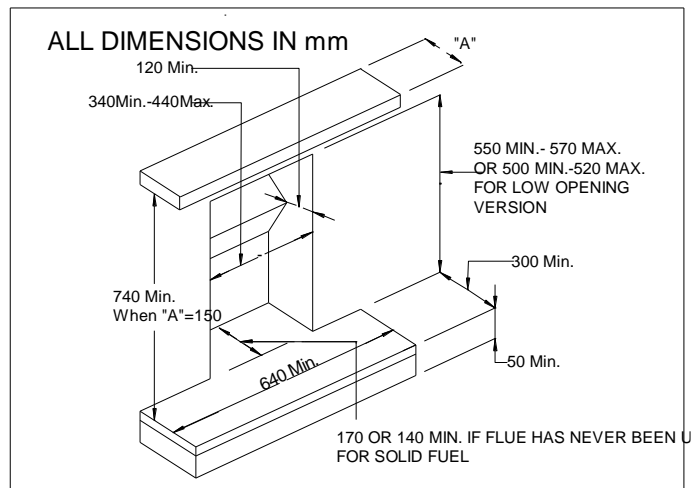

Any permanent flue restriction or variable dampers shall be removed or locked fully open. The chimney should be swept prior to installation if not new or previously used with a gas appliance.

IMPORTANT: - The restrictor plate pre-fitted on the appliance is suitable for installing the appliance into 150mm (6") diameter flue or larger. Bend down the restrictor plate if the appliance is installed into 125mm (5") diameter flue or pre-cast flues.

CLASS TWO

Pre-cast

A pre-cast flue correctly constructed conforming to the requirements of BS 1289: 1975, 1986 or 1989 with a minimum effective overall height of 3 metres (10 ft) which is correctly terminated (see BS 5440). It will normally require an additional thickness of 25mm in the form of a fireplace back panel or if it is intended to be fitted back to the plaster line then a spacer may be required to meet with the minimum depth requirement.

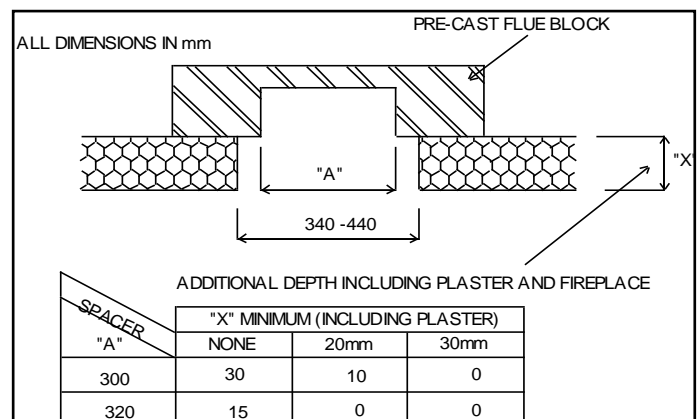

IMPORTANT: - Do not fit the restrictor plate if the appliance is installed into this type of flue.

Note: An inspection should be made to ensure that the internal walls of the flue are clear of mortar fangs. It is recommended that the plasterwork should not be directly bonded to the surface of the flue blocks, ensuring that there is a small air gap between the flue blocks and the wall surface. The fire can be installed with the plasterwork being directly bonded to the flue blocks but there is a risk of surface cracking occurring to the plaster above the appliance.

CLASS TWO

Fabricated metal

A double-walled or insulated metal flue box built to the requirements of BS 715 with a minimum diameter of 125 mm (5 ins) and a minimum effective overall height of 3 metres (10 ft).

IMPORTANT: - Bend down the restrictor plate if the appliance is installed into this type of firebox with a 5" flue.

Note: If the flue box is to be used with an existing brick or stone chimney a 125 mm (5 ins) minimum diameter flue liner conforming to BS 715 should be used.

Dampers or register plates must not restrict any of the above flues. The flue must only service a single appliance and not have any branches or traps that may impede the natural draught. If a terminal is fitted it must be suitable for the purpose (see 'Approved Flues & Terminals' published by BG Technology Certification Services).

- The front face (a minimum size of 605 mm (or 555mm for the Slimline 3 Low) x 505 mm wide) and the base of the fireplace opening must be flat to ensure that a good seal is formed between the rear and base of the appliance and the chimney to avoid any reduction of natural draught.
- A non-combustible hearth must be provided beneath the appliance within the fireplace opening, a fire-resisting hearth must also be provided symmetrically disposed about the fireplace opening a minimum thickness of 12 mm with the perimeter 50mm above floor level. With a minimum width of 640mm and a depth of 300 mm (add the spacer width to the hearth depth if a spacer is to be fitted i.e. for a 42mm spacer the hearth depth would be 342mm).
- Any combustible material above the opening must be removed up to a minimum height of 590 mm above hearth level.
- Purpose-built superimposed fire-resistant hearths and back panels, specified as suitable by the manufacturers, may be used, or a suitable proprietary fire surround with a 100 °C rating (minimum).

Clearance to Shelf or Surround

To check the compatibility of a combustible shelf or surround, refer to the chart.

Clearances at side of fire

Minimum width between vertical sides of combustible surround should not be less than 700 mm provided fire is central to surround and sides do not project more than 150 mm. When vertical side forward projection is increased by 12.5 mm add 50 mm to inside width of surround.

N.B. When fire is fitted this gives a minimum side clearance of 100mm.

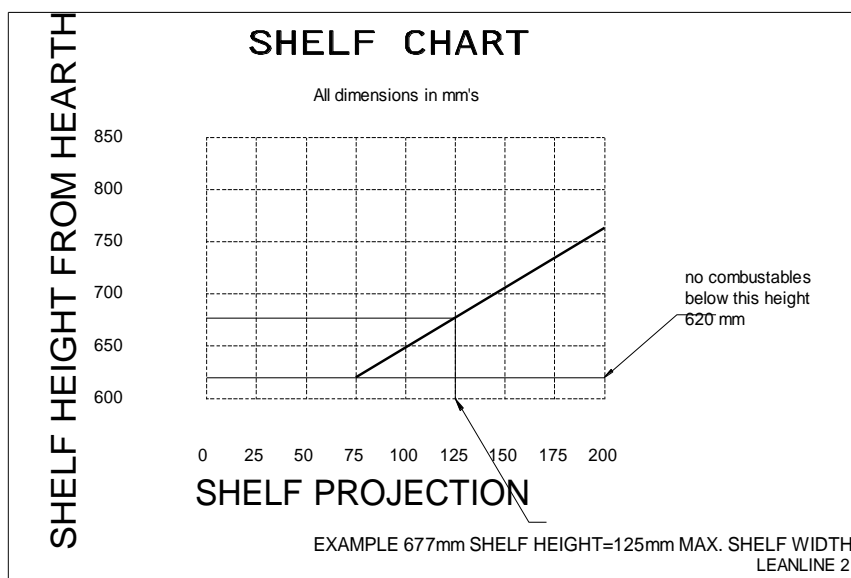

SECTION NINE To Install the Appliance (installation

instructions)

CHECKING THE FLUE AND FIRE OPENING

- Check that the chimney conforms to the required specifications as previously stated. Examine the condition and carry out any remedial work.
- If the flue has been used for solid fuel it should be swept prior to the installation.
- Prior to installing the appliance a smoke test (using a smoke bomb) should be carried out to check that satisfactory smoke clearance has been established. If all the smoke is not drawn into the flue, pre-heat the flue with a blowtorch or similar and re-check. If there is any uncertainty examine for the cause and, if necessary, seek expert advice.
- When installing this appliance against a dry lined (plasterboard) wall ensure that any void between the plasterboard and the wall is sealed with a suitable non combustible material (i.e. plaster or mortar).

CONNECTING THE GAS SUPPLY

Determine where the gas supply is to be connected to the appliance. This may be done from the front of the unit from either the left or right side, or a concealed fitting from the rear.

Concealed gas connection (from the rear)

Note: It may be necessary to remove the burner (4 screws) to aid installation.

- If the supply is to be a concealed connection it would be advisable to route the supply to the right side of the unit, taking into account the requirements of BS 6891 1988 dealing with enclosed pipes.
- A blind grommet is fitted to the rear of the appliance for the entry of the gas pipe (a hole should be cut in the grommet to fit the supply pipe the grommet must be put back into place to seal box).
- An 8mm restrictor elbow is provided positioned under the fire on the right-hand side with a compression connection at the outlet.
- The pipe can then be routed under the burner tray and onto the inlet elbow.

Visible gas connection (to the front, from the left or right)

- Connections may be made from the front of the appliance from either the left or right in 8mm diameter pipe.
- The inlet elbows can be rotated to the required position and the end of the 8mm gas feed pipe formed to route into the inlet elbow.
- A suitable means of isolation must always be fitted in the supply feed to the fire to facilitate servicing.

FIXING BACK TO OPENING

- Remove the paper backing from the length of foam seal and stick it to the rear flange of fire.
- If a spacer box is going to be used stick the second length around the rear face of the spacer unit,. THE FOAM SEAL MUST BE POSITIONED TO ENSURE AN AIR TIGHT SEAL WHEN THE APPLIANCE IS FITTED.
- DO NOT use permanent sealing compounds i.e. silicone sealant this could cause the appliance to be damaged when it is removed for servicing.
- If the spacer box is not being used, mark position of flange hole in the fireplace front and fix firebox in position with wall plugs and wood screws.

- If spacer box is being used fix the spacer-box to the fireplace first with wood screws and wall plugs then screw firebox to spacer box using screws provided.

OPTIONAL CABLE FIXING SYSTEM

(for use when fixing to 18" openings or when it is desirable not to drill the fireplace fascia) it may not be possible to use with some pre-cast flues.

- Drill 4 holes in the rear of the fireplace opening in the position shown and fix securely the 4 eye bolt with screws and wall plugs provided.
- Fix the fire casing back into the opening using the cable fixing system as shown do not cut off loose ends of cable after fixing, coil and tuck carefully into space to the sides of the burner unit.

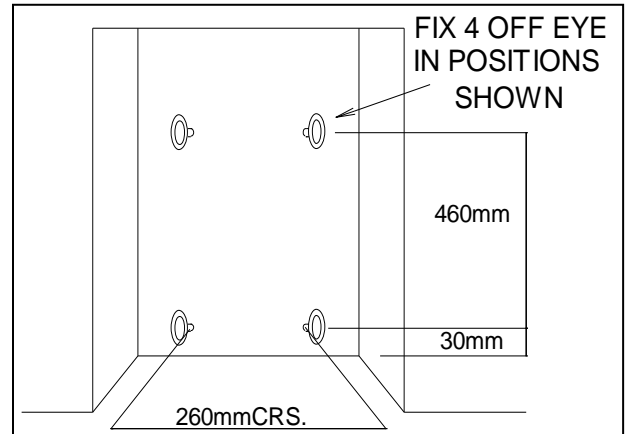

Note: When using the cable fixing kit with the spacer, fix and seal the spacer to the rear of the appliance flange with the screws and foam seal provided.

Gas Soundness Test

Turn on the gas supply to the appliance and check for soundness in accordance with current codes of practice.

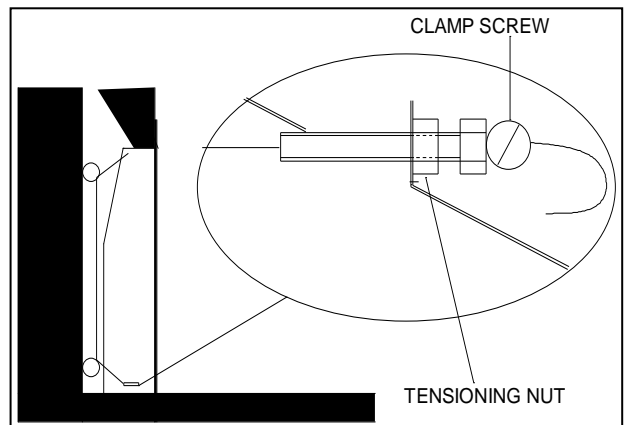

Check Burner Pressure and General Operation

- Remove the screw from the pressure test point on the inlet elbow and fit pressure gauge.
- Turn on the gas to the appliance.
- Purge the air from the appliance by rotating the control to the ignition position, push in to allow the air in the pipe work to be purged and the piezo to ignite the pilot.
- Check that the electrode is sparking at the gap between the thermocouple tip and the electrode, continue until pilot ignition is established.
- Depress the control knob slightly and rotate anti-clockwise until the index symbol is aligned with the  on indicator label, release and allow the appliance to run.
- Check the inlet pressure is 20 ± 1 mbar.

Fuel Bed Layout

Important: - Refer to the 'Health & Safety Notice Located on page 3 of this booklet before cleaning or replacing any refractory material.

It is important that all the coals, pebbles and moulded shapes are positioned as shown in these instructions. Lay coal and Pebbles as shown.

USE ONLY THE COALS OR PEBBLES PROVIDED AND no additional coals OR PEBBLES MUST be ADDED.

SECTION TEN Checking Operation of Fire (installation instructions)

Checking Product Clearance

- Check for satisfactory clearance of combustion products, close all doors and windows and leave fire burning for five minutes.
- Insert lighted smoke match 10mm into the fire immediately under the canopy, move match horizontally along from one side to the other all the smoke should be drawn into the flue.
- If spillage occurs, allow a further 5 minutes. Should spillage still occur, turn off the fire, bend down the restrictor plate (if fitted) and repeat clearance otherwise seek expert advice.
- If an extractor fan is situated in the room this test should be repeated with the fan running. If there is a connected room with an extractor fan, the test should be repeated with all the doors to that room opened and the extractor fan running at maximum setting. Should spillage occur seek expert advice.

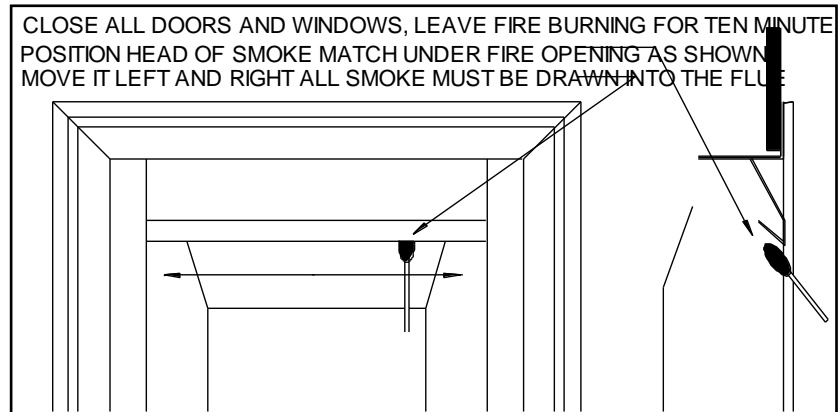

Fit the fire front and trim

- Fit the trim front with the 4 magnetic strips placed on the vertical side flanges of the firebox - one on the top and one at the bottom of each side, and fit the fire front.
- Offer the decorative trim up squarely and centrally and push into position.

ADVISE CUSTOMER THAT:

The curing effect of heating the coals, pebbles and other ceramic components will cause an initial odour. This is due to the starch used in the manufacturing process and is non-toxic. Any debris should be cleaned from the appliance. A vacuum cleaner can be used but only after all the Loose coals or pebbles have been removed. The appliance should be serviced annually by a competent person in accordance with these instructions and the appliance checked for spillage in accordance with the method detailed in these instructions.

Demonstrate the lighting and extinguishing procedures to the user and the removal and refitting of the decorative trim for cleaning.

If ventilation is fitted for any reason it must be checked regularly to ensure freedom from obstructions.

Hand these instructions over to the user.

SECTION ELEVEN Maintenance (maintenance instructions)

- Servicing should be carried out annually by a competent person such as a Gas Safe registered person in accordance with the relevant regulations, to ensure the safe and correct operation of the appliance.
- Before commencing any service or replacement of parts, turn off the gas supply to the fire. After servicing check for gas soundness.
- When ordering spare parts please quote appliance name and serial number these can be found on the data badge, which is located by removing the decorative fire trim.
- At least once a year, check for debris in the catchment area behind the fire and in the flue way.
- If soot has accumulated check to establish cause, rectify and clean flue or chimney accordingly.
- Examine the coals for signs of cracking and replace if necessary. **IMPORTANT: - REFER TO THE 'HEALTH & SAFETY NOTICE LOCATED ON PAGE 4 OF THIS BOOKLET BEFORE CLEANING OR REPLACING ANY REFRACTORY MATERIAL.** Refer to coal layout procedure Pages 5 & 9 before attempting to replace coals or pebbles, which should only be replaced as a complete set with no extra coals or pebbles added.
- Check pilot aeration holes for linting; use a vacuum cleaner to remove any lint taking care not to damage the pilot head.

Replacement of Gas Control

1. Turn off the gas supply by the isolating cock.
2. Remove fire fret.
3. Remove all loose coals or pebbles.
4. Remove moulded refractory parts except back board which can stay in place.
5. Remove 4 screws fixing burner tray into the casing.
6. Disconnect fire at inlet elbow and remove burner tray from the casing.
7. Pull off control knob and undo the gas valve-mounting bracket nut.
8. Undo the three compression nuts securing the pipes to the gas valve.
9. Clean, service or replace gas valve.
10. Re-assemble the in reverse order.
11. Turn on the gas supply, check for soundness and recommission appliance.

Replacement of Injector

1. Repeat operations 1-4 for removal of gas control.
2. Remove the two screws retaining the burner bar. Remove the silencer
3. Undo injector Lock nut and compression nut and remove the injector.
4. Clean or replace injector.
5. Re-assemble in reverse order making sure the U of the silencer is open side downwards.
6. Turn on the gas supply, check for soundness and recommission

Replacement of Silencer





1. Repeat operations 1-4 for removal of gas control.
2. Remove the two screws retaining the burner bar.
3. Remove the silencer.
4. Clean or replace silencer ensuring that it is put back with the open side of the U downwards.
5. Re-assemble in reverse order.

Replacement of Oxy-Pilot Assembly

NOTE: If the pilot assembly is replaced it must be replaced by an identical unit from the same manufacturer and replaced as a complete unit.

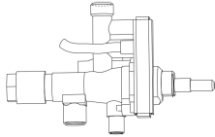
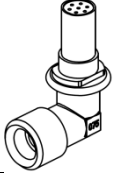
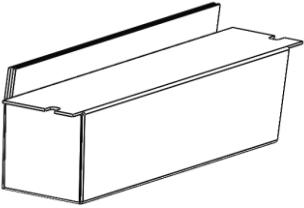
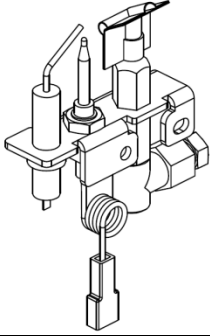
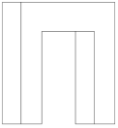
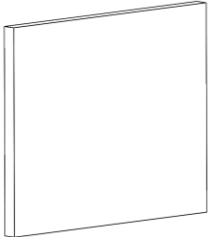
1. Repeat operations 1-6 for removal of gas control.
2. Disconnect the thermocouple from the gas valve.
3. Disconnect the gas connection from the pilot assembly.
4. Remove ignitor lead from pilot assembly.
5. Undo the screws securing the oxy-pilot to the burner.
6. Clean or replace oxy-pilot (NOTE: - THIS IS A NON-SERVICEABLE DEVICE AND MUST NOT BE ADJUSTED).
7. Re-assemble the in reverse order.
8. Turn on the gas supply, check for gas soundness and recommission appliance.

Short spares list

Image	Description	Part number
	Valve	5932
	Injector stamped: 460A	2799
	Burner Bar	NG: 3197
	Oxy pilot 2550 NG	6952
	Silencer	4819
Back liner board	4643 Low Lintel: 4687	
L/H liner board	4644 Low Lintel: 4689	
R/H liner board	4645 Low lintel: 4688	
Top liner board	4646	

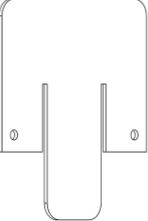
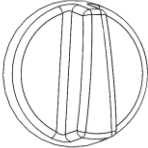
	Coal support	2889
	Control knob	4278

Register your appliance online today to active your warranty



GAS FIRE COMMISSIONING CHECKLIST

This Commissioning Checklist is to be completed in full by the competent person who commissioned the gas fire as a means of demonstrating compliance with the appropriate Building Regulations and then handed to the customer to keep for future reference.

Failure to install and commission according to the manufacturer's instructions and complete this Benchmark Commissioning Checklist will invalidate the warranty. This does not affect the customer's statutory rights.

Site Requirements	Yes	N/A
Was the chimney checked to ensure it only serves one flue/fire, has no obstructions and is continuous?		
Has any debris at the base of the chimney been removed?		
For brick chimney installations is there enough depth for 12 litres of debris, or precast flues 2 litres of debris? (see instructions for debris gap details)		
Have damper and register plates been removed or locked in the fully open position ensuring correct size of flue is maintained?		
If previously used for solid fuel has the chimney been thoroughly swept?		
If the chimney is pre-cast has the inside of the flue been checked for extruded cement / sealant which must be removed?		
Has the fire place been checked for under-floor air supply which must be sealed off?		
Has the chimney been inspected prior to fitting the gas fire to ensure that it is in good condition?		
Has the structure of the chimney been checked for leakage using a smoke pellet test? (See BS5440-1 for details).		
Ventilation		
Does the installation require any additional ventilation requirements as detailed in the manufacturer's instructions?		
Hearth Requirements- where fitted		
Is the hearth constructed from non -combustible material?		
Is the hearth a minimum of 12mm thick with a minimum floor to top surface of 50mm?(BS5871) or as per manufacturer's instructions?		
Is the hearth for open fronted fires a minimum of 760mm wide and has 300mm projecting from the fire opening (BS6871) or to manufacturer's instructions?		
Mounting height (where applicable) has the fire been installed to the correct mounting height- as per manufacturer's instructions?		
Firebox and Fuel Bed		
Has the fuel bed, coals, pebbles etc. been fitted to manufacturer's instructions?		
Gas Supply		
Has an isolation tap/restrictor inlet elbow been fitted for servicing?		
Has the gas supply been thoroughly purged prior to connection to remove any debris?		
Has a gas tightness test been completed prior to breaking into the gas supply and following completion of installation?(IGEM/UP/1B)		
Record burner gas pressure reading? If only the supply pressure is available a gas rate must be undertaken.(GSIUR REG26/9C)		
Record dynamic inlet gas pressure (working pressure) reading (all gas appliances running)		
Spillage test		
Installation passes smoke match test with any extractor fans turned on (see manufacturer's instructions)		
Installation		
Has the gas fire been installed and commissioned in accordance with manufacturer's instructions?		
Has the fire been installed with the correct clearance to combustible materials, as per manufacturer's instructions?		
The operation of the appliance and controls have been demonstrated to the customer including battery replacement where applicable?		
The manufacturer's literature, including Benchmark Checklist and Service record has been explained and left with the customer?		
Has the appliance been registered with the Local Authority as detailed on the Gas Safe web site and is a legal requirement and forms part of the warranty?		
Customer's Signature: (To confirm satisfactory demonstration and receipt of manufacturer's literature)	Commissioning Engineer's Signature:	

*All installations in England and Wales must be notified to be Local Authority Building Control (LABC) either directly or through a Competent Persons Scheme. A Building Regulations Compliance Certificate will then be issued to the customer.

SERVICE RECORD

It is essential that your gas fire is serviced regularly and that the appropriate Service Interval Record is completed. Service Provider

Before completing the appropriate Service Record below, please ensure you have carried out the service as described in the manufacturer's instructions. Always use the manufacturer's specified spare part when replacing controls.

SERVICE 01	Date:
Engineer name:	
Company name:	
Telephone No:	
Gas safe register No:	
Comments:	
Signature	

SERVICE 02	Date:
Engineer name:	
Company name:	
Telephone No:	
Gas safe register No:	
Comments:	
Signature	

SERVICE 03	Date:
Engineer name:	
Company name:	
Telephone No:	
Gas safe register No:	
Comments:	
Signature	

SERVICE 04	Date:
Engineer name:	
Company name:	
Telephone No:	
Gas safe register No:	
Comments:	
Signature	

SERVICE 05	Date:
Engineer name:	
Company name:	
Telephone No:	
Gas safe register No:	
Comments:	
Signature	

Paragon Slimline 3 Packing – Coal			
Product	0908	Serial No	HE
ID Label	0918 (Lo)		Prefix

Paragon Slimline 3 Packing – Pebble			
Product	0909	Serial No	HE
ID Label	0919 (Lo)		Prefix

Fire Box Labels	
Spillage(Pair)	
Data Badge	
Fire Box Grommet	
Burner Tray / Box Assembly	
Refractory Back & Sides	
Warning Label (Fire Guard)	
Front coal support (2889)	
Fuel bed (7581)	
Fixing (0705) (includes 4 magnets & foam seal)	
Owners Book	
ID Label & Packing Label	
Serial Number	
Inspector	

Fire Box Labels	
Spillage (Pair)	
Data Badge	
Fire Box Grommet	
Burner Tray / Box Assembly	
Refractory Back & Sides	
Warning Label (Fire Guard)	
Front coal support (2889)	
Loose Pebble Set (5577)	
Rear Matrix (5573)	
Front Matrix (5575)	
Fixing (0705) (includes 4 magnets & foam seal)	
Owners Book	
ID Label & Packing Label	
Serial Number	
Inspector	