

Owner's Manual

INCLUDES

User, Maintenance, Service, and Installation
Instructions

Edge BF & Edge 3s BF Gas Stove



Keep this booklet for service log and future reference

IMPORTANT



This appliance is guaranteed for 12 months subject to conditions. The 5 year extended parts warranty will only be valid if the annual service recommended in this manual has been completed and appliance has been registered online.

For use in Great Britain.

Literature NO 8019 (Issue 3)

Contents

EXTENDED FIVE YEAR PARTS WARRANTY	2
Benchmark Scheme	3
SECTION ONE Introduction (Users Instructions)	5
SECTION TWO Operating the Appliance (Users Instructions).....	7
SECTION THREE Cleaning (Users Instructions)	8
SECTION FOUR Fuel Bed Cleaning and Layout (Users Instructions).....	9
Log fuel bed layout.....	9
SECTION FIVE General Points (Users Instructions)...	13
SECTION SIX Appliance Data (Installation Instructions).....	13
Appliance Dimensions.....	15
SECTION SEVEN Regulations and Warnings (Installation Instructions).....	16
SECTION EIGHT Siting the Appliance (Installation Instructions).....	17
General Requirements	17
SECTION NINE Preparing the Appliance for Installation	18
SECTION TEN Installing the Appliance (Installation Instructions).....	23
TIMBER FRAMED DWELLING.....	25
TOP FLUE UP & OUT	26
Optional flue lengths.....	27
SECTION ELEVEN connecting the gas supply (Installation Instructions).....	28
SECTION TWELVE Checking Operation of Fire (Installation Instructions).....	30
SECTION THIRTEEN Maintenance (Maintenance Instructions).....	31
SECTION FOURTEEN Wiring Diagram (Maintenance Instructions).....	33
SECTION FIFTEEN Short Spares List	34
GAS FIRE COMMISSIONING CHECKLIST.....	38
SERVICE RECORD	39



EXTENDED FIVE YEAR PARTS WARRANTY

In order to validate your extended 5 years parts warranty please read the Benchmark Scheme on the opposite page and ensure your installer has filled in the appropriate checklist.

This in no way reduces your statutory rights

Your warranty commences from the date of purchase and you must retain your receipt or invoice as proof of a purchase date.

THIS EXTENDED WARRANTY SPECIFICALLY EXCLUDES GLASS AND SOFT REFRACTORY COMPONENTS AND ANY BATTERIES.

Terms and Conditions

1. The appliance must be installed by a GAS SAFE registered person.
2. The appliance must be used in accordance with the user's instructions.
3. The appliance must be serviced annually by a GAS SAFE registered person.
4. The benchmark and service log must be correctly filled out and the record of annual services must be up to date and supported by receipts in each case.
5. This warranty is not transferable and relates to the original installation only.
6. The appliance has not been subjected to misuse or accident or been modified or repaired by any person other than the authorised employee or authorised representative of Charlton and Jenrick Ltd.
7. The registration form must be returned within 1 month of purchase.
8. **Technical Help Desk 01952 200 444**



Charlton and Jenrick Ltd is a licensed member of the Benchmark Scheme which aims to improve the standards of installation and commissioning of domestic heating and hot water systems in the UK and to encourage regular servicing to optimise safety, efficiency and performance. Benchmark is managed and promoted by the Heating and Hotwater Industry Council. For more information and the full code of practice please visit www.centralheating.co.uk

Please ensure that the installer has fully completed the Benchmark Checklist on the inside back pages of the installation instructions supplied with the product and that you have signed it to say that you have received a full and clear explanation of its operation. The installer is legally required to complete a commissioning checklist as a means of complying with the appropriate Building Regulations (England and Wales).

All installations must be notified to Local Area Building Control either directly or through a Competent Persons Scheme. A Building Regulations Compliance Certificate will then be issued to the customer who should, on receipt, write the Notification Number on the Benchmark Checklist.

This product should be serviced regularly to optimise its safety, efficiency and performance. The service engineer should complete the relevant Service Record on the Benchmark Checklist after each service.

The Benchmark Checklist will be required in the event of any warranty.

It is a requirement that the gas fire is installed and commissioned to the manufacturer's instructions and the data fields on the commissioning checklist completed in full.

To instigate the guarantee, the gas fire needs to be registered with the manufacturer within one month of the installation.

To maintain the guarantee, it is essential that the gas fire is serviced annually by a Gas Safe registered engineer. The service details should be recorded on the Benchmark Service Interval Record and left with the householder.

Important

For future reference we suggest you record the following details here, and keep the receipt as proof of purchase. This information may be asked for when you contact the helpdesk.

MODEL:	Edge / Edge 3s BF GAS STOVE	Serial No.	
---------------	--	-----------------------	--

This information can be found on the label attached to the packaging and on the data badge, which is located on the back of the door of appliance.

Retailer Name:	
Address:	

Important: – These products must be installed by a suitably qualified Installer.

Installer information required to register for the extended warranty

Name:	
Date of installation:	
Gas safe number:	

SECTION ONE Introduction (Users Instructions)

Consumer Protection Information

As manufacturers and suppliers of heating products, we take every care, as far as is reasonably practicable, that these products are so designed and constructed as to meet the general safety requirement when properly used and installed. To this end, our products are thoroughly tested and examined before despatch.

IMPORTANT NOTICE: Any alterations that are not approved by the appliance manufacturer could invalidate the approval of the appliance, operation of the warranty and could affect your statutory rights.

Health and Safety Notice

Important

This appliance could contain some of the materials, indicated below, that may be interpreted as being injurious to health and safety. It is the users / installers responsibility to ensure that the necessary personal protective clothing is worn when handling these materials, see below for information.

Artificial Fuels, Mineral Wool, Insulation Material, Refractory/Ceramic Fibres, Glass Yarn - *may be harmful if inhaled, may be irritating to skin, eyes, nose and throat.*

When handling *avoid inhaling and contact with skin or eyes. Use disposable gloves, facemasks and eye protection. After handling wash hands and other exposed parts. If a vacuum is used for cleaning the Logs or cleaning after servicing / installation it is recommended that it be of the type fitted with a HEPA filter.*

Disposal of refractory/ceramic materials. To keep dust to a minimum these materials should be securely wrapped in polythene and be clearly labelled 'RCF waste'. These materials are not classified as 'hazardous waste and should be disposed of at a site licensed for the disposal of industrial waste.

Introduction

- The Edge / Edge 3s BF has been designed and tested for use in GB (Great Britain).
- The Edge / Edge 3s BF incorporates a single gas valve which selects ignition pilot, with variable setting between low and high setting and is operated via remote control hand device . This system is powered by mains electricity via pre-wired transformer plus supply cord. Alternative power supply is available for users during mains interruptions.
- The Edge / Edge 3s BF is an inset room sealed decorative fuel-effect gas appliance.
- The Edge / Edge 3s BF is available in natural gas or LPG.
- The Edge / Edge 3s BF **must not** be installed into a natural draught flue or chimney.
- The Edge / Edge 3s BF should only be installed and serviced by a competent person i.e. GAS SAFE registered, in accordance with the GAS SAFETY (INSTALLATION AND USE) REGULATIONS.
- The Edge / Edge 3s BF does not require a chimney, but **must be** installed so it can flue to an outside wall.
- It is important that the flue terminal is regularly checked and kept clear at all times.
- If the terminal is accessible to people (i.e. less than 2m above a walkway, balcony etc.) a terminal guard must be fitted to prevent access to the flue outlet, which becomes hot when the fire is in use.
- As the Edge / Edge 3s BF is a room sealed appliance (i.e. air for the combustion process is taken from outside the room) no purpose built ventilation is required.
- The Edge / Edge 3s BF is designed and tested to meet the requirements of the European Standard EN 613.
- Like all appliances incorporating an aerated burner a low frequency noise may be heard, this may be more noticeable on the low setting. To obtain an authentic fire sound, a noise maybe noticeable from the burner.

Important Information

- The Edge BF is for use on Natural Gas (G20 @ 20mbar) or LPG (G31 @ 37mbar).
- The Edge 3s BF is for use on Natural Gas (G20 @ 20mbar) only.
- Failure to install appliance correctly could lead to prosecution.

In GB (Great Britain), the appliance must be installed by a competent person i.e. GAS SAFE registered, in accordance with the GAS SAFETY (INSTALLATION AND USE) REGULATIONS, The Building Regulations (or The Building Regulations (Scotland)) and The Current I.E.E. Wiring Regulations, if appropriate.



- The glass front of this fire acts as a dress guard, conforming to BS 1945 (1997) however; a fireguard conforming to BS6539 (1997) must be used to protect young children, the elderly or infirm.
- The appliance **MUST NOT** be used with the glass safety screen removed or if it is damaged or cracked.
- During initial firing, an odour may be evident. This is the starch binder used during the manufacture of the fibre components of the fire, and there are **no harmful** effects produced.
- During the normal operation of the fire some black staining may appear on some parts of the fuel bed. This is quite normal and adds to the appearance of the appliance. However, if excessive black staining does occur it may be due to the fuel bed being incorrectly laid. This should be checked prior to contacting a service engineer.
- Care must be taken to prevent any damage being caused to surrounding soft furnishing or decoration; e.g. many embossed vinyl wall coverings may become discoloured if placed too close to the appliance. Combustible material i.e. wall panelling or wallpaper must be removed from behind the fire.
- It is advised that this appliance is serviced annually; as it is more likely to provide trouble-free operation.

SECTION TWO Operating the Appliance (Users Instructions)

To light the appliance using the remote handset:

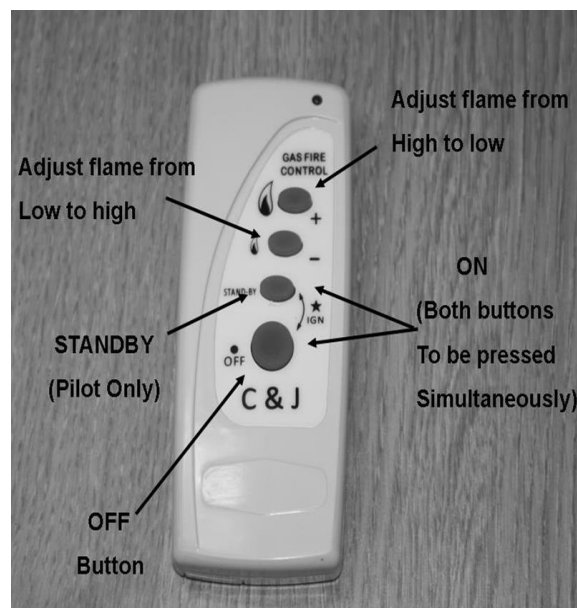
- A. Point the remote control handset in the direction of the appliance and simultaneously press the buttons marked '●' off' and 'standby'. Continue to hold in these two buttons until a 'bleep' is heard (approximately 2-3 sec.) and then release these buttons. The appliance will automatically go through the ignition sequence and the pilot should ignite. Once the pilot is alight the appliance will automatically go to the high setting (approximately 20-25sec). If the ignitor stops sparking and the pilot fails to light, repeat this procedure.
- B. The appliance can be adjusted up or down by pressing the



appropriate button  (low setting) or  (high setting). There are 5 heat settings and the fire will give a double bleep when the maximum or minimum heat setting is reached. To switch off the appliance press the OFF  button or if the appliance is to be switch off for a short period it is recommended that the 'standby' button be used.

- C. The appliance can be switched off without using the handset by unplugging the transformer. When the transformer is removed there will be a delay (up to 3minutes) after which double bleeps may be heard and shortly after the appliance will extinguish. Ensure that the transformer is reconnected once the fire as been extinguished. The appliance cannot be operated without the use of the handset. If the fire fails to light or extinguishes for any reason, it will be necessary to re-set the fire. This can be done by pressing the off  button then following the normal lighting procedure.

Note: if repeated delayed ignition is experienced during start-up it is recommended that the appliance is checked by a gas safe engineer

NOTE: If the fire is extinguished for any reason wait 3 minutes before relighting.

Low Battery Indication (Handset)

If while pressing any of the buttons on the remote handset the low battery indicator lamp either stops flashing or appreciably slows then the battery should be changed.

To Replace Batteries in Handset (AAA 1.5 v Ir3 x2)

Remove the cover from the rear of the handset and fit replacement batteries, taking note of the orientation.

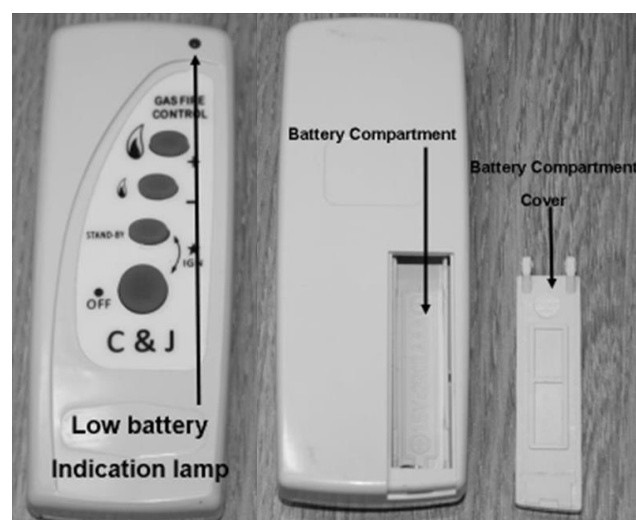

SECTION THREE Cleaning (Users Instructions)

Warning: -

Before you clean any part of the appliance ensures that the appliance is turned off and cold.

Cleaning: Black Painted Surfaces

The outer body simply needs to be dusted or wiped with a clean cloth from time to time. DO NOT use wet cloths as it can spread plaster, cement, fire cement or fire board dust and subsequently cause the paint to turn grey with heat where it has been wiped. DO NOT use any kind of furniture polish or cleaning agent other than your stove suppliers recommended paint. All painted stoves will require some re-painting from time to time. The stove can simply be re-painted by using high temperature stove spray paint after rubbing down with wire wool or similar abrasive to remove all loose debris from the surfaces.

Stove paint finishes will require touching up or re-painting from time to time and failure to maintain the surface finish can lead to unnecessary corrosion. Looking after the paint finish is normal maintenance and not covered by warranty.

Glass Cleaning

From time to time it will be necessary to clean the glass panel of your Edge BF Gas Stove. We recommend you use a Ceramic hob cleaner these are available for all leading super markets: - i.e. ASDA, TESCO, SAINSBURY'S Etc.

Brands of hob cleaning we have tested and found suitable are - **HOB BRITE & VITRO CLEAN.**

- Ensure the fire as been turned OFF for at least four hours to ensure it is cool.
- Pull forward on the door to disengage the lower magnets and lift the door upwards to remove.
- Loosen the lower 3 M4 fixing nuts but do not remove.
- Remove the 9 off M4 fixing nuts from the glass fixing brackets located at the top and sides of the glass panel.
- Remove the top and side fixing brackets while supporting the glass panel.
- Lift the glass panel from within the bottom support bracket.
- Follow the instructions on the Hob Cleaner Bottle.
- On stubborn stains (where the appliance as been used for a long period without glass panel being cleaned), use a new Brillo Pad well wetted with the Hob cleaner applied directly to it.
- Ensure all residue of the cleaner is removed with a damp cloth and the glass panel is completely dry before refitting the glass.

Important: - The appliance must not be used if the glass panel is missing or damaged.

Note: - The glass may discolour quickly when first installed, and it should be cleaned. This is due to the burning off process of the refractory shapes.

SECTION FOUR Fuel Bed Cleaning and Layout (Users Instructions)

Warning: -

- Before you clean any part of the appliance ensures that the appliance is turned off and cold.
- Use only the fuel bed components provided and no additional parts must added.
- Incorrect positioning of the fuel bed components could result in the staining of the glass panel.

Important: - Refer to the 'Health & Safety Notice located on page 5 of this booklet before cleaning or replacing any refractory material.

- The fuel bed components are delicate and they should be handled with great care.
- The loose log shapes may be removed for cleaning. They can be brushed very gently with a soft brush to remove dust or any deposits.
- A vacuum cleaner may only be used after the loose log shapes and vermiculite has been removed.

CARE SHOULD BE TAKEN TO AVOID DAMAGE TO THE LOG SHAPES AS THESE ARE A DELICATE SURFACE AND SHOULD **NOT** BE WIPED OR RUBBED.

It is important that all the log fuel bed shapes are positioned as shown in these instructions.

Log fuel bed layout



Place log shape No1 on its locating pin at the centre rear of the burner. Place a thin layer of vermiculite on the burner taking care around the burner ports. Failure to do so can result in excessive sooting on the appliance.

Locate the front cover plate onto the locating screws ensuring it is tight against the front of the fire.

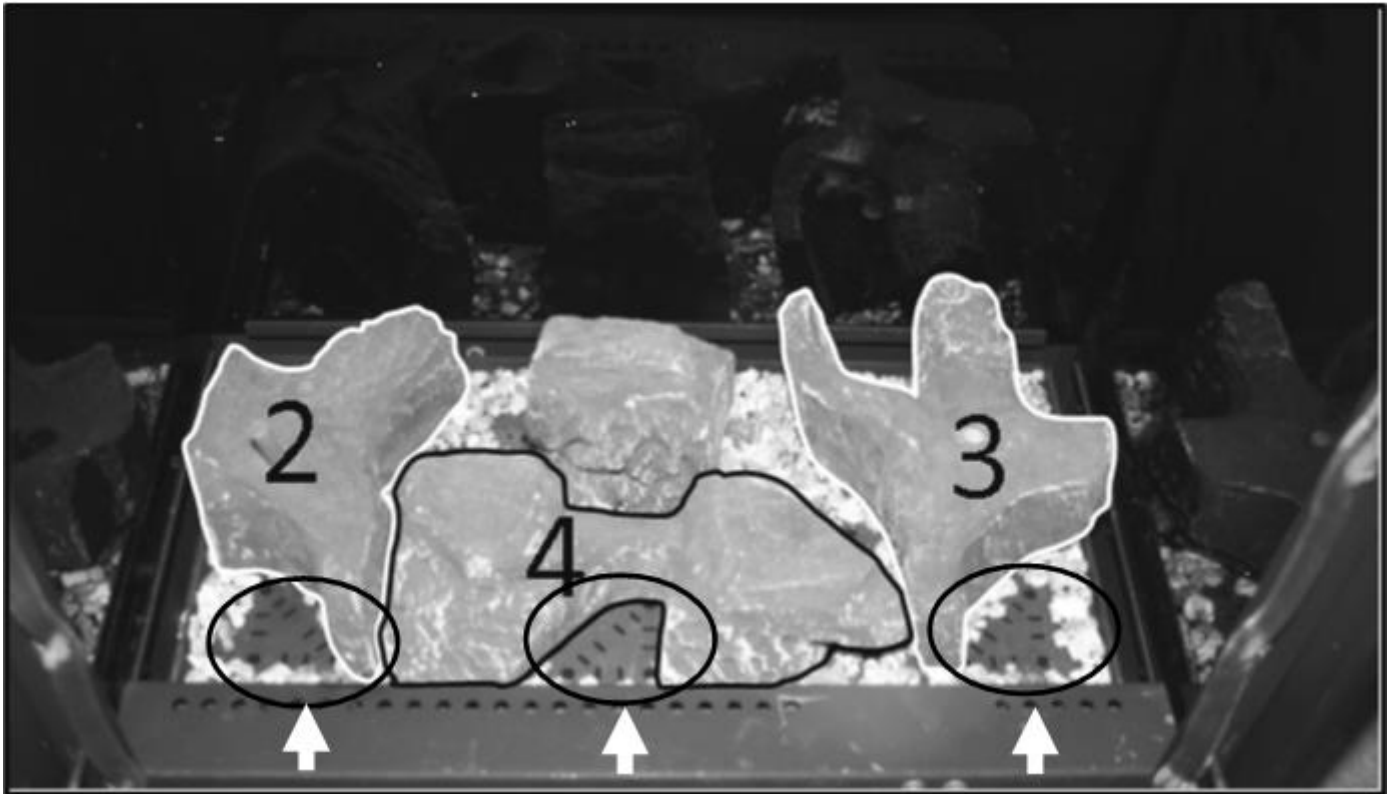

Place the other 3 base shapes as shown above. Place Embaglow in the 3 areas indicated.

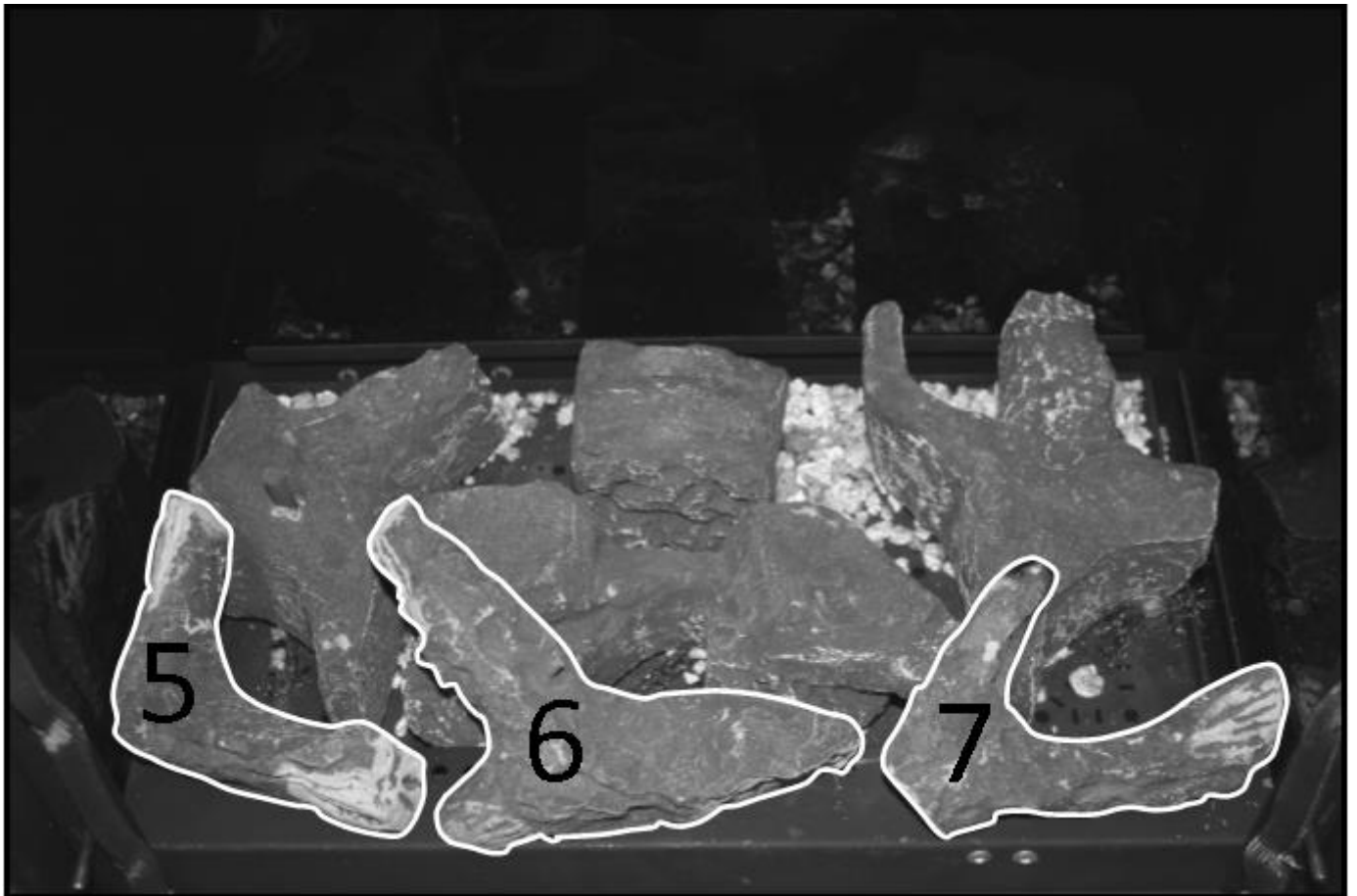

Place the front row of logs as shown above.

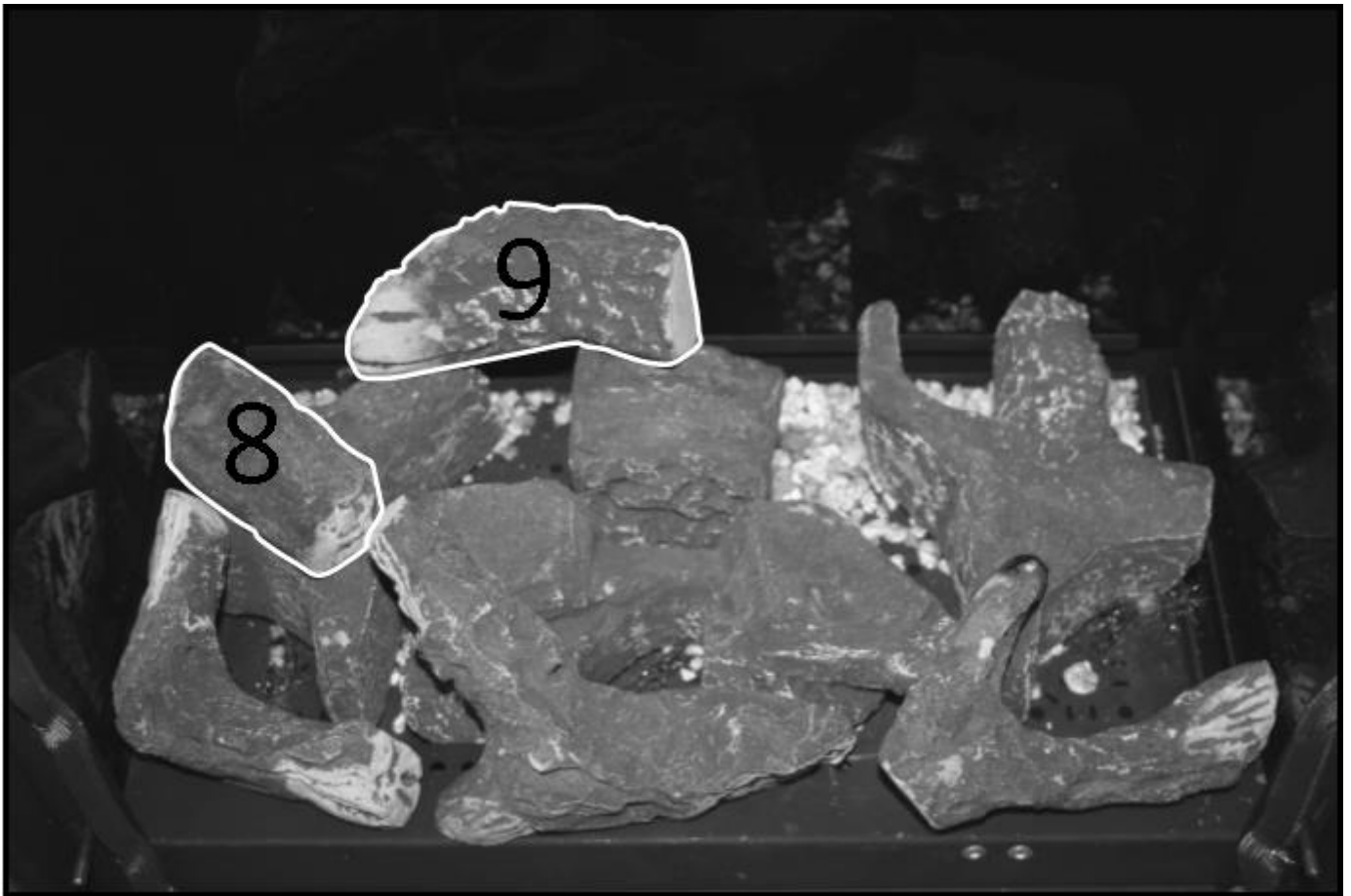

Place logs 8 & 9 as shown above.

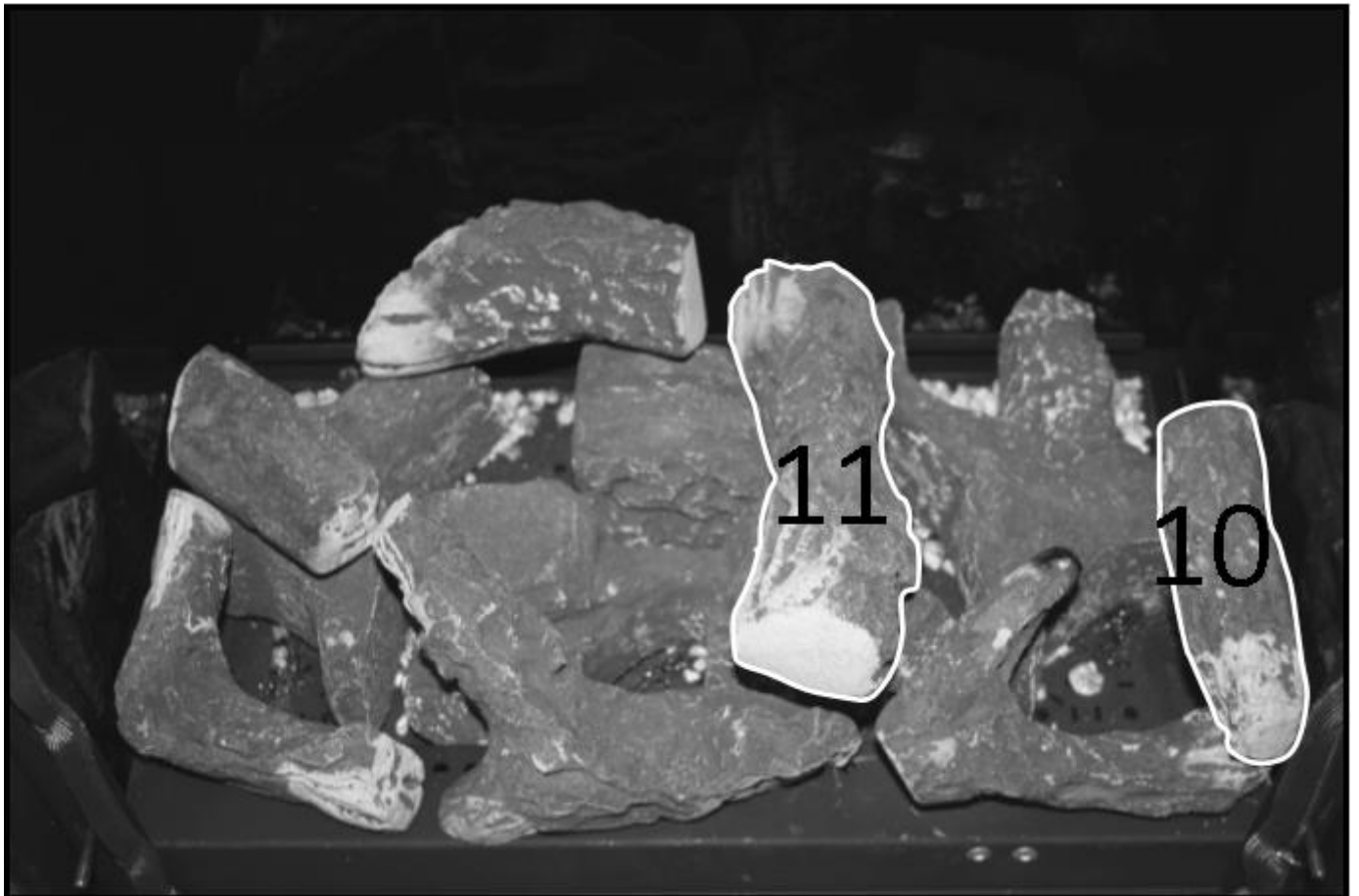

Place logs 10 & 11 as shown above

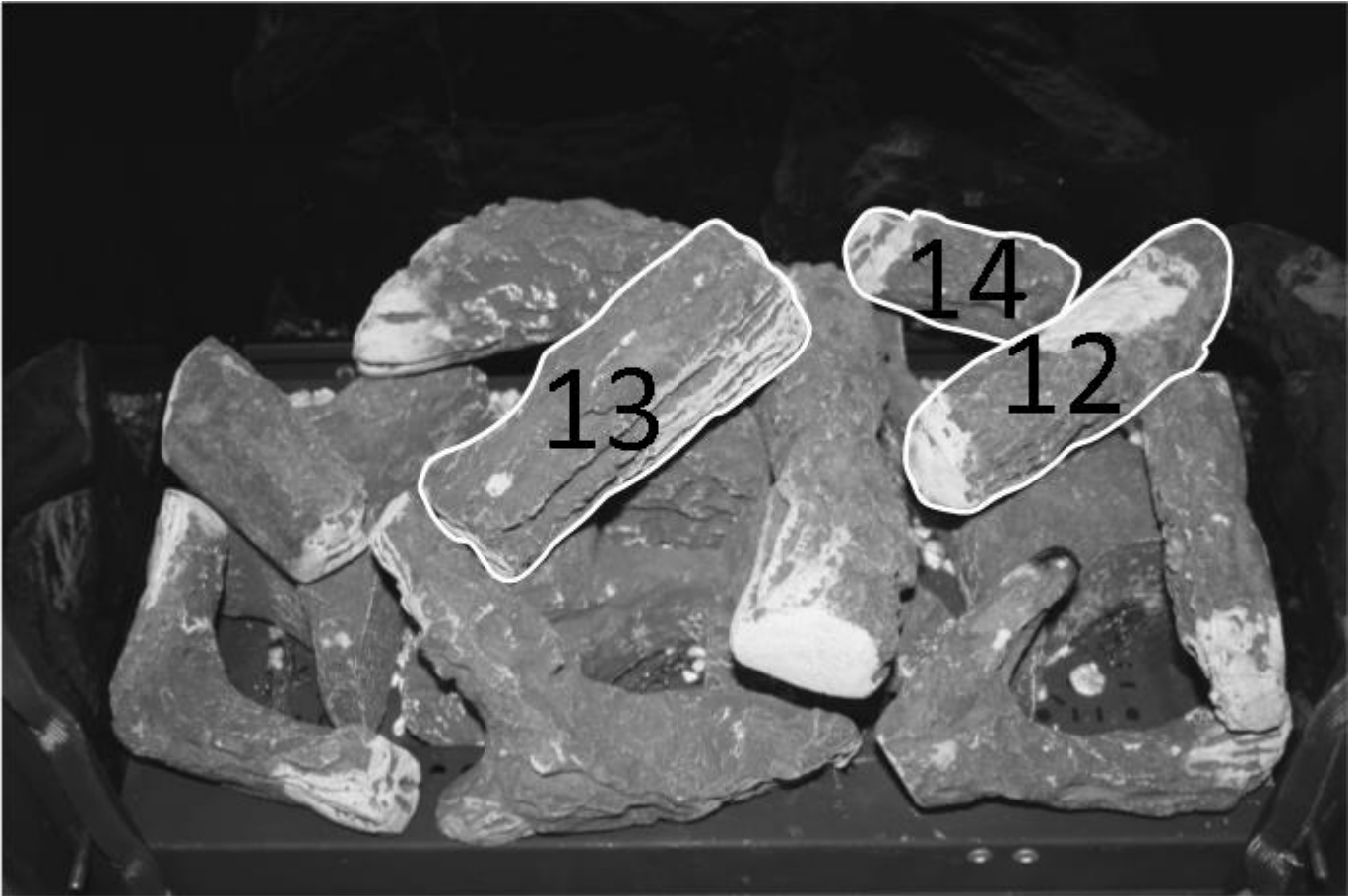

Place the final 3 log shapes as shown. Please ensure that the flat edge of log 14 is touching the rear glass panel.

SECTION FIVE General Points (Users Instructions)

Like all appliances incorporating an aerated burner a low frequency noise may be heard, particularly on the low setting, this is quite normal and does not affect the operation of the appliance.

It is advised that a competent person service the EDGE BF fire annually. The fire is more likely to provide trouble-free operation.

Dulling and slight discoloration inside the firebox will occur adding to the realism of the appliance. This is normal.

It is important that: -

- The flue is checked annually to ensure clearance of combustion products.
- Any debris from the flue should be removed. The fire should be allowed to cool before it is removed.
- The fire must not be used if the glass panel is missing or damaged.
- The data badge is located on the back of the door.

The only user removable parts are: -

- Top plate.
- Door assembly.
- Glass panel.
- Refractory Fuel bed Components.

SECTION SIX Appliance Data (Installation Instructions)

Fire Box dimensions:.....	Height 595mm
	Width 426mm
Forward Projection:.....	356mm
Weight:.....	40 kg
Rear Exit Flue Length **.....	100mm (minimum) to 600mm (maximum)
Top Exit Flue.....	0.5M (minimum) to 8M (maximum)
Pressure Test Point Location:.....	Gas inlet elbow
Gas Connection:.....	8.0mm O/D, tube.
Data Badge Location:.....	On the back of the door.

Edge BF	Natural Gas (G20) Version	LPG (G31) Version
Category of appliance	C _{II}	C _{II}
NO _x Class	4	5
Efficiency Class	1	1
Gas Category	I _{2H}	I _{3P}
Gas Type	G20 Natural Gas	G31 LPG
Gas Pressure +/- 1.0mbar	20 mbar	37 mbar
Gas Input (Max)	5.9 KW Gross	4.7 KW Gross
(Min)	3.8 kW Gross	3.2 KW Gross
Injectors size	Mk 400	Mk 116

Edge 3s BF	Natural Gas (G20) Version
Category of appliance	C _{II}
NO _x Class	4
Efficiency Class	1
Gas Category	I _{2H}
Gas Type	G20 Natural Gas
Gas Pressure +/- 1.0mbar	20 mbar
(Min)	3.8 kW Gross
Injectors size	Mk 400

NOTE: The efficiency of this appliance has been measured as specified in BS EN 613:2001 and the result is 82.2% for natural gas and 87.1% for LPG. The gross calorific value of the fuel has been used for this efficiency calculation. GasTec have certified the test data from which it has been calculated. The efficiency value may be used in the UK Government's Standard Assessment Procedure (SAP) for energy rating of dwellings.

** No bends or joined flue pipes should be used in the flue system with the standard rear exit flue with snorkel terminal.

Appliance Dimensions

EDGE BF

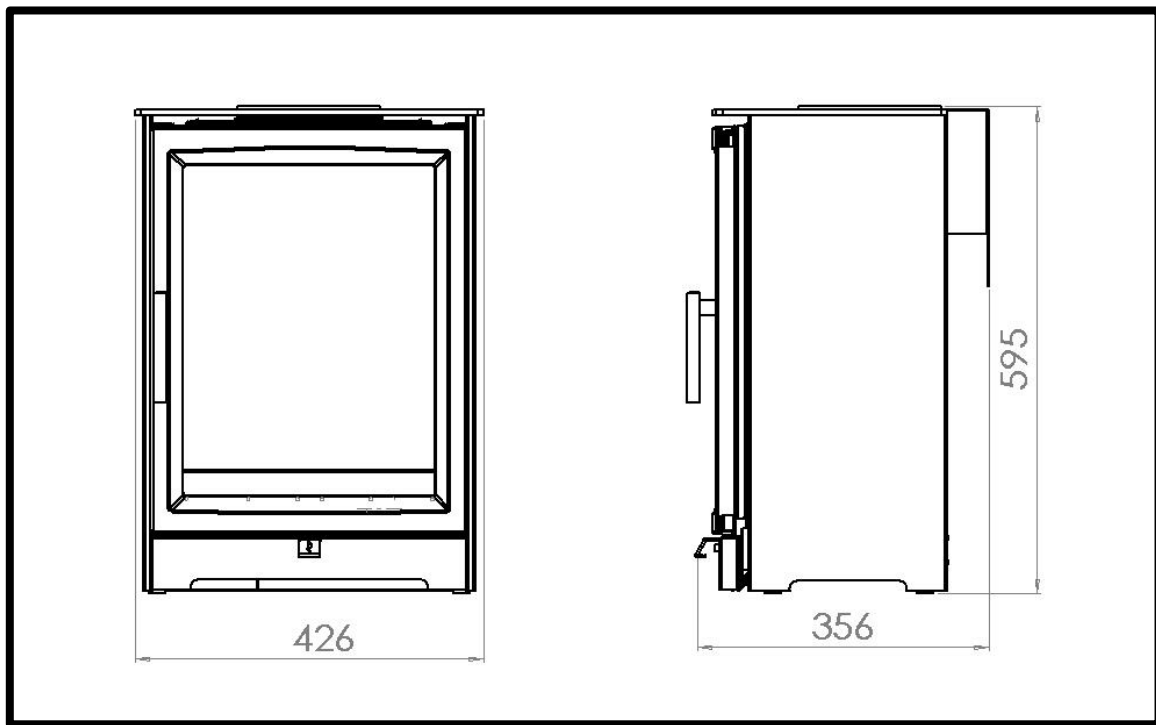

EDGE 3s BF

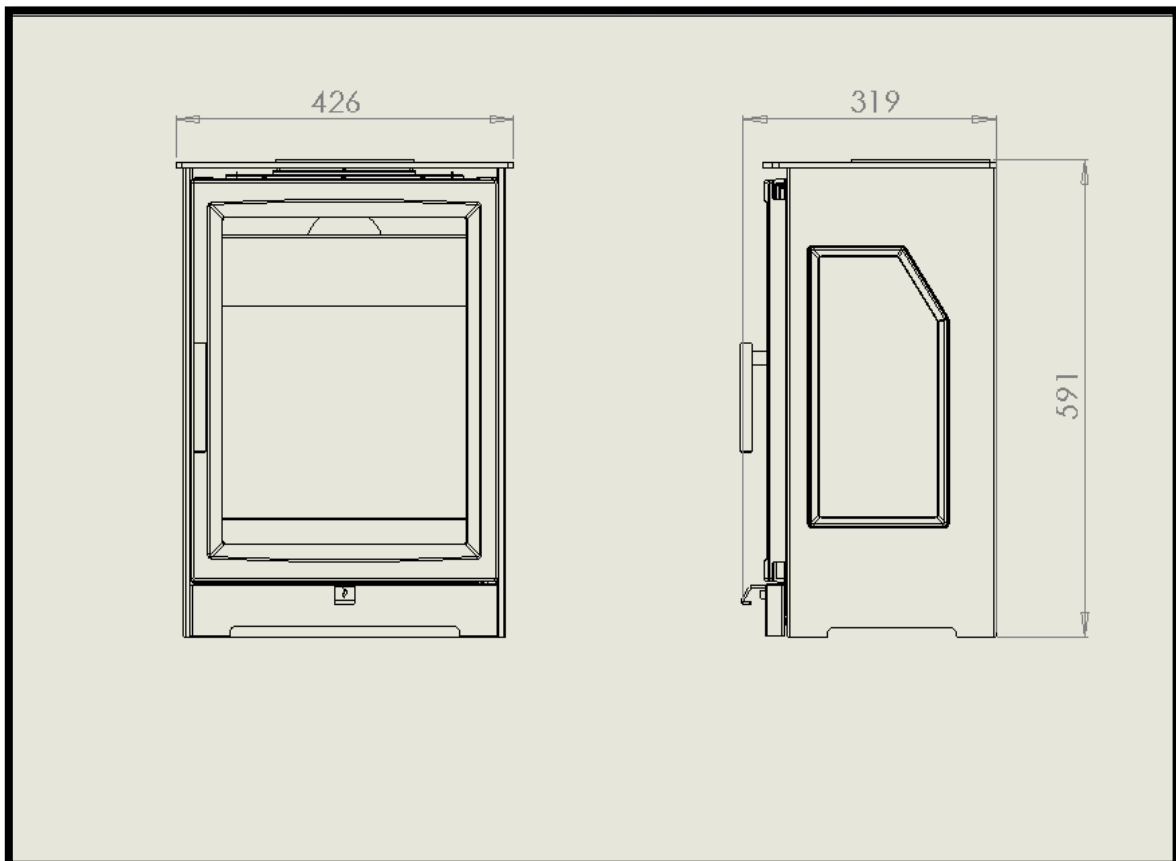

When unpacking the appliance please check the following items are included:

Fuel Bed	Owner Manual
Handset	Transformer
Top blanking plate	Front Cover grille
Flue spigots	

SECTION SEVEN Regulations and Warnings (Installation Instructions)

- This appliance must only be installed in Great Britain.
- The appliance is available in natural gas or LPG.
- This appliance must be installed on a suitable outside wall.
- No special ventilation bricks or vents are required into the room containing the appliance. In GB (Great Britain)

It is the law that all gas appliances must be installed by a competent person; i.e. a GAS SAFE registered installer, in accordance with the current Gas Safety (Installation and Use) Regulations (as amended), all relevant parts of the local and national building regulations and all relevant recommendations of the current British Standards. Failure to do so could lead to prosecution.

The following are the relevant codes of practice and British Standards: -

B.S. 5871 PART 2

B.S. 5440 PART 1

B.S. 6891

B.S. 1945

Note:- This appliance must be installed to current versions of the above standards and include any relevant amendments.

The Building Regulations issued by The Department of the Environment.

The Building Standards (Scotland) (Consolidated) Regulations issued by The Scottish Development Office.

WARNINGS

- As this appliance has components, which get very hot as with all such fires, it is recommended that a fireguard should be used for the protection of children, the elderly, or the infirm. Fireguards should conform to B.S.6539 (1984) (Fireguards for use with solid fuel appliances).
- During initial use, an odour may be evident. This will soon disappear if the fire is run on its maximum setting for a few hours.
- Care must be taken to prevent any damage being caused to surrounding soft furnishing or decoration, e.g. wall coverings may become discoloured if placed too close to the appliance.

Note: A non-combustible hearth must be provided beneath the appliance and must project forwards by 100mm all around the appliance base. The hearth must be level and have a minimum thickness of 50mm and must have a clearly defined edge (change of level) to discourage placing of any combustible materials on or partially over it. Minimum hearth size is 626mm wide x 456mm deep x 12mm high.

SECTION EIGHT Siting the Appliance (Installation Instructions)

General Requirements

Rear Exit

- The flue and air duct length must be between 100mm to 600mm. The flue and air duct must not have any bends. The 600mm length of flue assembly can be cut down as required.
- The flue outlet must terminate on a suitable outside wall.
- The minimum flue terminal clearances, which must be maintained are as shown below.

Top Flue Up & Out

- The flue air duct length must be between 0.5metre & 8metres. The flue air duct will require a 90 degree bend plus terminal to a maximum length of 8 metre.
- The outlet must terminate on a suitable outside wall.
- The minimum flue terminal clearance, which must be maintained are as shown below.

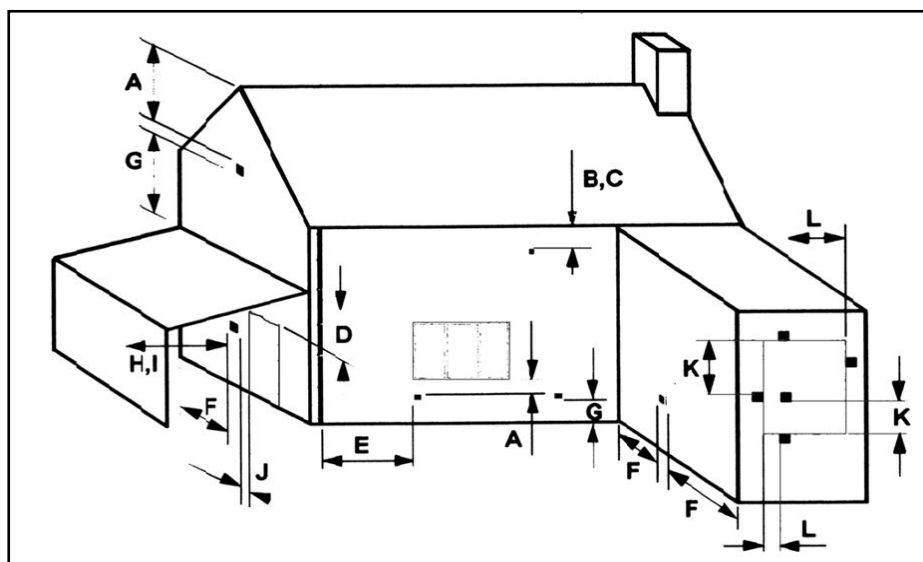

A	Directly below an openable window or other opening. E.g. air brick.....	300mm
B	Below gutters, soil pipes or drain pipes.....	300mm
C	Below eaves.....	300mm
D	Below balconies or carport roofs.....	600mm
E	From vertical drain and soil pipes.....	75mm
F	From internal and external corners.....	300mm
G	Above ground, roof or balcony level.....	370mm
H	From a surface facing the terminal.....	600mm
I	From a terminal facing the terminal.....	1200mm
J	From an opening in a car port into a dwelling e.g. door, window, etc.....	1200mm
K	Vertically from a terminal on the same wall.....	1500mm
L	Horizontally from a terminal on the same wall.....	300mm

(When installing in a timber framed dwelling reference must be made to the specific installation requirements stated in **Section 10 Installing the Appliance in Timber Framed Dwelling**).

This appliance can be flued using two methods.

- 1, Rear vented using a standard flue air duct assembly up to 600mm.
- 2, Top vent which will involve the changing over of the spigot position from rear to top, plus fitting an additional restrictor plate when flue length exceeds 2metres on a vertical rise.

SECTION NINE Preparing the Appliance for Installation

- Carefully unpack the appliance from the carton and check the contents.
- Remove the top plate. Lift away the door, which hooks over the lip of the combustion chamber and remove the ash pan cover. Place these to one side.
- Loosen the three bottom clamp flange nuts but **DO NOT REMOVE**.
- Remove the remaining flange nuts from around the glass panel and lift away the three clamps holding the glass.
- With extreme care lift away the glass panel and put to one side in a safe place.
- Change spigot positions and fit the restrictor plate (if required) if installing with the top outlet flue system.
- The appliance is now ready for installation.

Optional stand

The Edge Bf product can be fitted stove body only or with one the following options.

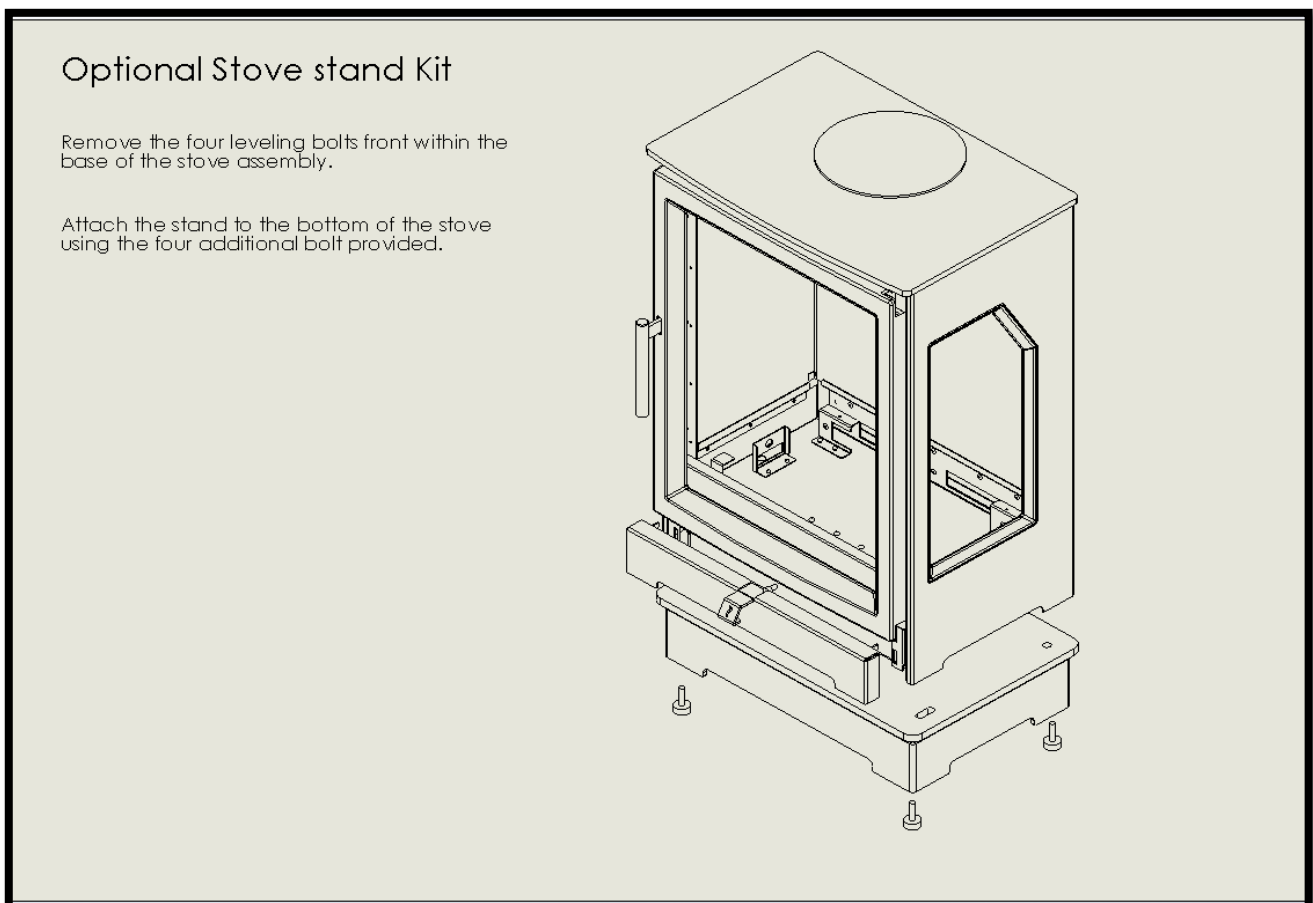

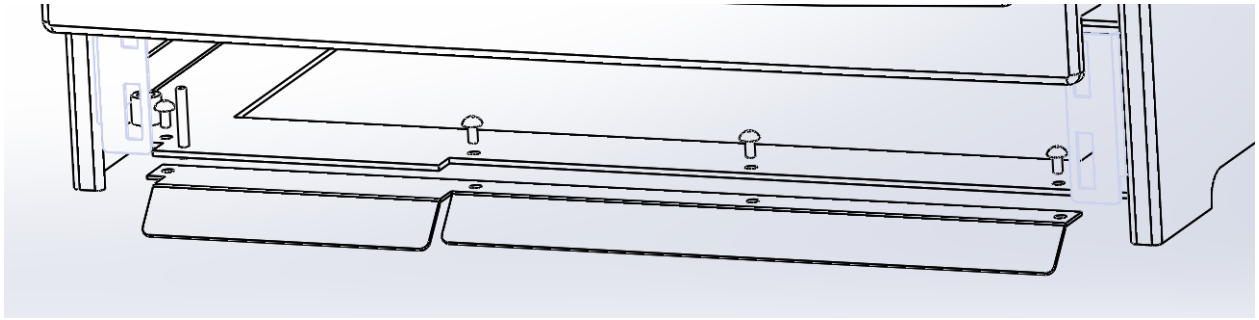

Front air deflector plate which is attached via the 4 screws and nuts needs to be removed when being fitted with the log store

Log Store Option

The control cover with the appliance is not required.

Remove the four stability bolts located within the base of the stove.

The cast door should be removed from the log store assembly for access.

Place the stove assembly within the guides on the top face of the store.

Pass the four bolts from the kit through the top lid of the log store and fix using the stability nuts located within the base of the stove.

A technical line drawing showing a stove being inserted into a log store. The stove is positioned on top of the log store's lid. The log store has a front door that is open. Two labels with arrows point to the 'Log Store Control Cover' and the 'Cast Front Door'. The stove has a chimney pipe on top.

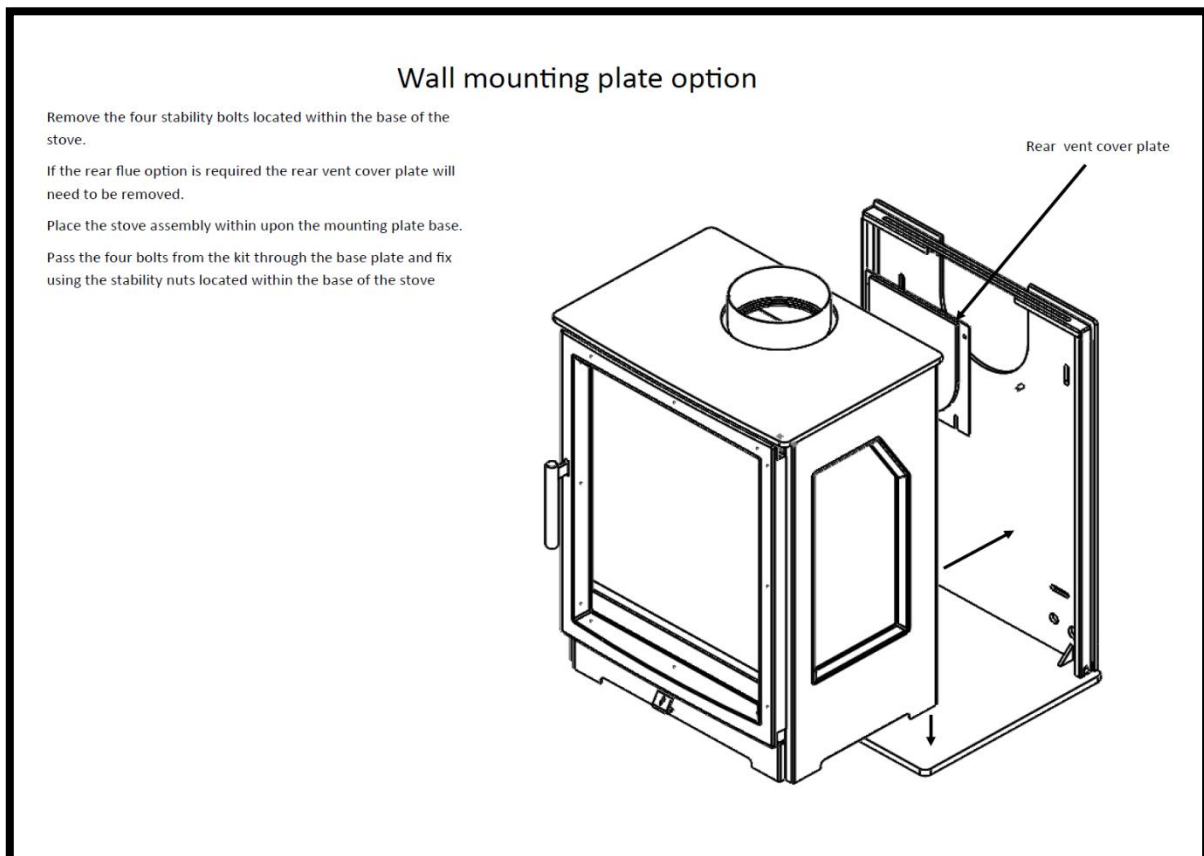

Please note suitable wall plugs fixings and screws must be used to support the weight of both mounting bracket / stove.

Non-combustible hearth requirements

The appliance must be fitted with a hearth that is 12mm high and projects 100mm to the front and sides. Minimum size of 626mm wide x 456mm deep x 12mm high.

Distances from Non-combustible materials:

The stove can be recessed in a suitable sized non-combustible fireplace but a permanent free air gap of at least 50mm must be left around the sides and top and at least 50 mm at the back of the stove to obtain reasonable heat output and for access to the stove for removal and maintenance.

Minimum clearances required to combustible material (Note the shelf clearances are for rear vent installation only)

Inglenook installation with a combustible shelf

A- Distance from the appliance top
to a combustible shelf.

Shelf depth 3" (75mm) A- Distance 265mm

Shelf depth 6" (150mm) A- Distance 415mm

The flue cover bracket must
be installed to maintain a
50mm gap any rear combustible
surface.

Minimum hearth height 12mm

Minimum distance from the front
face of the stove to the edge of
the hearth 100mm.

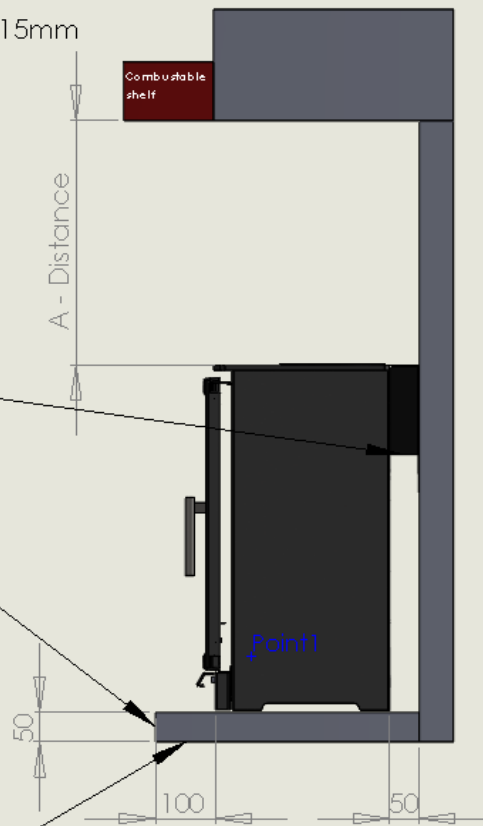

Wall mounting kit minimum combustible clearances

- A - Minimum clearance from a combustible floor covering 150mm.
- B - Minimum clearance to the underside of a combustible shelf 350mm. (Shelf projection for 150mm max).
- C - Minimum clearance to a combustible side wall 350mm.



Stove stand minimum combustible clearances

A- Minimum clearance to the underside of a combustible shelf 350mm. (Shelf projection for 150mm max).

B- Minimum clearance to a combustible side wall 350mm.



SECTION TEN Installing the Appliance (Installation Instructions)

INSTALLING THE APPLIANCE ONTO A CAVITY WALL. (When installing in a timber framed dwelling reference must be made to the specific installation requirements stated later in this **Section 'Installing The Appliance In Timber Framed Dwelling'**).

- Ensure it is a suitable outside wall constructed of non-combustible materials and that the flue position meets the requirements previously described in **Section 8**.
- Mark a horizontal line on the wall at the intended hearth surface or appliance base height.
- Mark a vertical line on the wall at the intended centre of the appliance up from the horizontal line for a height of 595mm.

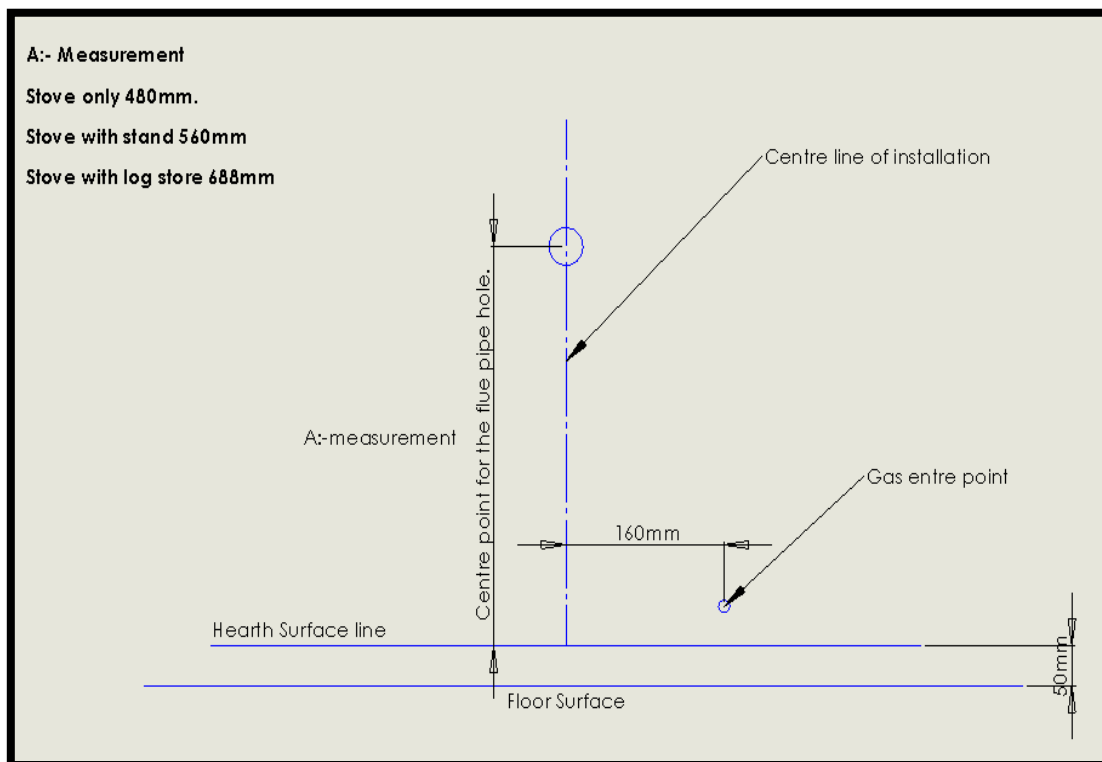

- Mark a short horizontal line so it crosses the centre line at 483mm above hearth level line. This is the centre point for the flue pipe hole.
- Using a long masonry drill, make a pilot hole completely through the wall. Ensure the hole is drilled accurately at the centre and square to the wall both horizontally and vertically at the cross point previously marked.
- Using 150mm (6") core drill cut a hole following the pilot hole. Drill from the outside through to the cavity to give a good finish on the outside.
- Remove any cavity insulation from the cut-out opening and for a further 100mm into the cavity gap each side and above.
- Pack "Rockwool" around the sides and top of the opening into the cavity for a depth of 100mm.
- Position the gas supply (see connecting the gas supply later in this manual), taking account of the relative gas regulations regarding a gas pipe in a cavity (sleeving and sealing etc). Note the gas feed must be fitted with the restrictor elbow supplied.
- Lay the hearth if required so that it is positioned correctly to the horizontal line.

- Position and fix the flue cover bracket centrally to the core drilled hole. This will space the appliance 50mm from the rear wall or back panel.
- Offer the appliance into position and mark through the gas pipe entry hole (see connecting the gas supply section).
- Pass a tape measure through the core-drilled hole and record the distance from the inner and outer spigots to the surface of the outside wall. Include the length of the spigots themselves in this measurement for the engagement allowance.
- Mark the outer pipe measuring from the terminal which will end up nearest the wall. DO NOT cut right through at this stage, as the inner tube needs to be LONGER than the outside one. Failure to do this correctly could lead to scrapping of the flue tube and having to order another to ensure safe operation. Cut the outer tube to length, ensuring it is cut square and the edges are free from any rough edges.
- Now measure from the same position for the inside pipe dimension and cut to length ensuring it is cut square and the edges are free from any rough edges.
- Apply flue seal or fire cement to the inside edges of both flue pipes and insert through the hole and onto the fire spigots.
- Drill the four fixing holes through the holes in the flange of the terminal and fix back using plug and screws.
- If the flue outlet is fitted below 2m from the floor or a balcony level then the flue terminal guard must be fitted.
- Complete the gas connection (see connecting the gas supply later in this manual).

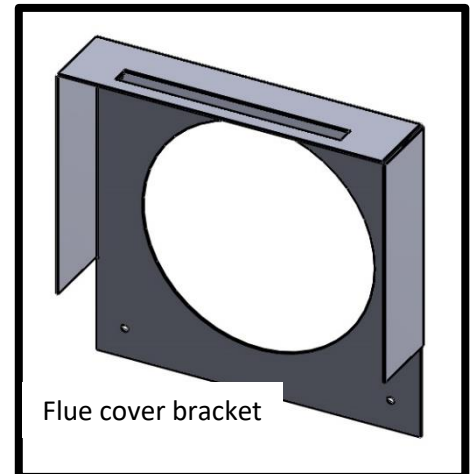

INSTALLING THE APPLIANCE INTO DEEP REBATED FIRE SURROUND OR INGLENOK CHIMNEY BREAST. (When installing in a timber framed dwelling reference must be made to the specific installation requirements stated later in this Section 'Installing The Appliance In Timber Framed Dwelling').

- Ensure there is a suitable outside wall constructed of non-combustible materials and that the flue position meets the requirements previously described.
- Mark a horizontal line on the wall at the intended hearth surface or appliance base height. If required the skirting board must be cut away from behind the fire.
- Mark a vertical line on the wall at the intended centre of the appliance up from the horizontal line for a height of 595mm.
- Mark a short horizontal line so it crosses the centre line at 480 mm above hearth level line. This is the centre point for the flue duct hole.
- Using a long masonry drill, make a pilot hole completely through the wall. Ensure the hole is drilled accurately at the centre and square to the wall both horizontally and vertically at the cross point previously marked.
- Using 150mm (6") core drill cut the hole following the pilot hole. Drill from the outside of the dwelling through to the cavity, and from the inside through to the cavity for best results.
- Remove any combustible material that may be present if the rear of the appliance is contacting the wall i.e. ensure no battens etc., behind dry lining in the area shown around the flue and top of firebox. Always remove a 25mm (1") area around the flue if plasterboard etc is present anyway.
- Lay the base so that it is positioned correctly to the horizontal line.
- Temporarily position and fix the back panel and deep surround, or construct a dummy chimneybreast as required, using **NON-COMBUSTIBLE MATERIALS ONLY**.
- Offer the appliance into position and mark through the gas pipe entry hole (see connecting the gas supply section).

- Pass a tape measure through the core-drilled hole and record the distance from the inner and outer spigots to the surface of the outside wall. Include the length of the spigots themselves in this measurement for the engagement allowance.
- Mark the outer pipe measuring from the terminal which will end up nearest the wall. DO NOT cut right through at this stage, as the inner tube needs to be LONGER than the outside one. Failure to do this correctly could lead to scrapping of the flue tube and having to order another to ensure safe operation. Cut the outer tube to length, ensuring it is cut square and the edges are free from any rough edges.
- Now measure from the same position for the inside pipe dimension and cut to length ensuring it is cut square and the edges are free from any rough edges.
- Apply flue seal or fire cement to the inside edges of both flue pipes and insert through the hole and onto the fire spigots.
- Drill the four fixing holes through the holes in the flange of the terminal and fix back using plug and screws.
- If the flue outlet is fitted below 2m from the floor or a balcony then the flue terminal guard must be fitted.
- Complete the gas connection (see connecting the gas supply later in this manual).

TIMBER FRAMED DWELLING

This method allows for installation in timber frame buildings. Where removal of any part of the inner timber leaf of the wall is involved the structural integrity of the wall must be maintained and the advice of your local Building Control Department should be sought. If the property is under N.H.B.C. cover, it is advised that their advice should also be sought. Reference should be made to the British Gas Publication DM2 "Guide For Gas Installations In Timber Frame Housing" or Gas Safe "Gas installations in Timber Frame Buildings" ISBN1-902632-30-3

Special attention must be paid to the location of the studwork frames of the inner leaf and the appliance positioned accordingly. Electrical cables and pipe work that run within the inner timber leaf must also be located and taken into account when positioning the appliance.

The following methods of installation may be adapted for use in timber frame buildings providing extra care is taken to protect combustible materials from contact with hot surfaces or build up of heat.

- An insulation material (20mm "Superlux" or equivalent) must protect all combustible surfaces (including plasterboard) situated within and behind the appliance.
- Where the flue duct passes through the inner timber leaf a concentric hole 200 mm diameter should be cut around the duct pipe, allowing a minimum 25mm air gap all round the duct pipe. A non-combustible sleeve 200mm diameter must be fitted to these clearance holes. Sheet metal is usually suitable.
- To ensure that any condensation formed on the duct pipe does not drip on to the inner wall a length of galvanised wire must wrapped around the flue pipe and secured in position by twisting the ends together. Ensure that the twisted ends are located at the bottom of the pipe and the wire is centrally located within the cavity.
- The vapour barrier on the back of the inner timber leaf should be carefully cut and fixed to prevent ingress of damp into the plasterboard layer.

TOP FLUE UP & OUT

A top flue exit kit will be required (Part Number A-0803) consisting the following

- 1 off Restrictor plate. (Only to be fitted when vertical runs exceed 2 metres).
- 1 off Horizontal Terminal.
- 1 off 90 degree Elbow.
- 1 off 500mm Flue Pipe.
- 1 off Appliance connector.
- 1 off Decorative spigot cover collar



This decorative part is in with the flue terminal and is used to cover up the connection join between the flue spigot and the flue adapter



To fit the flue cover collar first fit the flue adapter and then slide the collar over the adapter to cover up the join as shown in the image above

- Additional Flue lengths will be required. (See Optional Extra Flue Length Chart for Details).
- Decide on the terminal position and measure the height from the top of the appliance to the centre of the required hole. For the minimum and maximum flue dimensions. (Please see diagram below for details)
- Depending on the height, the additional restrictor plate will need to be fitted (See chart below for details).

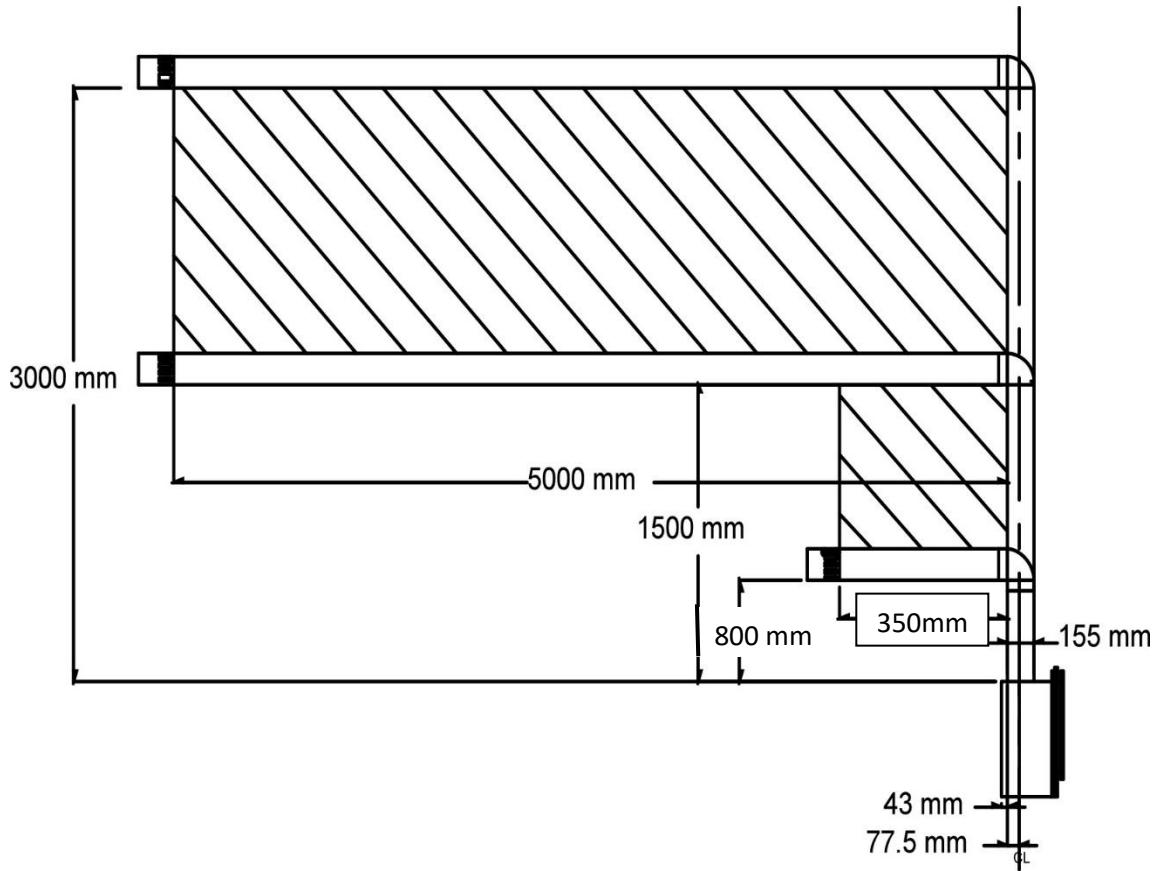

Vertical Height mm	Restrictor Plate Required
500	0
1000	0
1500	0
2000	1
2500	1
3000	1

Optional flue lengths

Addition Flue Length	Part Number
500mm Flue Length	8107
1000mm Flue Length	8108
Support Brackets	8117

SECTION ELEVEN connecting the gas supply (Installation Instructions)

GAS SUPPLY ROUTING :-

Use rigid or semi – rigid tube to connect the supply. Determine the gas supply pipe route to the appliance before installing the Stove.

Check the gas run to assess that the gas supply is capable of providing the required amount of gas and is in accordance with the rules in force.

Soft copper pipe can be used to install the appliance. Soldered joints can be used only externally of the appliance.

The appliance is supplied with a factory fitted isolation device to allow for an 8mm copper connection. No further isolation point is required.

The new gas line must be purged of any debris, prior to final connection to the appliance.

Gas inlet isolation device is located on bottom right hand side of the fire box, the gas supply entry point is positioned at the rear bottom on right hand side. The gas inlet isolation device must be angled to allow access to the grub screw and gas test nipple.

POWER LEAD ROUTING

The power supply for this appliance is provided via AC power adaptor 230 VAC. The main cable terminates the rear Right hand side of the fire box. The length of the cable provided with the appliance is 1.65 metres. Care must be taken when siting the fire box not to trap the exposed main cable within the builders opening.

Note: the power cable link to the transformer must be accessible for repairing handset and use with the battery holder

The cable can be routed using the following two methods,

Method 1

Passing the cable through the side of the chimney breast. It is good practice to run the cable within a sleeve of at least 15mm internal diameter, sealing the sleeve using a suitable sealant at the point the sleeve / cable terminates the chimney masonry.

Method 2

Remove a channel out of the outer skin of the Dry / wet plaster of the chimney breast up to the main power point. Again it is good practice to run the cable within a sleeve of at least 15mm internal diameter.

With power points that exceed the 1.65 metre distance, an optional 2.0 metre extension cable is available Part No 7147.

The cable system consists of retro fitting plug sockets which offers the following options. (Please see figure 5).

The battery manual override option is a back supply in case of a power failure / power cut to the property. The battery holder and adaptor lead are provide as an optional extra. It is good practice to demonstrate the battery option to the customer during the commissioning process.

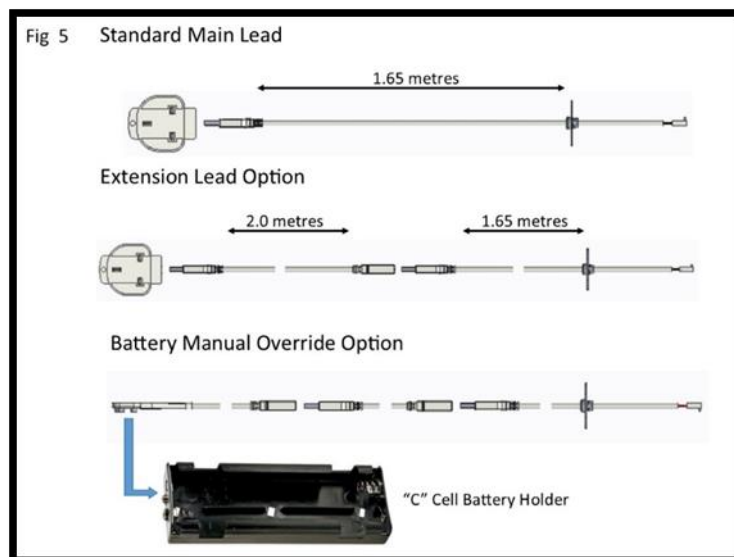

CHECKING GAS SOUNDNESS

Checking gas soundness and running pressure.

Turn on the supply to the appliance and check for tightness in accordance with the current codes of practice.

Turn off the gas supply at the external isolation valve.

Remove the pressure test point screw from the inlet elbow and connect the pressure gauge.

Turn on the gas to the appliance at the isolation valve.

Light the appliance as described in the user instruction section 2. Operating the appliance.

Check the inlet pressure is 20 mbar +/- 1.0 mbar for natural gas or 37 mbar +/-1.0 mbar for LPG with other appliances running.

Turn off gas supply, at the isolation valve. Disconnect the pressure gauge and replace the pressure test point screw.

Turn on the appliance and check the pressure test point for tightness with detection fluid.

SECTION TWELVE Checking Operation of Fire (Installation Instructions)

LAY FUEL BED

Important: -

Refer to the 'Health & Safety Notice located on page 5 of this booklet before laying or replacing any refractory material.

In the event of replacing fuel bed components please use only the specified number of components as illustrated. Only use fuel bed component provided for this appliance. In the interest of safety and efficiency of your appliance when replacing the fuel bed it is essential that the existing fuel bed be removed and the new components are replaced correctly as a complete set.

Lay Log fuel bed as described under Users Section.

Warning:

It is important that the fuel bed components are positioned as shown in these instructions.

If the fuel bed components are not positioned correctly this may result in damage to the glass.

Once fuel bed is fitted refit the glass

Locate the glass panel within the bottom-retaining bracket and push back against the seals. (Please see Fig 11).

Position the top and side fixing brackets over the edges of the glass panel and slide over the M4 studs.

Refit the nine M4 nuts previously removed and tighten the glass fixings using the nut runner provided with the appliance.

ADVISE CUSTOMER THAT:

- The glass front of this fire acts as a dress guard, conforming to BS 1945 (1997) and satisfies the heating appliance regulations (1991) however; a fireguard conforming to BS6539 (1997) must be used to protect young children, the elderly, or infirm.
- The curing effect of heating the coals and other refractory components will cause an initial odour. This is due to the starch used in the manufacturing process and is non-toxic.
- Any debris should be cleaned from the appliance. A vacuum cleaner can be used but only after all the loose log shapes and vermiculite has been removed.
- The appliance should be serviced annually by a competent person in accordance with these instructions.
- Demonstrate the lighting and extinguishing procedures to the user. Refer to the user section of this booklet.

Hand these instructions over to the user.

SECTION THIRTEEN Maintenance (Maintenance Instructions)

GENERAL

- Servicing should be carried out annually by a competent person such as a Gas Safe-registered person in accordance with the relevant regulations, to ensure the safe and correct operation of the appliance.
- Before commencing any service or replacement of parts, turn off the gas supply to the fire. After servicing check for gas soundness.
- When ordering spare parts please quote appliance name and serial number, these can be found on the data badge, which is located on the back of the door.
- If soot has accumulated checks to establish cause rectify and clean flue accordingly.

Replacement of the burner Assembly

Remove the glass panel as described on page 8 of the user instruction section.

Remove the Loose shapes.

Undo the three fixing screws retaining the burner assembly with the carrier.

Lift the burner clear of the silencer and injector tip.

Clean or replace the burner assembly.

Re-assemble in reverse order.

Replacement of the injectors

Follow the sequence to remove the burner.

Unscrew the locking nut holding the injector to the bracket.

Remove the two screw retaining the injector bracket to the appliance base and lift away from the injector.

Remove injectors from assembly. Clean or replace injector.

Re-assemble in reverse order ensuring the injector is straight.

Replacement of the gas valve

Remove the burner assembly and injector as described above.

Disconnect the pilot feed pipe from the valve and pilot assembly.

Remove the three valve bracket retaining screw from the base of the chamber.

Rotate the gas valve complete with bracket about the injector pipe.

Disconnect the thermocouple from the rear of the gas valve.

Undo the two compression nuts securing the pipes to the gas valve and remove the two M4 nuts fixing the valve and earth lead to the valve mounting bracket.

Clean, service or replace the gas valve.

Re-assemble in the reverse order.

Turn on the gas supply, check for soundness and re-commission the appliance.

Replacement of the Electronic Control Unit (ECU)

Undo the one M3 nut retaining the ECU unit and remove the connection bracket.

Disconnect the power lead from the (ECU)

Unplug the connections from the ECU board.

Re-assemble in reverse order.

Replacement Handset

Follow the guide stipulated on page 7 of the users instructions “Changing the handset batteries” to load the batteries into the new handset.

Re-Pairing the handset or ECU unit

When replacement handset or ECU the two items will need to be re-paired using the following procedure.

Start the pairing process with the power to the appliance turned off.

Make sure that the remote handset has batteries installed then turn the power on to the appliance on.

Within 30 seconds of power on, press any button on the remote handset.



The LED on the handset will start to flash quickly indicating the pairing process has started. If successful pairing is achieved then the LED will show 5 slow flashes. If pairing fails there will be 3 long flashes.

If this happens then remove power to the appliance and repeat the pairing process.

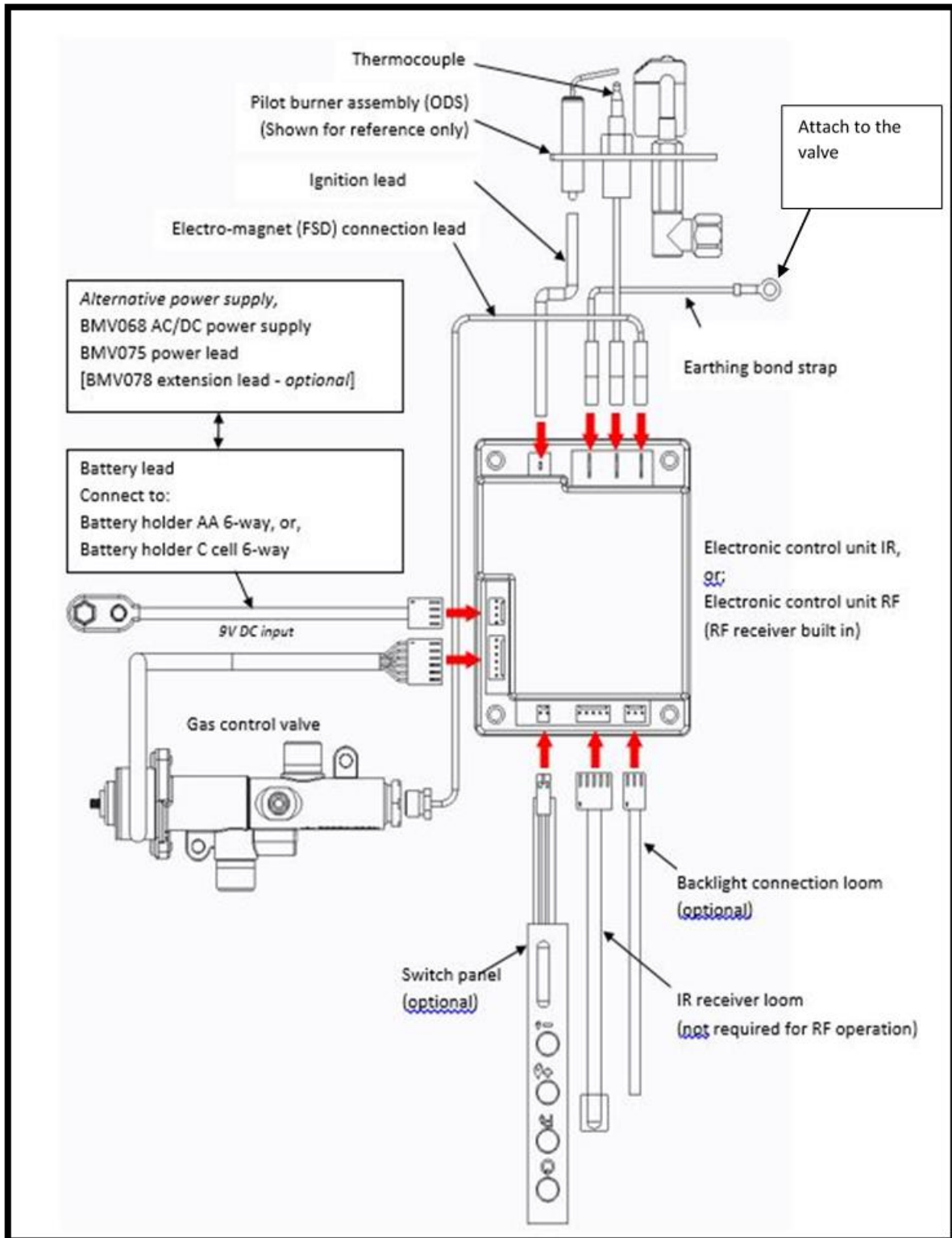
SECTION FOURTEEN Wiring Diagram (Maintenance Instructions)



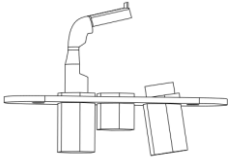
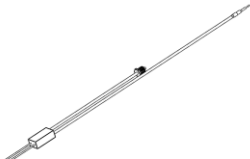
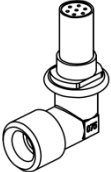
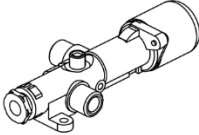
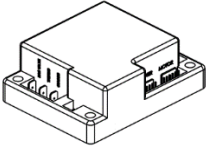

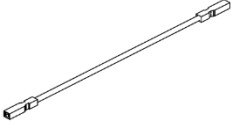
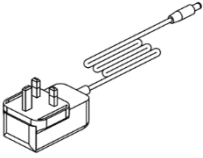
SECTION FIFTEEN Short Spares List

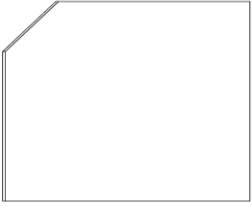
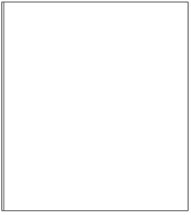
Edge BF		
Image	Description	Part number
	Pilot gasket	2110
	Pilot assembly	8674
	Thermocouple	4739
	Injector	2108
	Silencer	None fitted
	Valve	6590
	EDB	8080
	Handset	8081
	Earth lead	6593
	Ignition lead	6646
	9V transformer	7145

	Rear liner	8097
	Side glass	RH: 8098 LH: 8099
	Front glass	8100

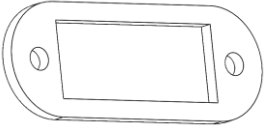
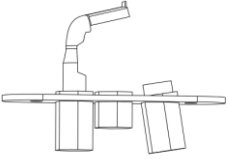
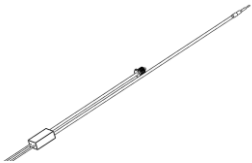
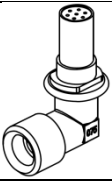
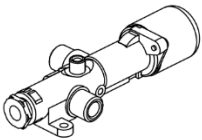
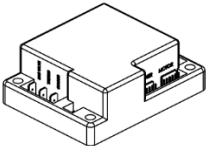
Edge 3's BF

Image	Description	Part number
	Pilot gasket	2110
	Pilot assembly	8674
	Thermocouple	4739
	Injector	2108
	Silencer	None fitted
	Valve	6590
	EDB	8080

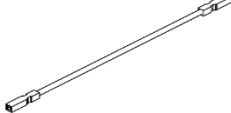
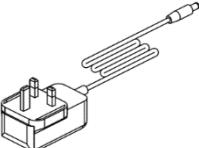
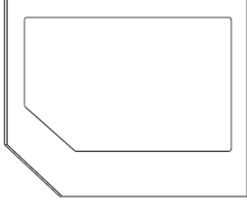
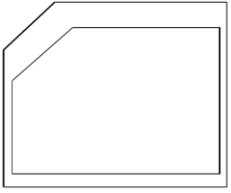
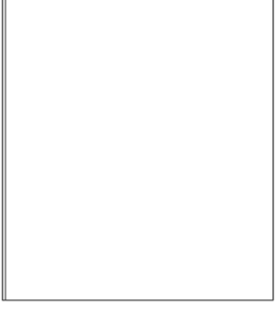
	Handset	8081
	Earth lead	6593
	Ignition lead	6646
	9V transformer	7145
	Rear liner	8532
	Side viewing glass	RH: 8530 LH: 8531
	Side glass gasket	8533
	Front glass	8100

Register your appliance online today to active your warranty



GAS FIRE COMMISSIONING CHECKLIST

This Commissioning Checklist is to be completed in full by the competent person who commissioned the gas fire as a means of demonstrating compliance with the appropriate Building Regulations and then handed to the customer to keep for future reference.

Failure to install and commission according to the manufacturer's instructions and complete this Benchmark Commissioning Checklist will invalidate the warranty. This does not affect the customer's statutory rights.

Site Requirements	Yes	N/A
Was the chimney checked to ensure it only serves one flue/fire, has no obstructions and is continuous?		
Has any debris at the base of the chimney been removed?		
For brick chimney installations is there enough depth for 12 litres of debris, or precast flues 2 litres of debris? (see instructions for debris gap details)		
Have damper and register plates been removed or locked in the fully open position ensuring correct size of flue is maintained?		
If previously used for solid fuel has the chimney been thoroughly swept?		
If the chimney is pre-cast has the inside of the flue been checked for extruded cement / sealant which must be removed?		
Has the fire place been checked for under-floor air supply which must be sealed off?		
Has the chimney been inspected prior to fitting the gas fire to ensure that it is in good condition?		
Has the structure of the chimney been checked for leakage using a smoke pellet test? (See BS5440-1 for details).		
Ventilation		
Does the installation require any additional ventilation requirements as detailed in the manufacturer's instructions?		
Hearth Requirements- where fitted		
Is the hearth constructed from non -combustible material?		
Is the hearth a minimum of 12mm thick with a minimum floor to top surface of 50mm?(BS5871) or as per manufacturer's instructions?		
Is the hearth for open fronted fires a minimum of 760mm wide and has 300mm projecting from the fire opening (BS6871) or to manufacturer's instructions?		
Mounting height (where applicable) has the fire been installed to the correct mounting height- as per manufacturer's instructions?		
Firebox and Fuel Bed		
Has the fuel bed, coals, pebbles etc. been fitted to manufacturer's instructions?		
Gas Supply		
Has an isolation tap/restrictor inlet elbow been fitted for servicing?		
Has the gas supply been thoroughly purged prior to connection to remove any debris?		
Has a gas tightness test been completed prior to breaking into the gas supply and following completion of installation?(IGEM/UP/1B)		
Record burner gas pressure reading? If only the supply pressure is available a gas rate must be undertaken.(GSIUR REG26/9C)		
Record dynamic inlet gas pressure (working pressure) reading (all gas appliances running)		
Spillage test		
Installation passes smoke match test with any extractor fans turned on (see manufacturer's instructions)		
Installation		
Has the gas fire been installed and commissioned in accordance with manufacturer's instructions?		
Has the fire been installed with the correct clearance to combustible materials, as per manufacturer's instructions?		
The operation of the appliance and controls have been demonstrated to the customer including battery replacement where applicable?		
The manufacturer's literature, including Benchmark Checklist and Service record has been explained and left with the customer?		
Has the appliance been registered with the Local Authority as detailed on the Gas Safe web site and is a legal requirement and forms part of the warranty?		
Customer's Signature: (To confirm satisfactory demonstration and receipt of manufacturer's literature)	Commissioning Engineer's Signature:	

*All installations in England and Wales must be notified to be Local Authority Building Control (LABC) either directly or through a Competent Persons Scheme. A Building Regulations Compliance Certificate will then be issued to the customer.

SERVICE RECORD

It is essential that your gas fire is serviced regularly and that the appropriate Service Interval Record is completed. Service Provider

Before completing the appropriate Service Record below, please ensure you have carried out the service as described in the manufacturer's instructions. Always use the manufacturer's specified spare part when replacing controls.

SERVICE 01	Date:
Engineer name:	
Company name:	
Telephone No:	
Gas safe register No:	
Comments:	
Signature	

SERVICE 02	Date:
Engineer name:	
Company name:	
Telephone No:	
Gas safe register No:	
Comments:	
Signature	

SERVICE 03	Date:
Engineer name:	
Company name:	
Telephone No:	
Gas safe register No:	
Comments:	
Signature	

SERVICE 04	Date:
Engineer name:	
Company name:	
Telephone No:	
Gas safe register No:	
Comments:	
Signature	

SERVICE 05	Date:
Engineer name:	
Company name:	
Telephone No:	
Gas safe register No:	
Comments:	
Signature	

Edge BF & Edge 3s BF Gas Stove

Product ID Label	A-0771 A-0826 A-0836	A-0864 A-0865	Serial No Prefix	SW TM	UF
Burner Tray / Box Assembly					
Restrictor Elbow (2189)					
Log Fuel Set 8800					
Glass Panel					
Data Badge					
Warning Label					
ID Label & Packing Labels					
Owners Book					
7MM Nut Spinner					
Batteries (AAA x 2)					
Transformer (Boxed)					
Inner and Outer Spigot with gaskets					
Door and Ash-pan, and front grille					
Flue Cover Bracket					
Embaglow					
vermiculite					
Serial Number					
Inspector					