

PARAGON FIRES

**PARAGON FOCUS RS PLUS
REMOTE**

ROOM SEALED INSET LIVE FUEL EFFECT GAS FIRE

**OWNER'S
MANUAL**

**Please read these instructions carefully before you start
using the appliance**

Keep this booklet handy for future reference

**This appliance is
for use in GREAT BRITAIN or
IRELAND only**

(2 x INJECTOR TIPS SUPPLIED WITH THIS APPLIANCE)

**5.4kw – 2.4kw INJECTOR
&
3.8kw – 2.4kw INJECTOR**

**TELFORD
SHROPSHIRE
ENGLAND**

PARAGON FOCUS RS PLUS REMOTE Instructions

CONTENTS

	PAGE
User's Instructions	3
SECTION ONE Important Information	3
Consumer Protection	3
Health and Safety Notice	3
SECTION TWO Introduction	5
SECTION THREE Operation	6
Lighting the Fire	6
Turning Off the Fire	6
SECTION FOUR Cleaning and Coal Laying	8
Cleaning Decorative Trim	8
Cleaning: Black Painted Surfaces	8
Cleaning: Glass Panel	8
Cleaning and Replacing Coals	9
SECTION FIVE Replacement Parts	13
Installation Instructions	14
SECTION SIX Appliance Data	14
SECTION SEVEN Regulations and Warnings	15
SECTION EIGHT Siting the Appliance	16
General Requirements	16
SECTION NINE Preparing the Appliance for Installation	17
SECTION TEN Install the appliance	18
Installing the Appliance into a Cavity Wall	18
Installing the Appliance into a Deep Rebated Surround or Dummy Breast	20
Installing the Appliance into a Timber Framed Dwelling	22
Connecting the Gas Supply	23
Checking Gas Soundness	23
Changing the injector	23
SECTION ELEVEN Assemble the Appliance	24
SECTION TWELVE Check Operation of Fire	25
Check Burner Pressure and General Operation	25
SECTION THIRTEEN Instruct and Advise Customer	25
Maintenance Instructions	26
SECTION FOURTEEN Maintenance Instructions	26
General	26
Replacement of Gas Control	26
Replacement of Injector	26
Replacement of the Thermocouple	27
Replacement of Pilot Injector	27
Replacement of EDB Unit	27

SECTION ONE Important Information

Consumer Protection Information

As manufacturers and suppliers of heating products, we take every care, as far as is reasonably practicable, that these products are so designed and constructed as to meet the general safety requirement when properly used and installed. To this end, our products are thoroughly tested and examined before despatch.

IMPORTANT NOTICE: Any alteration that is not approved by the appliance manufacturer could invalidate the approval of the appliance, operation of the warranty and could affect your statutory rights.

Health and Safety Notice

Important

This appliance could contain some of the materials, indicated below, that could be interpreted as being injurious to health and safety. It is the users / installers responsibility to ensure that the necessary personal protective clothing is worn when handling these materials, see below for information.

Artificial Fuels, Mineral Wool, Insulation Material, Refractory/Ceramic Fibres, Glass Yarn - *may be harmful if inhaled, may be irritating to skin, eyes, nose and throat.*

When handling *avoid inhaling and contact with skin or eyes. Use disposable gloves, facemasks and eye protection. After handling wash hands and other exposed parts. If a vacuum is used for cleaning the coals or cleaning after servicing / installation it is recommended that it be of the type fitted with a HEPA filter.*

Disposal of refractory/ceramic materials. *To keep dust to a minimum these materials should be securely wrapped in polythene and be clearly labelled 'RCF waste'. These materials are not classified as 'hazardous waste' and should be disposed of at a site licensed for the disposal of industrial waste.*

- The PARAGON FOCUS RS PLUS REMOTE is an inset room sealed decorative fuel-effect gas appliance.
- The PARAGON FOCUS RS PLUS REMOTE is available in **Natural Gas (G20 @ 20 mbar) Only**. The marking (**G20 for natural gas**) on the packaging and the data badge specify the gas for which the appliance has been factory set. **Note: These appliances should only be used on the appropriate gas specified. They are not suitable for conversion from one gas to the other.**
- This appliance **must not** be installed into a natural draught flue or chimney.
- Failure to install appliance correctly could lead to prosecution.
In GB (Great Britain), the appliance must be installed and serviced by a competent person i.e. Gas Safe-registered, in accordance with the GAS SAFETY (INSTALLATION AND USE) REGULATIONS, The Building Regulations (or The Building Regulations (Scotland) or The Building Regulations (Northern Ireland)) and The Current I.E.E. Wiring Regulations, if appropriate.
In IE (Ireland), the appliance must be installed and serviced by a competent person and installed in accordance with the current edition of I.S.813 Domestic Gas Installation, the current Building Regulations and the current ETCl rules for electrical installation, if appropriate.
- This appliance does not require a chimney, but **must be** installed against an outside wall.
- It is important that the flue terminal is regularly checked and kept clear at all times.
- If the terminal is accessible to people (i.e. less than 2m above a walkway, balcony etc.) the terminal guard must be fitted to prevent access to the flue outlet, which becomes hot when the fire is in use.
- All combustible material must be removed from behind the fire and fire trim.
- As the PARAGON FOCUS RS PLUS REMOTE is a room sealed appliance (i.e. air for the combustion process is taken from outside the room) no purpose built ventilation is required.
- The PARAGON FOCUS RS PLUS REMOTE is designed and tested to meet the requirements of the European Standard EN 613.

SECTION ONE Important Information Cont.

The PARAGON FOCUS RS REMOTE is battery operated; therefore no mains electrical supply is required. Power to the appliance is provided by 6 high power alkaline 1.5V batteries (AA size) (a spare set of 6 AA batteries is supplied with the appliance); these batteries can be changed to Nickel Metal Hydride rechargeable batteries providing they have a minimum capacity of 2200 mAh. A set of 6 high power alkaline 1.5V batteries (AA size) would give in the order of 200 -380 operations while 6 rechargeable batteries when fully charged would give approximately 200-300 operations. These figures are only given for guidance and may vary depending on how the appliance is used and the battery manufacturer and quality.

A special long life lithium battery is available as an optional extra and would be expected to give in excess of 12 months normal use (a minimum of 1000 operations), however it is not subject to the guarantee. For more information call the telephone number located on the back of this booklet.

Using the standby facility when the appliance is switched off for short periods can extend battery life. The standby facility switches off the mains gas supply to the appliance but the pilot remains alight.

An audible repeated bleep warning indicates that the appliance batteries need changing or charging (if rechargeable batteries have been used).

Important: Batteries should be changed or recharged as soon as possible as the appliance will not light if the battery power gets to low.

- Although the PARAGON FOCUS RS PLUS REMOTE is fitted with a glass front which acts as a dress guard it is strongly recommended that a fireguard should be used for the protection of children, the elderly or infirm. Fireguards should conform to B. S. 6539 (1984) (Fireguards for use with solid fuel appliance).
- The slot located at the top of the PARAGON FOCUS RS PLUS REMOTE are the hot air outlets and as such must not be obstructed in any way (particularly by clothes or other combustibles). In addition the base of the appliance should not be obstructed by such items as this may adversely affect the performance of the appliance.
- Care should be taken to prevent any damage being caused to surrounding soft furnishings or decoration. Many wall coverings may become discoloured if placed too close to the appliance, it is strongly recommended that any proposed wall covering intended for use immediately above the appliance should be tested in the hottest position (immediately above) first. Run the fire on high over a few days
- All combustible material must be removed from behind the fire and fire trim.
- The first time you light your new appliance a smell may occur due to its new condition. This is quite normal and will soon disappear after a few hours use at maximum setting (open a window until the smell disappears).
- The appliance **MUST NOT** be used if the glass panel is not correctly fitted or if this panel is cracked or broken.
- Any debris should be cleaned from the appliance. A vacuum cleaner can be used but only after all the loose coals have been removed.
- ***Prior to removing or cleaning the fuel bed components refer to the 'Health and Safety Notice' located on page 3 of this booklet.***
- The appliance should be serviced annually by a competent person i.e. a **GAS SAFE registered engineer** in accordance with these instructions.
- The glass or any part of the appliance **MUST NOT** be cleaned or wiped whilst the appliance is **HOT**, to do so could be dangerous and may damage the paintwork of the appliance.
- The cast fire front or Fascia casing **MUST BE** positioned in front of the fire whilst it is burning.
- A where a fire front (fret) is used with this appliance it must conform to the following:

SECTION ONE Important Information Cont.

- It must be made from non-combustible material.
- Its general construction should enable it to stand firmly across the full width of the burner.
- The design of the fire front (fret) must have a removable ashtray cover (lower section).
- The ash tray cover must have cut outs and or holes which provide ventilation to the underside of the burner.
- The effective area of ventilation through the ash tray cover must be greater than 1365mm^2 (2.12 sq. ins.)

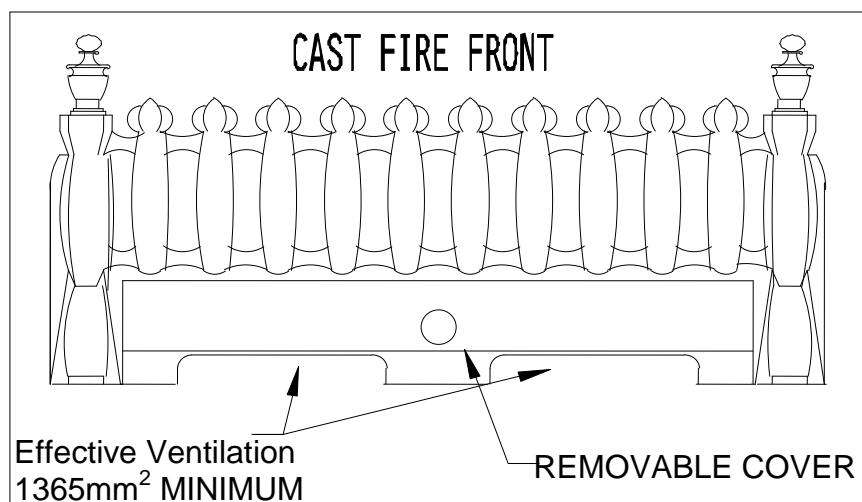

SECTION TWO Introduction

- The PARAGON FOCUS RS PLUS REMOTE is an inset room sealed live fuel-effect gas appliance designed for use in locations that do not have a conventional chimney. The appliance must be installed against an outside wall because the air to support combustion is taken from the outside and the products of combustion are expelled to the outside.
- The appliance incorporates a safety device in the form of a FLAME SUPERVISION DEVICE, which constantly monitors the flame and will cause the gas to be switched off if the flames are extinguished for any reason. **THIS DEVICE MUST NOT BE OVERRIDDEN.** If this situation occurs on a regular basis have the appliance checked by a qualified engineer. The problem may be due to a blocked or restricted flue.
- Before removing the fret, trim, glass or fuel bed for cleaning the fire should be turned off, and left to cool down.
- **NOTE:** In use some discoloration of the components will take place in the combustion box, this is normal, but can be kept to a minimum if the coals are placed correctly (i.e. after cleaning). See Section 4.
- As with all heating appliances certain areas (Working Surfaces) become very hot when the appliance is in use. Only the ashpan knob and the gas control knob should be touched when the fire is being used.

PARAGON FOCUS RS PLUS REMOTE Users Instructions

SECTION THREE Operating the Appliance





Do not use this appliance without the glass panel fitted, or if this panel is cracked or broken.

WARNING: If the burner or pilot is extinguished for any reason, do not attempt to re-light the pilot for at least three minutes.

LIGHTING THE FIRE

Before attempting to operate the appliance check that nothing has been placed in front of the appliance that may interfere with the remote sensor operation.

To light the appliance using the remote hand set:

- Point the remote control hand set in the direction of the appliance and simultaneously press the buttons marked '●' and 'standby'. Continue to hold in these two buttons until a 'bleep' is heard (approximately 2-3 sec.) and then release these buttons. The appliance will automatically go through the ignition sequence and the pilot should ignite. Once the pilot is alight the appliance will automatically go to the high setting (approximately 20-25sec). If the ignitor stops sparking and the pilot fails to light, repeat this procedure.
- If the ignitor stops sparking and the pilot fails to light press the ● button before repeating this procedure.
- The appliance can be adjusted up or down by pressing the appropriate button  (low setting) or  (high setting). These buttons have a dual function. If they are pressed until a 'bleep' is heard and then released immediately the appliance will automatically go to the maximum  or minimum settings . On the other hand if the button is not released, gradual adjustment is made until the button is released or until the maximum or minimum setting is reached.
- To switch off the appliance press the ● button or if the appliance is to be switch off for a short period it is recommended that the 'standby' button be used. This switches the main burner off but leaves the pilot on and will extend battery life.
- The appliance can be switch off with out using the hand set by removing the appliance batteries located behind the ash pan cover. When the batteries are removed there will be a delay (up 3minutes) after which double bleeps may be heard and shortly after the appliance will extinguish. Ensure that the battery is reconnect once the fire as been extinguished. The appliance cannot be operated without the use of the handset.

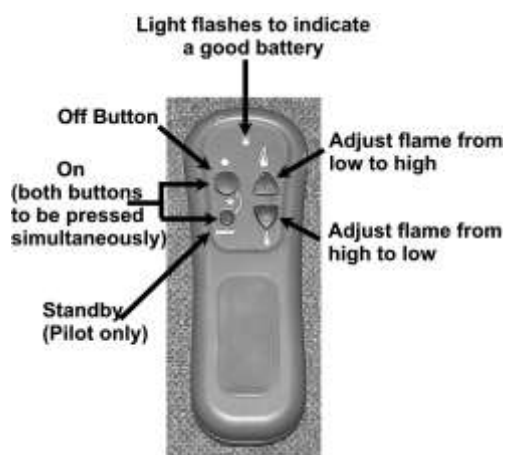

NOTE: If the fire is extinguished for any reason wait 3 minutes before relighting.

Low Battery Indication (Hand Set)

If while pressing any of the buttons on the remote hand set the low battery indicator lamp either stops flashing or appreciably slows then the battery should be changed.

To Replace Battery In Hand Set (9v Size Mn1604 Or 6f22)

Remove the cover from the rear of the handset and fit replacement battery. Take care not to stain the battery connections.

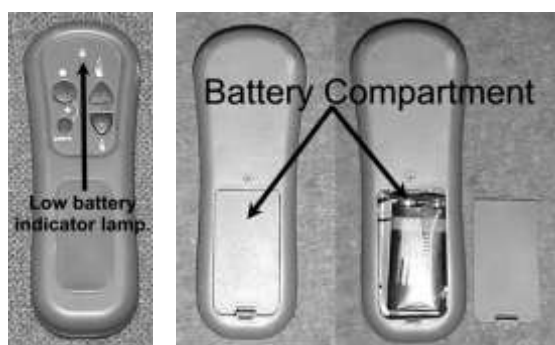

PARAGON FOCUS RS PLUS REMOTE Users Instructions

SECTION THREE Operating the Appliance Continued

Low Battery Indication (Appliance)

If you hear a repeated 'bleep' sound come from the appliance this indicates the appliance battery pack is low and should be changed as soon as possible. The appliance will continue to work normally for a short period but if the warning is ignored you may experience difficulty lighting the appliance or the appliance may automatically switch off for no apparent reason.

NOTE: The appliance cannot be used when the battery is completely flat.

To replace appliance batteries (6 high power alkaline AA 1.5v)

(Rechargeable batteries can be used providing they are a nickel metal hydride type 1.5V AA with a minimum capacity of 2200mAh).

(A long life lithium battery is available as an optional extra call the number shown on the last page of these instructions for further information).

- Lift off fret and ash pan or fascia.
- The battery power pack or holder is located at the left hand side of the burner; carefully slide the battery holder forward and replace the six high power alkaline AA batteries as a complete set or recharge as appropriate. **WARNING, batteries will overheat if fitted incorrectly, when fitting the batteries ensure that they are fitted as per the marking on the rear of the holder (i.e. minus of battery against spring).** If rechargeable batteries are used they MUST be a Nickel Metal Hydride type with a minimum capacity of 2200mAh.

- If the appliance is fitted with the special lithium battery (optional) disconnect the wires at the battery connector and replace ensuring the connection is made correctly.

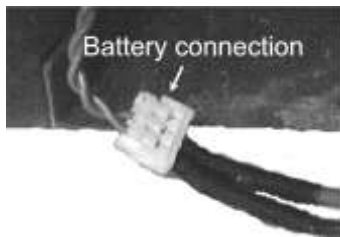

BATTERY CONNECTION

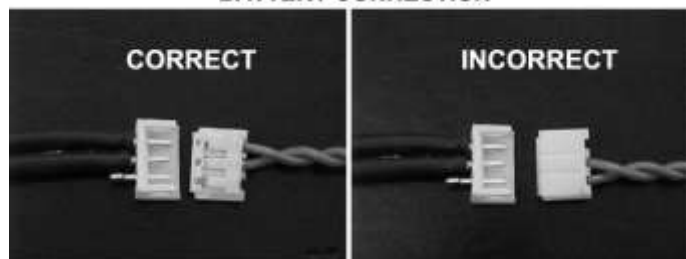

- Important:** Ensure that the battery pack is placed on the base of the appliance to the left hand side of the burner. Refit fret and ash pan cover or fascia.
- Once the new batteries are loaded the fire will continue to bleep until re-set. This can be done by pressing the "off" button on the handset followed by the normal ignition sequence as above. If the fire continues to bleep this may indicate a loose connection or badly loaded batteries.

SECTION FOUR Cleaning & Fuel Bed Laying

Warning: -Before you clean any part of the appliance ensure that the appliance is switched off and cool.

CLEANING: DECORATIVE TRIM

- The Decorative finish of the trim is coated with a high temperature lacquer, it should be wiped with a soft, clean, dry, cloth only.
- The trim should be removed for cleaning. The fret should be removed before removing the trim, which is held in place by four magnets.

CLEANING: BLACK PAINTED SURFACES

- These surfaces should be dusted regularly and any marks removed with a soft cloth.
- Abrasive or chemical cleaner should never be used.

CLEANING: GLASS PANEL

From time to time it may be necessary to clean the glass panel.

We recommend you use a Ceramic Hob Cleaner (brands such as **HOB BRITE** and **VITRO CLEAN** have been found to be acceptable) these are available from most leading Supermarkets.

Remove the glass panel as follows:

- Remove ash pan cover and fret.
- Remove decorative trim (held in place with four magnets).
- Remove the 2 nuts that hold the fret cover on, and remove fret cover.
- Slacken but **do not remove** the 4 nuts securing the glass frame.
- Remove the 2 nuts located on the bottom of the glass frame. **Note:** when it is replaced ensure the glass is central and that all the four studs pass through the slots in the glass frame.
- While supporting the glass panel, remove the 2 nuts securing the sides of the glass frame, remove the glass frame and slide it out gently.
- Lay the glass panel down on a flat working surface on top of an old opened newspaper with the side to be cleaned uppermost **take care not to erase the dot printing in the cleaning process.**

Follow the Instructions on the Hob Cleaner Bottle.

On stubborn stains (where the appliance has been used for a long period without glass panel being cleaned), use a new **Brillo Pad** well wetted with the Hob cleaner applied directly to it.

Ensure all the residues of the cleaner are removed with a damp cloth and the glass panel is completely dry before fitting to the appliance.

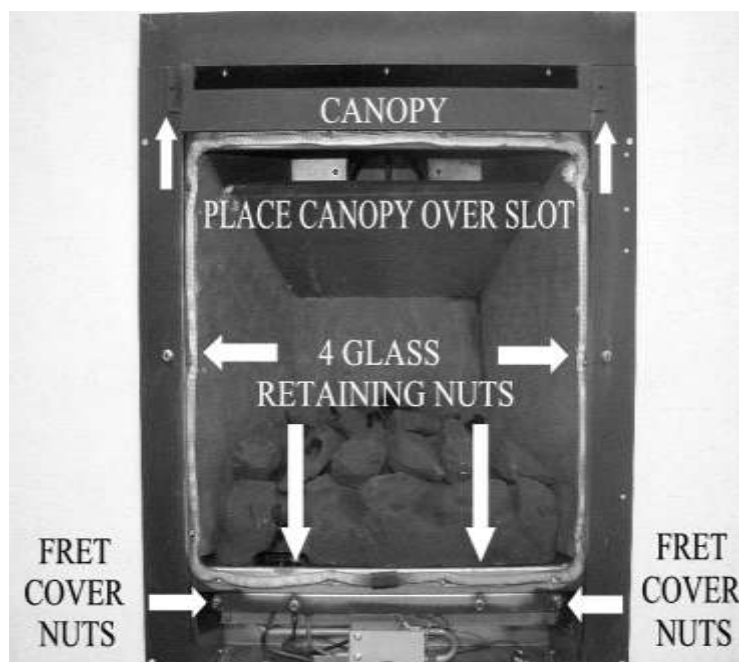

SECTION FOUR Cleaning & Fuel Bed Laying Continued

Note: - If the fuel bed has not been placed correctly, causing the gas flame to contact the glass this may result in glass staining that cannot be removed by cleaning.

Re-assemble in reverse order ensuring the seal is compressed evenly at the top and bottom

Re-fit the top outlet grill before re-fitting the trim and fret and before re-lighting.

CLEANING AND REPLACING Fuel Bed Parts

Important: - Refer to the 'Health & Safety Notice located on page 3 of this booklet before cleaning or replacing any refractory material.

Use only the Fuel Bed part provided NO OTHER FUEL BED PARTS SHOULD BE ADDED to the appliance

If any Fuel Bed Parts are broken then they must be replaced before the appliance is used.

**Note:- There are two possible fuel bed arrangements
COAL or PEBBLE**

Please check the label on the appliance carton to ensure you have the correct fuel bed

The fuel bed parts are delicate and should be handled with great care.

The loose part should be removed for cleaning. They can be brushed very gently with a soft brush to remove dust or any deposits.

A vacuum cleaner may only be used after all the loose coals have been removed.

NOTE: During operation some sooting will be evident on the fuel bed whether running on the high or low setting. This may be reduced by running on the opposite setting for 15 minutes prior to switching the fire off i.e. If fire is running on high then turn to low for 15 minutes before turning off. This will not eliminate all soot but helps keep it to a minimum.

SECTION FOUR Cleaning & Fuel Bed Laying Continued

COAL BED LAYOUT

- The Coal set as shown consists of:
 - Rear Matrix
 - Front Matrix
 - 10 x Individual Coals
- The Front Matrix is located as shown in front of the burner

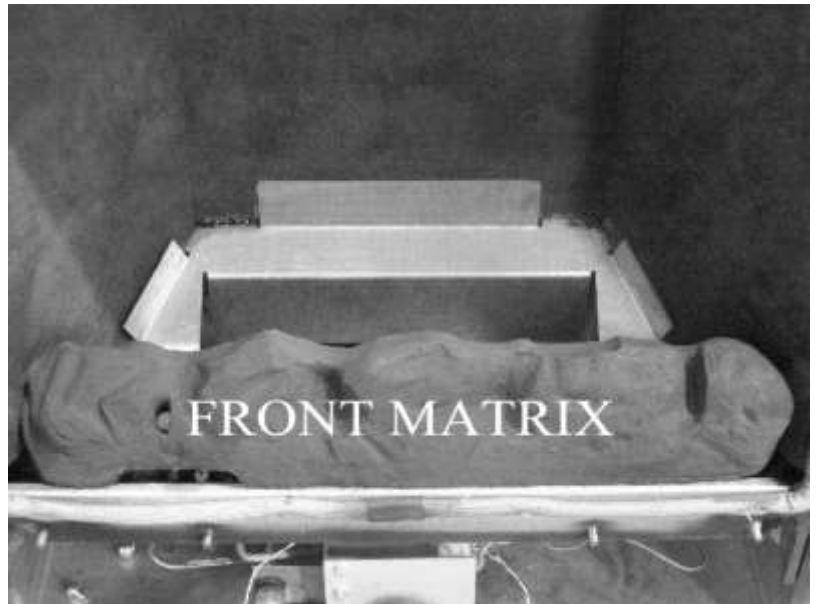

- The Rear Matrix is located so that it fits behind the burner (ensure it is not placed over the burner)

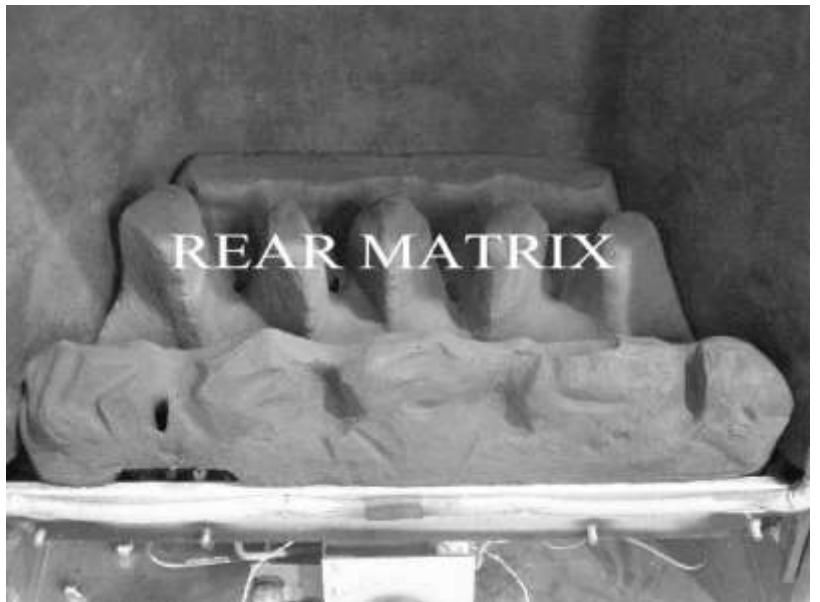

SECTION FOUR Cleaning & Fuel Bed Laying Continued

- Insert back row of 4 coals as shown.

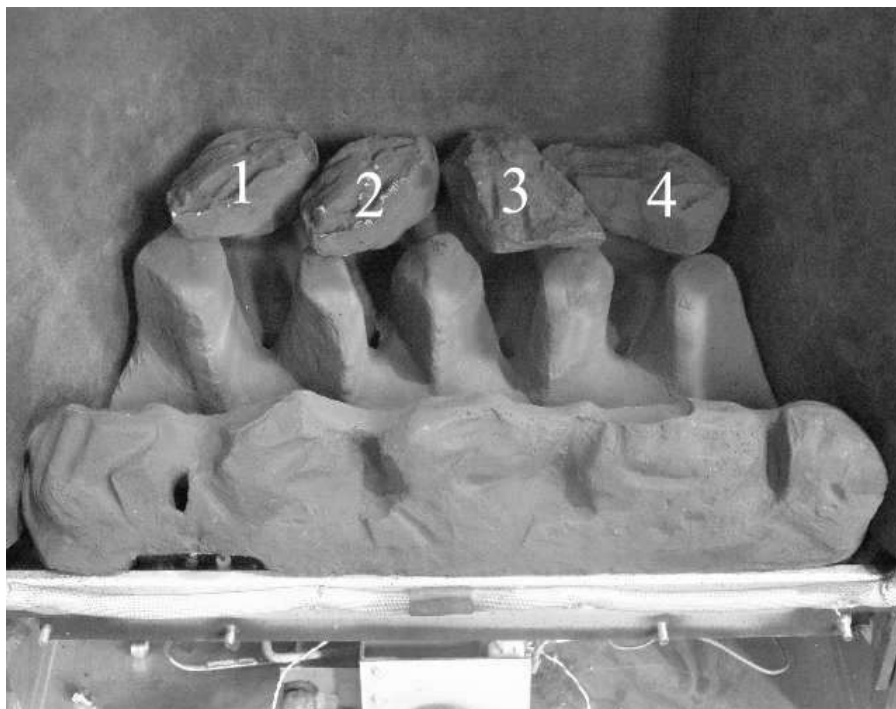

- Complete front row of 6 coals as shown.



- That completes the coal bed assembly
- Go to section eleven to complete the appliance assembly
- Ensure the glass panel and other associated parts are fitted before lighting the appliance

SECTION FOUR Cleaning & Fuel Bed Laying Continued

The Pebble set as shown consists of:

Front Matrix
Rear Matrix
3 x "A" Pebbles
6 x "B" Pebbles

- The Front Matrix is located as shown in front of the burner

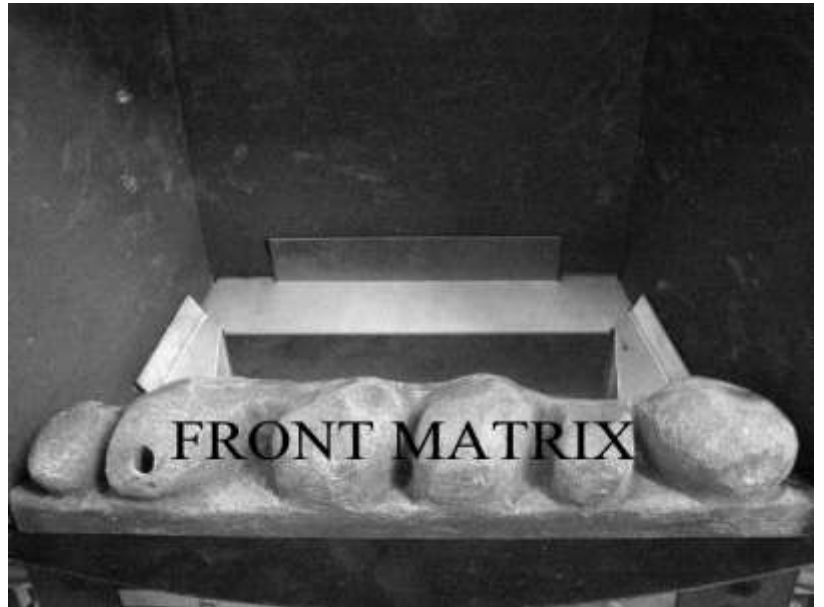

- The Rear Matrix is located so that it fits behind the burner (ensure it is not placed over the burner)



- Position the front row of "A" & "B" shape pebbles as shown.



PARAGON FOCUS RS PLUS REMOTE User Instructions

SECTION FOUR Cleaning & Fuel Bed Laying Continued

- Finally position the remaining 4 "B" shape pebbles as shown.
- That completes the pebbles bed assembly
- Go to section eleven to complete the appliance assembly
- Ensure the glass panel and other associated parts are fitted before lighting the appliance



SECTION FIVE Replacement Parts

The only user removable parts are: -

- Cast fret
- Top Outlet Grill
- Glass panel frame and fret apron
- Decorative Trim
- Refractory fuel bed components

PARAGON FOCUS RS PLUS REMOTE Installation Instructions

SECTION SIX Appliance Data

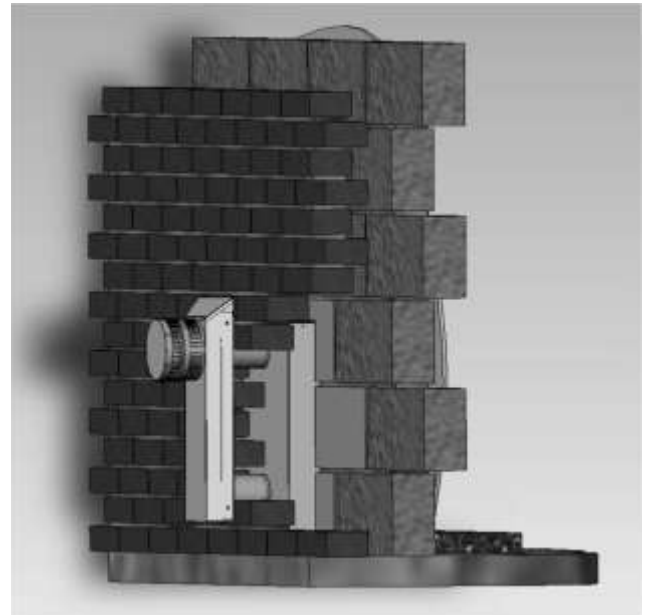
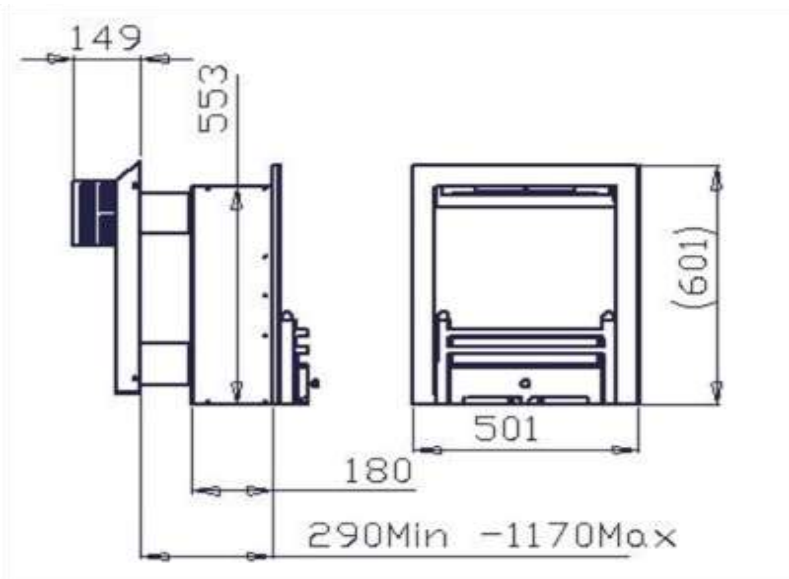

Wall Cut-out dimensions:.....	Height	553mm
	Width	405mm
Overall dimensions:.....	Height	601mm
	Width	501mm
Forward Projection:.....	90mm, (From fireplace opening Including typical fret.)	
Weight:.....	38.5kg (Boxed excluding fret)	
	37kg (Unboxed excluding fret)	
Flue Length and duct length:.....	100mm (minimum) to 1 metre (maximum)	
	Standard length supplied with fire-535mm (267mm after cutting). Additional 535mm & 1m tubes supplied as optional extras. (No bends should be fitted in the flue pipe)	
Injector Tips x 2.....	1x 360 tip (5.4kw)fitted & 1x 220 tip (3.8kw)supplied	
Pressure Test Point Location:.....	Gas inlet elbow	
Gas Connection:.....	8.0mm O/D, tube.	
Data Badge Location:.....	On the base of the appliance behind the fret	

MODEL	N G(G20) Version 5.4 inj	N G (G20) Version 3.8 inj
Category of appliance	C _{II}	C _{II}
NO _x Class	3	3
Efficiency Class	1	1
Gas Category	I _{2H}	I _{2H}
Gas Type	G20 Natural Gas	G20 Natural Gas
Gas Pressure +/- 1.0mbar	20 mbar	20 mbar
Gas Input (Max)	5.4 kW Gross	3.8 kW Gross
(Min)	2.4 kW Gross	2.4kW Gross
Injectors size	360	220

NOTE: The efficiency of this appliance has been measured as specified in BS EN613-2001 and the result is 79.14.% for 5.4kw & 75.68.% for 3.8kw natural gas The gross calorific value of the fuel has been used for this efficiency calculation. GasTec have certified the test data from which it has been calculated. The efficiency value may be used in the UK Government's Standard Assessment Procedure (SAP) for energy rating of dwellings.

SECTION SEVEN Regulations and Warnings

- This appliance must only be installed in Great Britain or Ireland.
- The appliance is available in natural gas only.
- Confirm that the appliance is suitable prior to installation (*g20 for natural gas*) (refer to data badge on base of appliance). *Note: the appliance should only be used on the appropriate gas specified. It is not suitable for conversion from one gas to the other.*
- This appliance must be installed on a suitable outside wall.
- No special ventilation bricks or vents are required into the room containing the appliance.
- **In GB (Great Britain)**

It is the law that all gas appliances must be installed by a competent person; i.e. a GAS SAFE registered installer, in accordance with the current Gas Safety (Installation and Use) Regulations (as amended), all relevant parts of the local and national building regulations and all relevant recommendations of the current British Standards. Failure to do so could lead to prosecution.

The following are the relevant codes of practice and British Standards: -

B.S. 5871 PART 2

B.S. 5440 PART 1

B.S. 6891

B.S. 1945

Note:- This appliance must be installed to current versions of the above standards and include any relevant amendments.

The Building Regulations issued by The Department of the Environment.

The Building Standards (Scotland) (Consolidated) Regulations issued by The Scottish Development Office.

- **In IE, (Ireland)**

The appliance must be installed by a competent person and installed in accordance with the current edition of I.S.813 Domestic Gas Installation, the current building regulations, and the current ETCI rules for electrical installation, if appropriate.

WARNINGS

- As this appliance has components, which get very hot as with all such fires, it is recommended that a fireguard should be used for the protection of children, the elderly, or the infirm. Fireguards should conform to B.S.6539 (1984) (Fireguards for use with solid fuel appliances).
- During initial use, an odour may be evident. This will soon disappear if the fire is run on its maximum setting for a few hours.
- Care must be taken to prevent any damage being caused to surrounding soft furnishing or decoration, e.g. wall coverings may become discoloured if placed too close to the appliance.

SECTION EIGHT Siting the Appliance

(When installing in a timber framed dwelling reference must be made to the specific installation requirements stated in **Section 10 Installing the Appliance in Timber Framed Dwelling**).

THERE ARE TWO TYPES OF INSTALLATION (into conventional masonry walls): -

- The appliance body can be recessed back into the brickwork cavity so that the appliance is flush fitting with the wall or fireplace back panel, see Installation Instructions,

OR

- With a dummy chimneybreast constructed forward into the room to take up the 180mm depth of the firebox. This depth can be reduced if a deep rebated surround is also used the rebate depth can be deducted from the dummy breast depth

Any surround used must meet the specification stated later in this section. Prior to installing the appliance all combustible materials must be removed from the rear faces as described in Section 10.

GENERAL REQUIREMENTS

- The flue and air duct length must be between 100mm to 1metre. The fire is supplied with a standard pipe length of 535mm (to be cut in half to make a flue and air duct length of 267mm) The flue and air duct must not accommodate any bends. Other lengths of flue and air duct are available
- The flue outlet must terminate on a suitable outside wall.
- The minimum flue terminal clearances, which must be maintained, are as shown below.

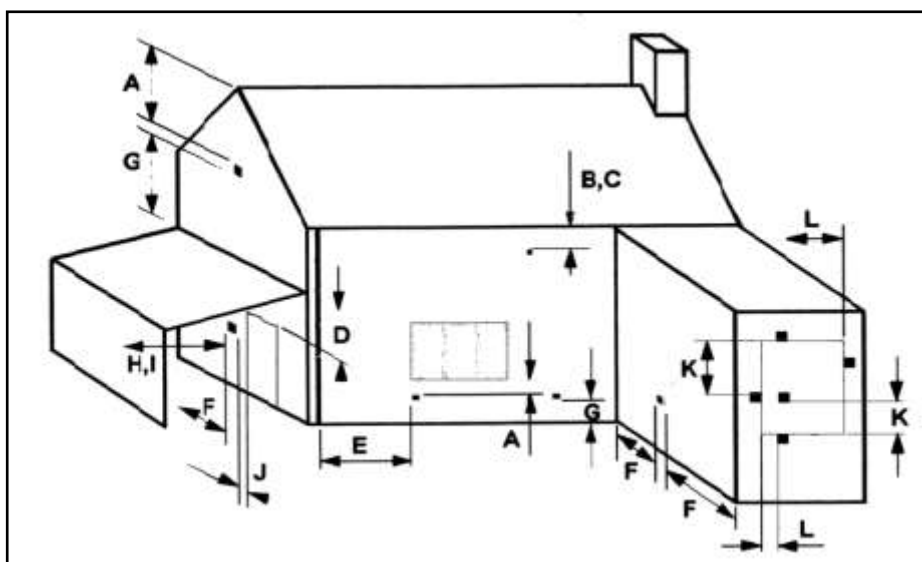

A	Directly below an openable window or other opening. E.g. air brick.....	300mm
B	Below gutters, soil pipes or drain pipes.....	300mm
C	Below eaves.....	300mm
D	Below balconies or car port roofs.....	600mm
E	From vertical drain pipes and soil pipes.....	75mm
F	From internal and external corners.....	300mm
G	Above ground, roof or balcony level.....	370mm
H	From a surface facing the terminal.....	600mm
I	From a terminal facing the terminal.....	1200mm
J	From an opening in a car port into a dwelling e.g. door, window, etc.....	1200mm
K	Vertically from a terminal on the same wall.....	1500mm
L	Horizontally from a terminal on the same wall.....	300mm

Note: These dimensions are taken from the centre of the circular flue outlet.

SECTION EIGHT Siting the Appliance Continued

To minimise the risk of cracking due to heat expansion the use of a 3 – piece back panel is recommended

- The back panel of the surround must have a cut-out within the maximum and minimum dimensions as shown.
- Ensure that gas supply is suitably sited.
- A non-combustible hearth must be provided beneath the appliance if the appliance is fitted at low level (less than 150mm from floor). The hearth must have a minimum thickness of 12mm and the perimeter 50mm above floor level. The hearth must extend the full width of the appliance and must project forward a minimum of 100mm in front of the appliance.

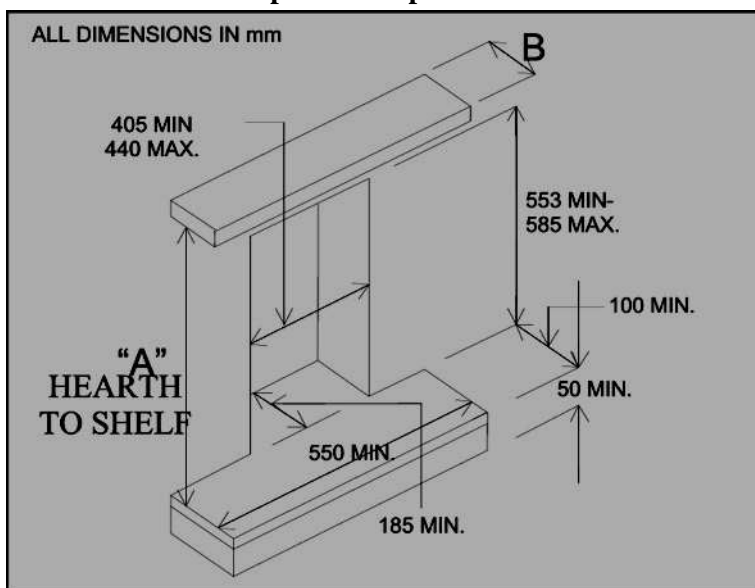

- Alternatively the appliance may be fitted without a hearth (Hole in the Wall type installations), 50mm min. from the floor to the base of appliance
- The minimum clearance from the hearth (base of appliance) to the underside of a combustible shelf should be determined using the shelf chart.
- Minimum width between vertical sides of combustible surround should not be less than 800 mm provided fire is central to the surround and sides do not project more than 150 mm. When vertical side forward projection is increased by 12.5 mm add 50 mm to inside width of surround.
- Check with the supplier or manufacturer that the surround meets 150°C minimum rating (attention should especially be given to man made materials such as resin).
- When installing in a timber framed dwelling reference must be made to the specific installation requirements stated in **Section 10 Installing The Appliance In Timber Framed Dwelling.**

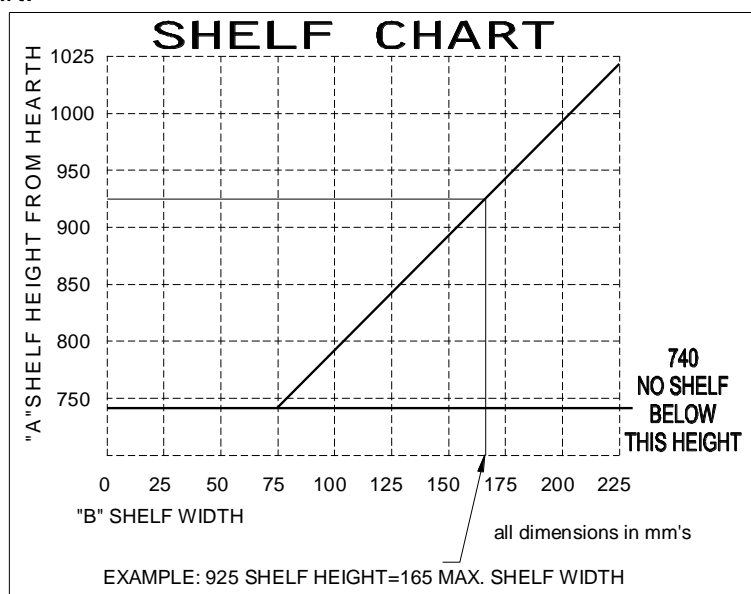

SECTION NINE Preparing the Appliance for Installation

- Carefully unpack the appliance from the carton and check the contents.
- Lift off the decorative trim, which is held by four magnets and put to one side.
- Lift away the fascia grill unit, which hooks over the lip of the combustion chamber.
- Lay the appliance on its back ensuring suitable protection is provided for the carpet / floor.
- Remove the two cross head nuts securing the fret apron and remove the apron
- Remove the 2 nuts located on the bottom of the glass frame. **Note:** when it is replaced ensure the glass is central and that all the four studs pass through the slots in the glass frame.
- Remove the 2 nuts securing the sides of the glass frame, remove the glass frame and slide it out gently.
- Remove the refractory components from the inside of the appliance.
- The appliance is now ready for installation.

SECTION TEN To Install the Appliance

INSTALLING THE APPLIANCE INTO CAVITY WALL (When installing in a timber framed dwelling reference must be made to the specific installation requirements stated later in this **Section 'Installing The Appliance In Timber Framed Dwelling'**).

- Ensure it is a suitable outside wall constructed of non-combustible materials and that the flue position meets the requirements previously described in **Section 8**.
- Mark a horizontal line on the wall at the intended hearth surface or appliance base height (50mm min for Hole in Wall installation (the skirting board must be cut away from behind the fire)).
- Mark a vertical line on the wall at the intended centre of the appliance up from the horizontal line for a height of 555mm.
- Mark two more vertical lines 202mm either side of the centre line for a height of 555mm.
- Mark a horizontal line at a height of 555mm above the hearth line, joining the two outside lines together.
- Mark the position for a lintel above the top horizontal line.
- Mark three short horizontal lines so they cross the centre line, one at 105mm one at 332mm and one at 480mm above hearth level line. These are the centre points for the air duct, flue holes and wire fixing kit.
- Using a long masonry drill, make three pilot holes completely through the wall, ensure the holes are drilled accurately at the centres and square to the wall both horizontally and vertically at the cross points previously marked.
- Cut out the brickwork of the inner skin of the cavity wall for the lintel, and position and fix the lintel with mortar.
- Cut out the brickwork under the lintel, between the two outside vertical lines into the cavity. Ensure the cut-out width is square, try the appliance into the opening.
- Using 125mm (5") core drill, cut two holes following the pilot holes, drill from the outside through to the cavity.
- Remove any cavity insulation from the cut-out opening and for a further 100mm into the cavity gap each side and above.
- Pack "Rockwool" around the sides and top of the opening into the cavity for a depth of 100mm.
- Lay the hearth if required so that it is positioned correctly to the horizontal line.
- Position and fix the back panel and surround if required.
- Offer the appliance into the opening and mark through the gas pipe entry hole (see connecting the gas supply later in this manual).
- Pass a tape measure through the core-drilled holes and record the distance from the back of the spigots to the surface of the outside wall.

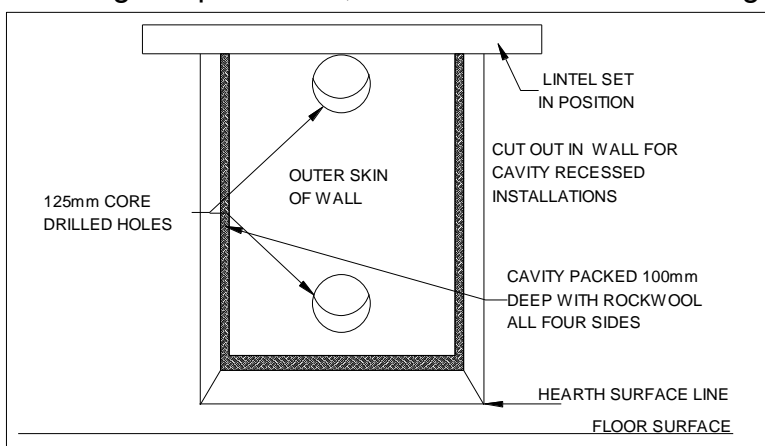
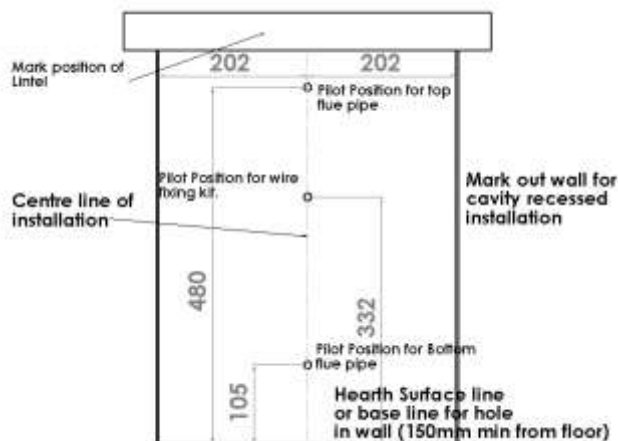

SECTION TEN To Install the Appliance Continued

- Increase both the recorded distances by 15mm each, and cut two lengths from the 100mm diameter pipe.
- Remove the appliance from the opening, and position the gas supply (see connecting the gas supply later in this manual), taking account of the relative gas regulations appertaining to a gas pipe in a cavity. Note the gas feed must be fitted with an isolation valve.
- Position and seal the pipes to their respective spigots on the rear of the appliance (use flue seal or fire cement to ensure airtight seal, it must not obstruct the flue).
- Peel the backing off the length of foam seal and affix to the rear outer edge of the appliance flange.
- Push the appliance back into the opening and fill any space behind the appliance with “Rockwool”.
- Complete the gas connection (see connecting the gas supply later in this manual).
- Drill the four fixing holes through the hole in the flange of the appliance and fix back using plug and screws.

Using the optional wire fixing kit:

Follow all the above steps up to connecting the gas supply.

Undo the 2 central M6 screws from the bracket on rear of the firebox and slide the wire fixing clamp off.

Unravel the cable and push the nipple end onto the bracket. Replace the fixing clamp and screws and secure tightly. The cable is now attached to the firebox.

Push cable through the central pilot hole that has been drilled in the outside wall. Go outside and pull any excess cable through. Come back inside and push the firebox into the opening, ensuring the fire is level and the seal is evenly fitted to the back panel.

Go back outside and, again, pull any excess cable through the pilot hole. Slide the wall mounting plate over the cable using the centre hole. Align the cable fixing hole over the central pilot hole.

Mark the hole centres, drill, and fasten back to the external wall using screws and raw plugs (not provided).

Adjust nut and slide down the cable over the wall mounting plate into the central pilot hole.

Slide the provided clamp over the cable, pull any excess then tighten using the screw on the clamp.

Using a 10mm spanner adjust the locking nut until tight.

Go back inside to ensure the seal on the fire is tight against the back panel and fire.

Go back outside and wrap any excess cable around the ledge on the bracket and through the feed hole.

Important: Do not cut off excess cable.

Note: Please check the adjustment on the fixing is no more than 15mm as this may cause difficulty when fitting the outer terminal.

- Fit the outer wall terminal plate, with the “Rockwool” gasket sandwiched between it and the wall, with the double spigot at the top so that it seals to both the flue pipe and the air duct, (use flue seal or fire cement to ensure air tight seal).
- Drill through the four holes in the outer wall terminal plate and fix back to the wall using plugs and screws.
- Position the outer terminal cover and fix to wall terminal plate with the four screws provided.
- If the flue outlet is fitted below 2m from the floor or a balcony then the flue guard must be fitted.

SECTION TEN To Install the Appliance Continued

INSTALLING THE APPLIANCE INTO DEEP REBATED FIRE SURROUND OR DUMMY CHIMNEY BREST. Additional duct pipe/s will be required. (When installing in a timber framed dwelling reference must be made to the specific installation requirements stated later in this Section 'Installing The Appliance In Timber Framed Dwelling').

- Ensure it is a suitable outside wall constructed of non-combustible materials and that the flue position meets the requirements previously described.
- Mark a horizontal line on the wall at the intended hearth surface or appliance base height (150mm min. for Hole in Wall installation) the skirting board must be cut away from behind the fire.
- Mark a vertical line on the wall at the intended centre of the appliance up from the horizontal line for a height of 555mm.
- Mark two short horizontal lines so they cross the centre line, one at 105mm and the second at 480mm above hearth level line. These are the centre points for the air duct and flue holes.
- Using a long masonry drill, make two pilot holes completely through the wall, ensure the holes are drilled accurately at the centres and square to the wall both horizontally and vertically at the two cross points previously marked.
- Using 125mm (5") core drill, cut two holes following the pilot holes, drill from the outside of the dwelling through to the cavity, and from the inside through to the cavity
- Remove any combustible material that may be present if the rear of the appliance is contacting the wall i.e. ensure no battens etc., behind dry lining
- Lay the hearth or a non-combustible base (for Hole in Wall) so that it is positioned correctly to the horizontal line.
- Temporally position and fix the back panel and deep surround, or construct a dummy chimney breast as required, avoiding combustible materials coming in close proximity to the appliance or the flue, leaving access to pack around the appliance with "Rockwool".
- Offer the appliance into the opening and mark through the gas pipe entry hole (see connecting the gas supply later in this manual).
- Pass a tape measure through the core-drilled holes and record the distance from the back of the spigots to the surface of the outside wall.
- Increase both the recorded distances by 15mm each, and cut the lengths from the 100mm-diameter pipe - you will probably require an extra pipe.
- Remove the appliance from the opening, and position the gas supply (see connecting the gas supply later in this manual), taking account of the relative gas regulations appertaining to a gas pipe in a cavity.
- Permanently fix the deep rebated surround in position, and pack the void behind the fascia panel of the deep rebated surround with "Rockwool". Pack 150mm thickness of "Rockwool" over the

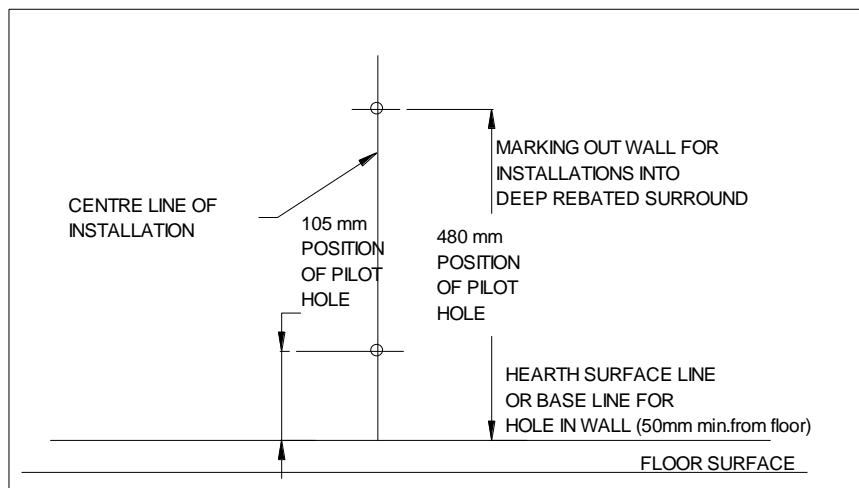

SECTION TEN To Install the Appliance Continued

- appliance top and side if it is fitted into a dummy chimneybreast, and fill any space between the appliance and the outside wall.
- Position and seal the pipes to their respective spigots on the rear of the appliance (use flue seal or fire cement to ensure airtight seal, it must not obstruct the flue).
- Peel the backing off the length of foam seal and affix to the rear outer edge of the appliance flange.
- Push the appliance back into the opening and fill any space behind the appliance with “Rockwool”.
- Complete the gas connection (see connecting the gas supply later in this manual).
- Drill the four fixing holes through the hole in the flange of the appliance and fix back using plus and screws.
- Fit the outer wall terminal plate, with the “Rockwool” gasket sandwiched between it and the wall, with the double spigot at the top so that it seals to both the flue pipe and the air duct, (use flue seal or fire cement to ensure airtight seal, it must not obstruct the flue).
- Drill through the four holes in the outer wall terminal plate and fix back to the wall using plugs and screws.
- Position the outer terminal cover and fix to wall terminal plate with the four screws provided.
- If the flue outlet is fitted below 2m from the floor or a balcony then the flue guard must be fitted.

SECTION TEN To Install the Appliance Continued

TIMBER FRAMED DWELLING

This method allows for installation in timber frame buildings. Where removal of any part of the inner timber leaf of the wall is involved the structural integrity of the wall must be maintained and the advice of your local Building Control Department should be sought. If the property is under N.H.B.C. cover, it is advised that their advice should also be sought. Reference should be made to the British Gas Publication DM2 "Guide For Gas Installations In Timber Frame Housing" or GAS SAFE "Gas installations in Timber Frame Buildings" ISBN1-902632-30-3

Special attention must be paid to the location of the studwork frames of the inner leaf and the appliance positioned accordingly. Electrical cables and pipework that run within the inner timber leaf must also be located and taken into account when positioning the appliance.

The following methods of installation may be adapted for use in timber frame buildings providing extra care is taken to protect combustible materials from contact with hot surfaces.

Method 1 (For installation into a extended fire surround or false chimney breast)

- An insulation material (20mm "Superlux" or equivalent) must protect all combustible surfaces (including plasterboard) situated within the opening. A minimum clearance of 50mm must be allowed between the appliance case (rear, top and sides) and the material used to line the opening. The base of the opening must be non-combustible.
- Wrap the appliance body (top, rear and sides) and both flue tubes with "Rockwool" (50mm minimum thickness).
- Where the duct pipes pass through the inner timber leaf concentric holes 200mm diameter should be cut around each duct pipe, allowing a minimum 50mm air gap all round each duct pipe. A non-combustible sleeve 200mm diameter must be fitted to these clearance holes.
- To ensure that any condensation formed on the duct pipes does not drip on to the inner wall a length of galvanised wire must wrapped around each flue pipe and secured in position by twisting the ends together. Ensure that the twisted ends are located at the bottom of the pipes and the wire is centrally located within the cavity.
- The vapour barrier on the back of the inner timber leaf should be carefully cut and fixed to prevent ingress of damp into the plasterboard layer.

Method 2 (For installation into the inner timber leaf of the wall)

- Find a suitable position between the wall panel frames and carefully open up a hole (minimum dimension 505mm wide x 605mm x 230mm depth) this will ensure 50mm minimum clearance around the appliance body Note: the 230mm could be reduced to 200mm if no combustible material is left between the back of the fire box and the outer skin on brickwork. Careful attention must be made to securing the damp proof membrane back into position. (Note: To achieve the minimum depth requirement it may be necessary to deepen the cavity by building up the wall surface with an appropriate none combustible material.)
- Line the exposed cavity (top, rear and sides) with an insulation material (20mm "Superlux" or equivalent) to form a boxed chamber. The base of the opening must be non-combustible.
- Wrap the appliance body (top, rear and sides) and both flue tubes with "Rockwool" (50mm minimum thickness).
- Where the duct pipes pass through the inner timber leaf, concentric holes 200mm diameter should be cut around each flue pipe, allowing a minimum 50mm air gap all round each flue pipe. A non-combustible sleeve 200mm diameter must be fitted to these clearance holes.
- To ensure that any condensation formed on the duct pipes does not drip on to the inner wall a length of galvanised wire must wrapped around each flue pipe and secured in position by twisting the ends together. Ensure that the twisted ends are located at the bottom of the pipes and the wire is centrally located within the cavity.

SECTION TEN To Install the Appliance Continued

TIMBER FRAMED DWELLING CONTINUED

- The vapour barrier on the back of the inner timber leaf should be carefully cut and fixed to prevent ingress of damp into the plasterboard layer.

NOTE: Neither the appliance nor the “Rockwool” insulating pad may overhang the cavity space. Routing of the gas supply must be carried out inline with the recommendations specified in the British Gas Publication DM2 ‘Guide for gas installation in Timber Frame Housing.

CONNECTING THE GAS SUPPLY

TURN OFF ANY GAS APPLIANCES THAT ARE FED BY THE METER AND ISOLATE THE GAS SUPPLY BY TURNING OFF AT THE METER.

- Connections may be made from the front of the appliance from either the left or the right in 8mm-dia. pipe or a concealed connection from the rear of the appliance a hole with a grommet is provided at the rear.
- An isolating cock is fitted in the supply feed to the fire to facilitate servicing. It may be rotated for right gas connection.
- When a concealed gas fitting from the rear is required it is necessary to route the pipe to the left side of the unit, taking into account the requirements of BS 6891 1988 dealing with enclosed pipes.
- When installing the firebox into a cavity wall, any part of the installation pipe work installed in the void open to the cavity wall must be enclosed in a gas tight sleeve. It must be sealed at the point at which the sleeved installation pipe enters the fire (The Gas Safety (Installation and Use) Regulations Certificate of exemption number 1 of 1996). Where the pipe enters the fire the outer sleeve must be sealed to the grommet and the pipe must be sealed to its outer sleeve using suitable mastic.

CHECKING GAS SOUNDNESS

- Complete gas connection to the fire and check for gas soundness in accordance with current codes of practice.

INJECTOR REMOVAL

This appliance is fitted with the high input injector with the option of fitting the supplied reduced input injector. To change the injector firstly remove the burner bar. Remove the two screws at either side of the burner and lift out from the right hand side first.

The injector nipple can be changed with a spanner, change the injector ‘TIP’ only.

Refit the other Injector and retighten with a spanner. **NOTE: The other Injector needs to be left with the appliance or the customer.**

Refit the burner bar by sliding the left hand side first, make sure not to damage the injector tip when replacing burner bar.

Retighten the two screws and ensure the burner bar is central and flat to the burner carrier.

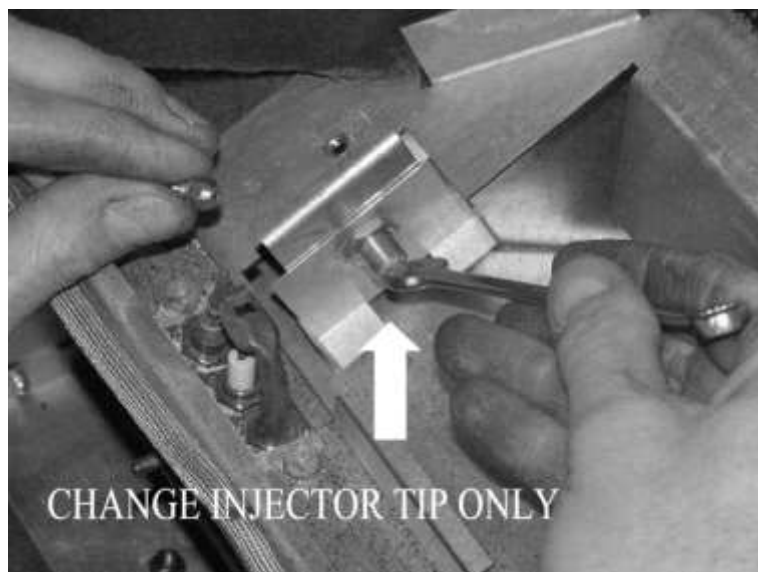

PARAGON FOCUS RS PLUS REMOTE Installation Instructions

SECTION ELEVEN Assemble the Appliance

- Position the refractory fuel bed components as described in section four of this manual, it is important that the fuel bed is positioned exactly as described to ensure the correct operation of the appliance. Badly positioned fuel bed components may result in the gas flame being driven forward onto the glass and permanently marking it.
- Special attention should be paid to the routing of the remote eye lead to ensure it does not touch the underside of the burner.
- Slide the top of the Glass Frame under the Glass Frame Bracket on the fire and centralize the slots over the Four fixing studs, making sure the seal inside the glass.
- Ensure it is positioned centrally with the printed surface to the inside and the open slots at the lower edge.
- Start the nuts on these four studs.
- Tighten the Four nuts up evenly ensuring that the glass compresses the seal on all four sides.
- Position the fret apron and secure with two cross head nuts
- Position the grill fascia so that it hooks centrally over the top flange of the combustion box and the front edge of the glass frame.
- Position four magnets in two up each side of the appliance flange, and offer the decorative trim up squarely and centrally.

SECTION TWELVE Check Operation of Fire

CHECK BURNER PRESSURE AND GENERAL OPERATION

- Remove the screw from the pressure test point on the burner inlet elbow and fit a pressure test gauge.
- Purge the air from the appliance by operating the appliance (see Section 3). The appliance will spark for approximately 20 seconds at which point if no ignition is detected the appliance will go to lock out and you must repeat the ignition procedure.
- Check that the electrode is sparking at the gap between the thermocouple tip and the electrode and that the pilot ignition is established. After approximately 20 seconds the main burner will light on the high setting.
- Check that the inlet pressure 20mbar +/- 1 mbar for natural gas.
- Refit pressure test point screw and check for leaks.
- Position a suitable fire fret up to the appliance conforming to the requirements referred to in section one of this manual.

SECTION THIRTEEN Instruct and Advise the Customer

- Demonstrate the lighting and extinguishing procedure to the consumer/user and the removal and refitting of the decorative trim for cleaning.
- Explain that for the first few hours of the fire operating there will be an initial odour. This is due to the curing of the paint, the appliance should be operated on its high setting, and it is recommended that a window is left open until that odour has completely disappeared.
- Instruct on the glass removal and refitting.
- Instruct on the fuel bed cleaning and advise that a vacuum cleaner can be used but only after all the loose fuel bed shapes have been removed. **Refer to 'Health & Safety Notice (See Section One) at the front of this booklet before proceeding.**
- Advise that the appliance should be serviced annually by a competent person i.e. a **Gas Safe registered engineer** in accordance with these instructions.
- Although the appliance is fitted with a glass front which acts as a dress guard it is strongly recommended that a fireguard should be used for the protection of children, the elderly or infirm. Fireguards should conform to B. S. 6539 (1984) (Fireguards for use with solid fuel appliance).
- **Hand these instructions to the user.**

SECTION FOURTEEN Maintenance Instructions

General

- Servicing should be carried out annually by a competent person such as a Gas Safe-registered person in accordance with the relevant regulations, to ensure the safe and correct operation of the appliance.

Warning: - Before commencing any service or replacement of parts, turn off the gas supply to the fire.

- After servicing check for gas soundness.
- When ordering spare parts please quote appliance name and serial number these can be found on the data badge, which is located on the appliance, remove decorative front for access.
- If soot has accumulated check to establish cause, rectify and clean flue accordingly.

Important: - Refer to 'Health & Safety Notice (See Page 3) at the front of this booklet before removing the fuel bed components.

- Examine the coals for signs of cracking and replace if necessary.(IMPORTANT) see coal layout procedure in section four of this manual before attempting to replace coals, which should only be replaced as a complete set with no extra coals added.
- Check pilot aeration holes for linting, use a vacuum cleaner to remove any lint taking care not to damage the pilot head.

Replacement of Gas Control

1. Turn off the gas supply by the isolating cock.
2. Remove fire fret.
3. Remove Glass (See Section Four.)
4. Remove all loose fuel bed components.
5. Disconnect battery leads and remove appliance battery pack. Detach remote control eye from hearth. (See Section Seven when repositioning.)
6. Remove 2 screws fixing burner unit into the casing.
7. Disconnect fire at inlet elbow and remove burner unit from the casing.
8. Disconnect the thermocouple from the rear of the gas valve.
9. Undo the three compression nuts securing the pipes to the gas valve and remove the two screws fixing the valve to the bracket.
10. Clean, service or replace gas valve.
11. Re-assemble in the reverse order.
12. Turn on the gas supply, check for soundness and re-commission appliance.

Replacement of Injector

1. Remove the fret or fascia and turn off the gas supply by the isolation cock.
2. Remove the glass and fuel bed components as described earlier in this manual.
3. Undo and remove the 2 screw holding the burner in place
4. Carefully remove the burner lifting from the right hand end of the burner.
5. Loosen and remove the injector tip.
6. Clean or replace injector tip and replace in reverse order, ensuring that the connection to the injector fixing is sound air test if in doubt.
7. Turn on the gas supply, check for soundness and re-commission.

SECTION FOURTEEN Maintenance Instructions Continued

Replacement of the Thermocouple

1. Repeat operations 1-11 for removal of gas control.
2. Pull off the cable connections from the E.D.B. board.
3. Replace in reverse order.
4. Turn on the gas supply, check for soundness and re-commission.

Replacement of the Pilot Injector

1. Undo the pilot tube nut at the pilot bracket.
2. Pull the pipe gently back taking care not to damage.
3. Remove the pilot injector from inside the pilot bracket.
4. Clean or replace in reverse order, turn on the gas supply, check for soundness and re-commission.

REPLACEMENT OF CONTROL UNIT (EDB)

1. Repeat operations 1-7 for removal of gas control.
2. Disconnect leads from control unit and remove 4 bolts.
3. Re-assemble in the reverse order.

Turn on the gas supply, check for gas soundness and re-commission appliance.

When ordering parts quote 'PARAGON FOCUS RS PLUS REMOTE' and the serial number of the fire, which can be found on the data badge located behind the ash pan cover. (Refer to cleaning instructions for trim removal.)

Paragon Fires

Telford

Shropshire

TF3 3AR

Telephone 0845 5195991

Web Site www.paragonfires.co.uk

Paragon Fires

PARAGON FOCUS RS PLUS REMOTE

THIS IS YOUR EXTENDED FIVE YEAR PARTS WARRANTY

PLEASE READ IT CAREFULLY AND ENSURE YOUR INSTALLER HAS FILLED IN THE FIRST PORTION, KEEP IT IN A SAFE PLACE SO THAT IT IS AVAILABLE WHEN YOUR Gas Safe ENGINEER CARRIES OUT THE ANNUAL SERVICE.

THIS IN NO WAY REDUCES YOUR STATUTORY RIGHTS

**THE WARRANTY COMMENCES FROM THE DATE OF PURCHASE YOU MUST RETAIN YOUR RECEIPT OR INVOICE AS PROOF OF PURCHASE.
THIS EXTENDED WARRANTY SPECIFICALLY EXCLUDES SOFT REFRACTORY COMPONENTS, THE BULB AND ANY BATTERIES.**

Terms and Conditions

1. The appliance must be installed by a GAS SAFE registered person.
2. The appliance must be used in accordance with the users instructions.
3. The appliance must be serviced annually by a GAS SAFE registered person.
4. The service log must be correctly filled out and the record of annual services must be up to date and supported by receipts in each case.
5. This warranty is not transferable and relates to the original installation only.
6. The Registration Form must be correctly filled out and returned.
7. The appliance has not been subjected to misuse or accident or been modified or repaired by any person other than the authorised employee or authorised representative of Charlton and Jenrick Ltd.
8. The registration form must be returned within 3 months of purchase.

PARAGON HELPDESK NUMBER 0845 5195991

WARRANTY COVER

Important

For future reference we suggest you record the following details here, and keep the receipt as proof of purchase. This information may be asked for when you contact the helpdesk.

Model: **PARAGON FOCUS RS PLUS REMOTE** **Serial No.**

This information can be found on the label attached to the packaging and on the data badge, which is located on the appliance, remove decorative front for access.

Retailer Name: _____

Address: _____

Purchase date :

Service Log

The following information must be complete and supported by receipts as part of the conditions of the extended three year parts warranty and the appliance must be registered by completing and returning the registration document (last page of this booklet) to Paragon Fires.

Date of First annual service:

Engineer Name _____

Gas Safe Registration No.

Date of Second annual service:

Engineer Name _____

Gas Safe Registration No.

Date of Third annual service:

Engineer Name _____

Gas Safe Registration No.

Date of Fourth annual service:

Engineer Name _____

Gas Safe Registration No.

We may introduce modifications to products from time to time, and consequently the details given in this booklet are subject to alteration without notice.

Paragon Fires

Telford
Shropshire
TF3 3AR

Telephone 0845 5195991
Web Site www.paragonfires.co.uk

PLEASE REGISTER YOUR 12 MONTH WARRANTY WITH US TODAY

Simply detach this sheet from this booklet, complete and return it in a stamped addressed envelope to:

PARAGON FIRES
Charlton and Jenrick Ltd
UNIT D
STAFFORD PARK 2
TELFORD
SHROPSHIRE
TF3 3AR

YOUR DETAILS

Name _____

Address _____

Post Code TELEPHONE No.

PRODUCT DETAILS

Model: **PARAGON FOCUS RS PLUS REMOTE**

Serial No. _____

Date of Purchase

This information can be found on the label attached to the packaging and on the data badge, which is located on the appliance, remove decorative front for access.

WHERE DID YOU PURCHASE THIS PRODUCT

Name _____

Address _____

Post Code TELEPHONE No.

Paragon Focus RS Plus Remote Coal

Product ID Label	A-0285	Serial No Prefix	MF
Data Badge			
Burner Tray / Box Assembly			
Air Test Completed			
Warning Label (Fire Guard)			
High Rate Injector Tip 1 x 360 (5867)			
Low Rate Injector Tip 1 x 220 (5868)			
Copper Washer			
Installation Seal			
Fixing Kit (0705)			
Wall Clamp Bracket			
7mm Spanner (5243)			
Magnets (4 x 3048)			
Remote Control Handset			
Self Adhesive Clip Aluminium			
Battery AA (12) And 9v Battery			
Battery Holder (with lead)			
Glass Assembly			
Canopy 4540			
Flue Assembly And (4 x S/S Screws)			
Terminal Guard And Flue Pipe			
Wall Gasket			
Doughnut Seal (2)			
Serial Number			
Inspector			