

# Owner's Manual

INCLUDES

User, Maintenance, Service, and Installation  
Instructions



## Focus RS PLUS Manual Version



(2 x INJECTOR TIPS SUPPLIED WITH THIS APPLIANCE)

5.4kw – 2.4kw INJECTOR & 3.8kw – 2.4kw INJECTOR

Keep this booklet for service log and future reference

### IMPORTANT



This appliance is guaranteed for 12 months subject to conditions. The 5 year extended parts warranty will only be valid if the annual service recommended in this manual has been completed and appliance has been registered online.

For use in Great Britain and Ireland.

Literature NO 5941 (ISS 5)

## Contents

EXTENDED FIVE YEAR PARTS WARRANTY .....	2
Benchmark Scheme .....	3
<b>SECTION ONE Important Information (user instructions).....</b>	<b>5</b>
<b>SECTION TWO Introduction (user instructions) .....</b>	<b>7</b>
<b>SECTION THREE Operation (user instructions) .....</b>	<b>7</b>
<b>SECTION FOUR Cleaning &amp; Fuel Bed Laying (user instructions).....</b>	<b>8</b>
<b>SECTION FIVE Replacement Parts (user instructions) .....</b>	<b>16</b>
<b>SECTION SIX Appliance Data (installation instructions).....</b>	<b>16</b>
<b>SECTION SEVEN Regulations and Warnings (installation instructions).....</b>	<b>18</b>
<b>SECTION EIGHT Siting the Appliance (installation instructions).....</b>	<b>19</b>
<b>SECTION NINE Preparing the Appliance for Installation (installation instructions) .....</b>	<b>20</b>
<b>SECTION TEN To Install the Appliance (installation instructions).....</b>	<b>21</b>
<b>SECTION ELEVEN Assemble the Appliance (installation instructions) .....</b>	<b>26</b>
<b>SECTION TWELVE Check Operation of Fire (installation instructions).....</b>	<b>27</b>
<b>SECTION THIRTEEN Instruct and Advise the Customer (installation instructions).....</b>	<b>27</b>
<b>SECTION FOURTEEN Maintenance Instructions (maintenance instructions).....</b>	<b>28</b>
BALANCED FLUE GAS FIRE COMMISSIONING CHECKLIST .....	34
SERVICE RECORD.....	35



## EXTENDED FIVE YEAR PARTS WARRANTY

In order to validate your extended 5 years parts warranty please read the Benchmark Scheme on the opposite page and ensure your installer has filled in the appropriate checklist.

**This in no way reduces your statutory rights**

Your warranty commences from the date of purchase and you must retain your receipt or invoice as proof of a purchase date.

THIS EXTENDED WARRANTY SPECIFICALLY EXCLUDES GLASS AND SOFT REFRACTORY COMPONENTS, THE BULB AND ANY BATTERIES.

### Terms and Conditions

1. The appliance must be installed by a GAS SAFE registered person.
2. The appliance must be used in accordance with the user's instructions.
3. The appliance must be serviced annually by a GAS SAFE registered person.
4. The benchmark and service log must be correctly filled out and the record of annual services must be up to date and supported by receipts in each case.
5. This warranty is not transferable and relates to the original installation only.
6. The appliance has not been subjected to misuse or accident or been modified or repaired by any person other than the authorised employee or authorised representative of Charlton and Jenrick Ltd.
7. The registration form must be returned within 1 month of purchase.

**Technical Help Desk 01952 200 444**

## Benchmark Scheme



Charlton and Jenrick Ltd is a licensed member of the Benchmark Scheme which aims to improve the standards of installation and commissioning of domestic heating and hot water systems in the UK and to encourage regular servicing to optimise safety, efficiency and performance. Benchmark is managed and promoted by the Heating and Hotwater Industry Council. For more information and the full code of practice please visit [www.centralheating.co.uk](http://www.centralheating.co.uk)

Please ensure that the installer has fully completed the Benchmark Checklist on the inside back pages of the installation instructions supplied with the product and that you have signed it to say that you have received a full and clear explanation of its operation. The installer is legally required to complete a commissioning checklist as a means of complying with the appropriate Building Regulations (England and Wales).

All installations must be notified to Local Area Building Control either directly or through a Competent Persons Scheme. A Building Regulations Compliance Certificate will then be issued to the customer who should, on receipt, write the Notification Number on the Benchmark Checklist.

This product should be serviced regularly to optimise its safety, efficiency and performance. The service engineer should complete the relevant Service Record on the Benchmark Checklist after each service.

The Benchmark Checklist will be required in the event of any warranty.

It is a requirement that the gas fire is installed and commissioned to the manufacturer's instructions and the data fields on the commissioning checklist completed in full.

To instigate the guarantee, the gas fire needs to be registered with the manufacturer within one month of the installation.

To maintain the guarantee, it is essential that the gas fire is serviced annually by a Gas Safe registered engineer. The service details should be recorded on the Benchmark Service Interval Record and left with the householder.

## **Important**

For future reference we suggest you record the following details here, and keep the receipt as proof of purchase. This information may be asked for when you contact the helpdesk.

<b>MODEL:</b>	<b>Paragon RS PLUS MANUAL</b>	<b>Serial No.</b>	
---------------	-------------------------------	-------------------	--

This information can be found on the label attached to the packaging and on the data badge, which is located on the base of the appliance behind the control cover.

<b>Retailer Name:</b>	
<b>Address:</b>	
<b>Date Of Purchase:</b>	

## **Installer information required to register for the extended warranty**

<b>Name:</b>	
<b>Date of installation:</b>	
<b>Gas safe number:</b>	

## SECTION ONE Important Information (user instructions)

### **Consumer protection information**

As manufacturers and suppliers of heating products, we take every care, as far as is reasonably practicable, that these products are so designed and constructed as to meet the general safety requirement when properly used and installed. To this end, our products are thoroughly tested and examined before despatch.

**IMPORTANT NOTICE:** Any alteration that is not approved by the appliance manufacturer could invalidate the approval of the appliance, operation of the warranty and could affect your statutory rights.

### **Health and safety notice**

#### **Important**

This appliance could contain some of the materials, indicated below, that could be interpreted as being injurious to health and safety. It is the users / installers responsibility to ensure that the necessary personal protective clothing is worn when handling these materials, see below for information.

**Artificial Fuels, Mineral Wool, Insulation Material, Refractory/Ceramic Fibres, Glass Yarn** - *may be harmful if inhaled, may be irritating to skin, eyes, nose and throat.*

**When handling** *avoid inhaling and contact with skin or eyes. Use disposable gloves, facemasks and eye protection. After handling wash hands and other exposed parts. If a vacuum is used for cleaning the coals or cleaning after servicing / installation it is recommended that it be of the type fitted with a HEPA filter.*

**Disposal of refractory/ceramic materials.** *To keep dust to a minimum these materials should be securely wrapped in polythene and be clearly labelled 'RCF waste'. These materials are not classified as 'hazardous waste' and should be disposed of at a site licensed for the disposal of industrial waste.*

- The PARAGON FOCUS RS PLUS is an inset room sealed decorative fuel-effect gas appliance.
- The PARAGON FOCUS RS PLUS is available in **Natural Gas (G20 @ 20 mbar) Only**. The marking (**G20** for natural gas) on the packaging and the data badge specify the gas for which the appliance has been factory set. **Note: These appliances should only be used on the appropriate gas specified.**
- The PARAGON FOCUS RS PLUS **must not** be installed into a natural draught flue or chimney.
- Failure to install appliance correctly could lead to prosecution.
- In GB (Great Britain), the appliance must be installed and serviced by a competent person i.e. Gas Safe registered, in accordance with the GAS SAFETY (INSTALLATION AND USE) REGULATIONS, The Building Regulations (or The Building Regulations (Scotland) or The Building Regulations (Northern Ireland)) and The Current I.E.E. Wiring Regulations, if appropriate.

In IE (Ireland), the appliance must be installed and serviced by a competent person and installed in accordance with the current edition of I.S.813 Domestic Gas Installation, the current Building Regulations and the current ETCI rules for electrical installation, if appropriate.

- The PARAGON FOCUS RS PLUS does not require a chimney, but **must be** installed against an outside wall.
- It is important that the flue terminal is regularly checked and kept clear at all times.
- If the terminal is accessible to people (i.e. less than 2m above a walkway, balcony etc.) the terminal guard must be fitted to prevent access to the flue outlet, which becomes hot when the fire is in use.
- All combustible material must be removed from behind the fire and fire trim.

- As the PARAGON FOCUS RS PLUS is a room sealed appliance (i.e. air for the combustion process is taken from outside the room) no purpose built ventilation is required.
- The PARAGON FOCUS RS PLUS is designed and tested to meet the requirements of the European Standard EN 613.
- Although the PARAGON FOCUS RS PLUS is fitted with a glass front which acts as a dress guard it is strongly recommended that a fireguard should be used for the protection of children, the elderly or infirm. Fireguards should conform to B. S. 6539 (1984) (Fireguards for use with solid fuel appliance).
- The slot located at the top of the PARAGON FOCUS RS PLUS are the hot air outlets and as such must not be obstructed in any way (particularly by clothes or other combustibles). In addition such items should not obstruct the base of the appliance as this may adversely affect the performance of the appliance.
- Care should be taken to prevent any damage being caused to surrounding soft furnishings or decoration. Many wall coverings may become discoloured if placed too close to the appliance, it is strongly recommended that any proposed wall covering intended for use immediately above the appliance should be tested in the hottest position (immediately above) first. Run the fire on high over a few days
- The first time you light your new appliance a smell may occur due to its new condition. This is quite normal and will soon disappear after a few hours use at maximum setting (open a window until the smell disappears).
- The appliance **MUST NOT** be used if the glass panel is not correctly fitted or if this panel is cracked or broken.
- Any debris should be cleaned from the appliance. A vacuum cleaner can be used but only after all the loose coals have been removed.
- **Prior to removing or cleaning the fuel bed components refer to the 'Health and Safety Notice' located on page 3 of this booklet.**
- The appliance should be serviced annually by a competent person i.e. a **Gas Safe registered engineer** in accordance with these instructions.
- The glass or any part of the appliance **MUST NOT** be cleaned or wiped whilst the appliance is **HOT**, to do so could be dangerous and may damage the paintwork of the appliance.
- The cast fire front or Fascia casing **MUST BE** positioned in front of the fire whilst it is burning.
- A where a fire front (fret) is used with this appliance it must conform to the following:
- It must be made from non-combustible material.
- Its general construction should enable it to stand firmly across the full width of the burner.
- The design of the fire front (fret) must have a removable ashtray cover (lower section).
- The ash tray cover must have cut outs and or holes which provide ventilation to the underside of the burner.
- The effective area of ventilation through the ash tray cover must be greater than 1365mm<sup>2</sup> (2.12 sq. ins.)

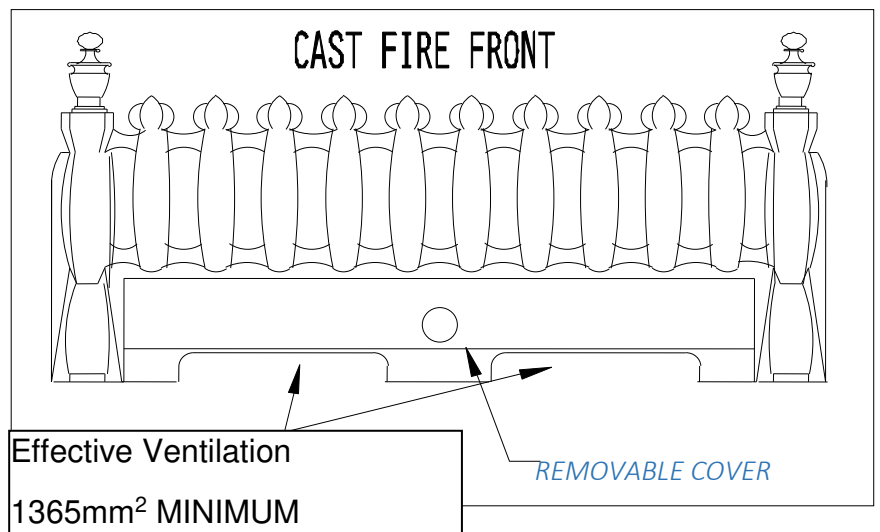

## SECTION TWO Introduction (user instructions)

- The PARAGON FOCUS RS PLUS is an inset room sealed live fuel-effect gas appliance designed for use in locations that do not have a conventional chimney. The appliance must be installed against an outside wall because the air to support combustion is taken from the outside and the products of combustion are expelled to the outside.
- The appliance incorporates a safety device in the form of a FLAME SUPERVISION DEVICE, which constantly monitors the flame and will cause the gas to be switched off if the flames are extinguished for any reason. **THIS DEVICE MUST NOT BE OVERRIDDEN.** If this situation occurs on a regular basis have the appliance checked by a qualified engineer. The problem may be due to a blocked or restricted flue.
- Before removing the fret, trim, glass or fuel bed for cleaning the fire should be turned off, and left to cool down.
- **NOTE:** In use some discoloration of the components will take place in the combustion box, this is normal, but can be kept to a minimum if the coals are placed correctly (i.e. after cleaning). See Section 4.
- As with all heating appliances certain areas (Working Surfaces) become very hot when the appliance is in use. Only the ashpan knob and the gas control knob should be touched when the fire is being used.

## SECTION THREE Operation (user instructions)

Do not use this appliance without the glass panel fitted, or if this panel is cracked or broken.







**WARNING:** If the burner or pilot is extinguished for any reason, do not attempt to re-light the pilot for at least three minutes.

### LIGHTING THE FIRE

The pilot can be left on or the pilot can be extinguished and relit each time the fire is used.

The appliance Control Knob is positioned behind the fret or fascia panel.

*The full lighting procedure for MANUAL VERSION is as follows: -*

- Push knob in as far as possible on gas control.
- Turn knob anti-clockwise until a click is heard. The knob will stop at the position marked  and a spark should be seen at the tip of the ignition probe. At the same time the pilot flame should light. **KEEP THE KNOB PRESSED IN FOR 20 SECONDS.** Should the pilot fail to light, turn the control knob clockwise to the  position, wait 3 minutes, and repeat the procedure.
- After lighting the pilot flame the control knob should be allowed to spring out slightly. This will allow you to turn the knob further anti-clockwise to the position marked . The pilot flame should then ignite the main fire.
- It is possible to adjust the height of the flames by turning the control knob between the positions marked  and . Note that the knob 'latches' in position at either end of this movement and must be pushed in slightly before it can be turned.
- To turn the fire off, depress the knob slightly and turn it to the  position.
- To completely extinguish the fire, depress the knob slightly and turn to  the position.

## SECTION FOUR Cleaning & Fuel Bed Laying (user instructions)

**Warning:** -Before you clean any part of the appliance ensure that the appliance is switched off and cold.

### CLEANING: DECORATIVE TRIM

- The Decorative finish of the trim is coated with a high temperature lacquer, it should be wiped with a soft, clean, dry, cloth only.
- The trim should be removed for cleaning. The fret should be removed before removing the trim, which is held in place by four magnets.

### CLEANING: BLACK PAINTED SURFACES

- These surfaces should be dusted regularly and any marks removed with a soft cloth.
- Abrasive or chemical cleaner should never be used.

### CLEANING: GLASS PANEL

From time to time it may be necessary to clean the glass panel.

We recommend you use a Ceramic Hob Cleaner (brands such as **HOB BRITE** and **VITRO CLEAN** have been found to be **acceptable**) these are available from most leading Supermarkets.

Remove the glass panel as follows:

- Remove ash pan cover and fret.
- Remove decorative trim (held in place with four magnets).
- Remove the 2 nuts that hold the fret cover on, and remove fret cover.
- Slacken but **do not remove** the 4 nuts securing the glass frame.
- Remove the 2 nuts located on the bottom of the glass frame. **Note:** when it is replaced ensure the glass is central and that all the four studs pass through the slots in the glass frame.
- While supporting the glass panel, remove the 2 nuts securing the sides of the glass frame, remove the glass frame and slide it out gently.
- Lay the glass panel down on a flat working surface on top of an old opened newspaper with the side to be cleaned uppermost **take care not to erase the dot printing in the cleaning process.**

Follow the Instructions on the Hob Cleaner Bottle.

On stubborn stains (where the appliance has been used for a long period without glass panel being cleaned), use a new Brillo Pad well wetted with the Hob cleaner applied directly to it.

Ensure all the residues of the cleaner are removed with a damp cloth and the glass panel is completely dry before fitting to the appliance.

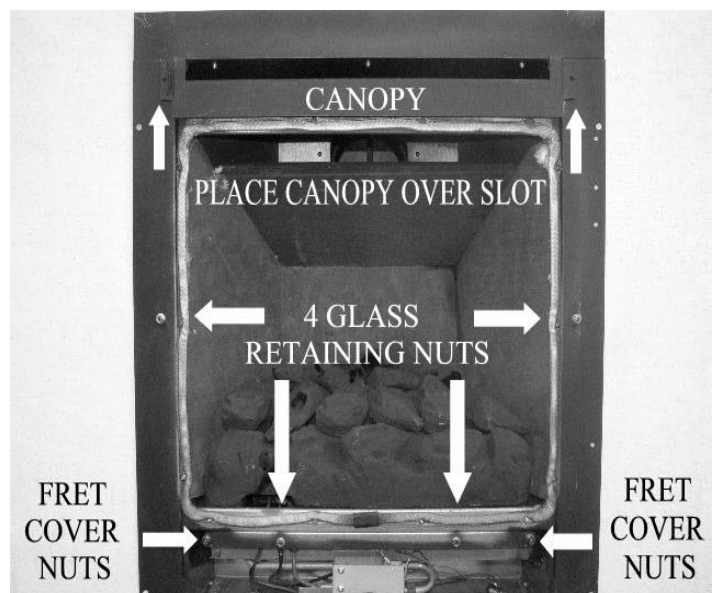



Note: - If the fuel bed has not been placed correctly, causing the gas flame to contact the glass this may result in glass staining that cannot be removed by cleaning.

Re-assemble in reverse order ensuring the seal is compressed evenly at the top and bottom

Re-fit the top outlet grill before re-fitting the trim and fret and before re-lighting.

### **CLEANING AND REPLACING Fuel Bed Parts**

**Important: - Refer to the 'Health & Safety Notice located on page 3 of this booklet before cleaning or replacing any refractory material.**

**Use only the Fuel Bed part provided NO OTHER FUEL BED PARTS SHOULD BE ADDED to the appliance**

**If any Fuel Bed Parts are broken then they must be replaced before the appliance is used.**

**Note:- There are two possible fuel bed arrangements**

**COAL or PEBBLE**

**Please check the label on the appliance carton to ensure you have the correct fuel bed**

The fuel bed parts are delicate and should be handled with great care.

The loose part should be removed for cleaning. They can be brushed very gently with a soft brush to remove dust or any deposits.

A vacuum cleaner may only be used after all the loose coals have been removed.

**NOTE: During operation some sooting will be evident on the fuel bed whether running on the high or low setting. This may be reduced by running on the opposite setting for 15 minutes prior to switching the fire off i.e. If fire is running on high then turn to low for 15 minutes before turning off. This will not eliminate all soot but helps keep it to a minimum.**

## **COAL BED LAYOUT**

- The Coal set as shown consists of:

Rear Matrix

Front Matrix

10 x Individual Coals



- The Front Matrix is located as shown in front of the burner



- The Rear Matrix is located so that it fits behind the burner (ensure it is not placed over the burner)



- When positioning the rear matrix be careful not to cover the burner ports

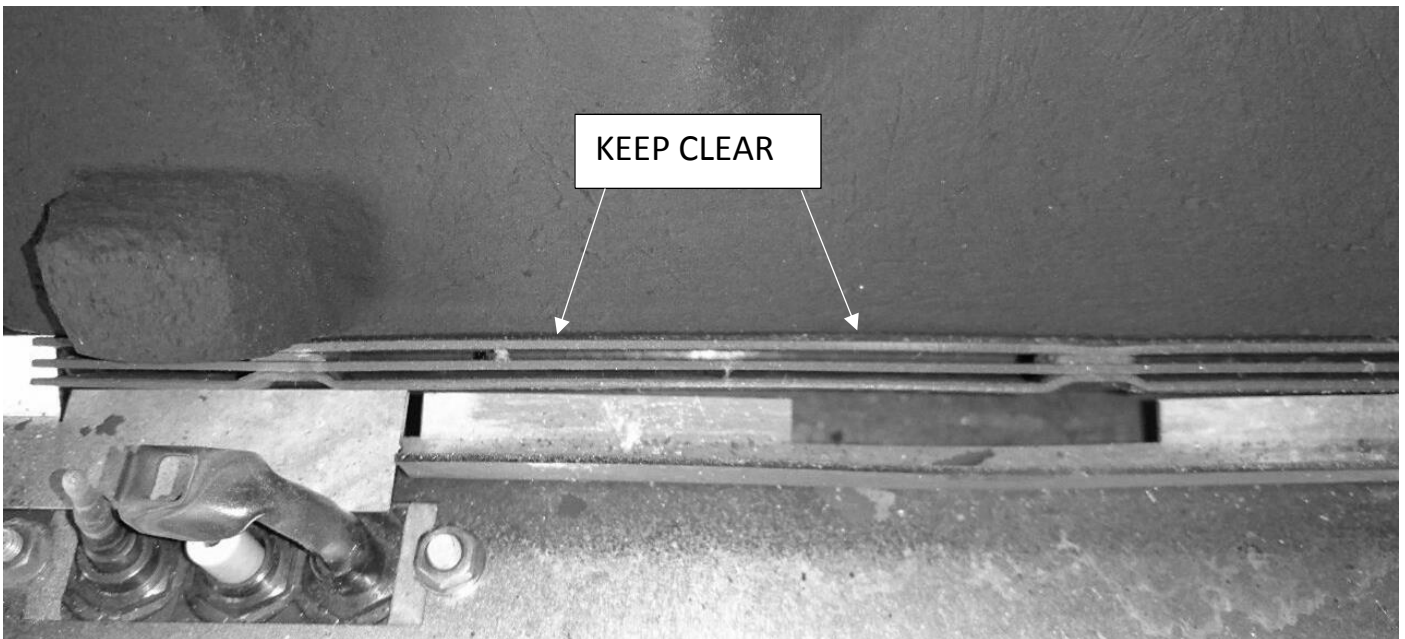



- Insert back row of 4 coals as shown.



- Complete front row of 6 coals as shown.
- That completes the coal bed assembly
- Go to section eleven to complete the appliance assembly
- Ensure the glass panel and other associated parts are fitted before lighting the appliance

The Pebble set as shown consists of:

- Front Matrix
- Rear Matrix
- 3 x "No 2 Shape" Pebbles
- 6 x "No 4 Shape" Pebbles



- The Front Matrix is located as shown in front of the burner

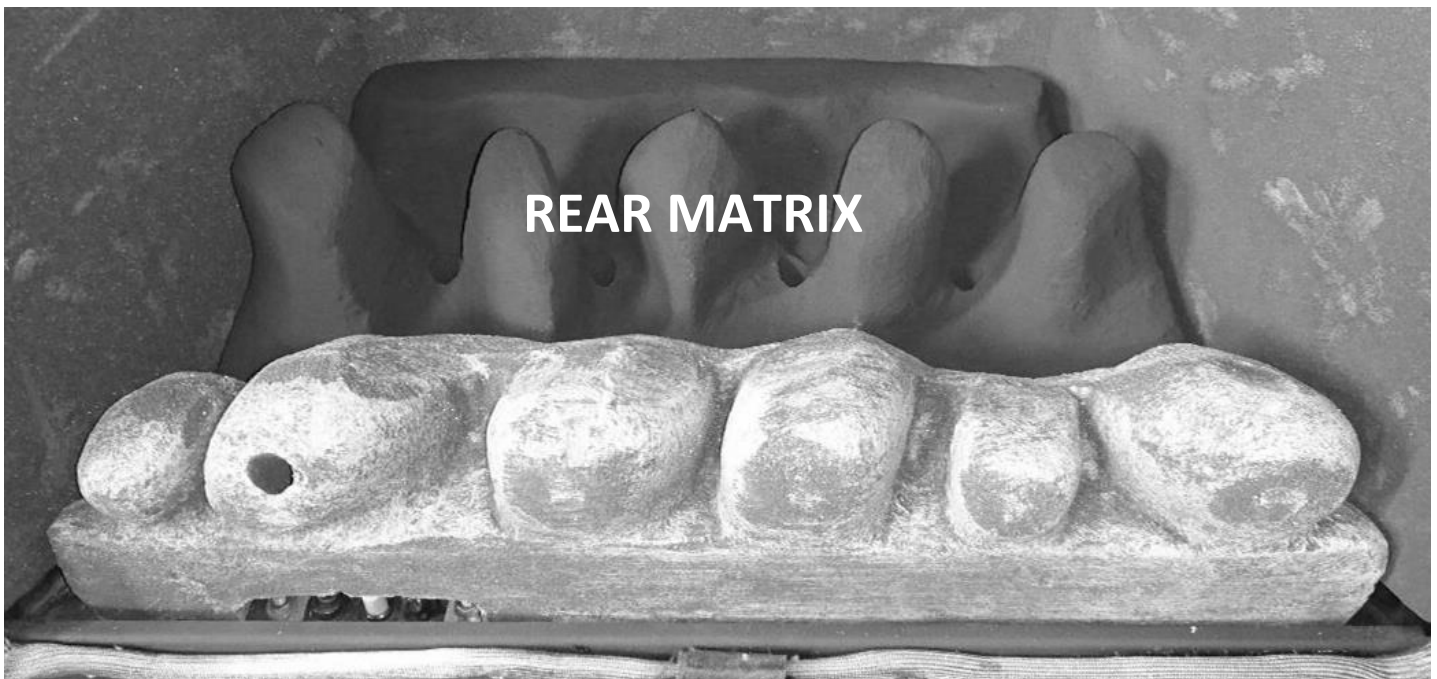

- The Rear Matrix is located so that it fits behind the burner (ensure it is not placed over the burner)



- When positioning the rear matrix be careful not to cover the burner ports

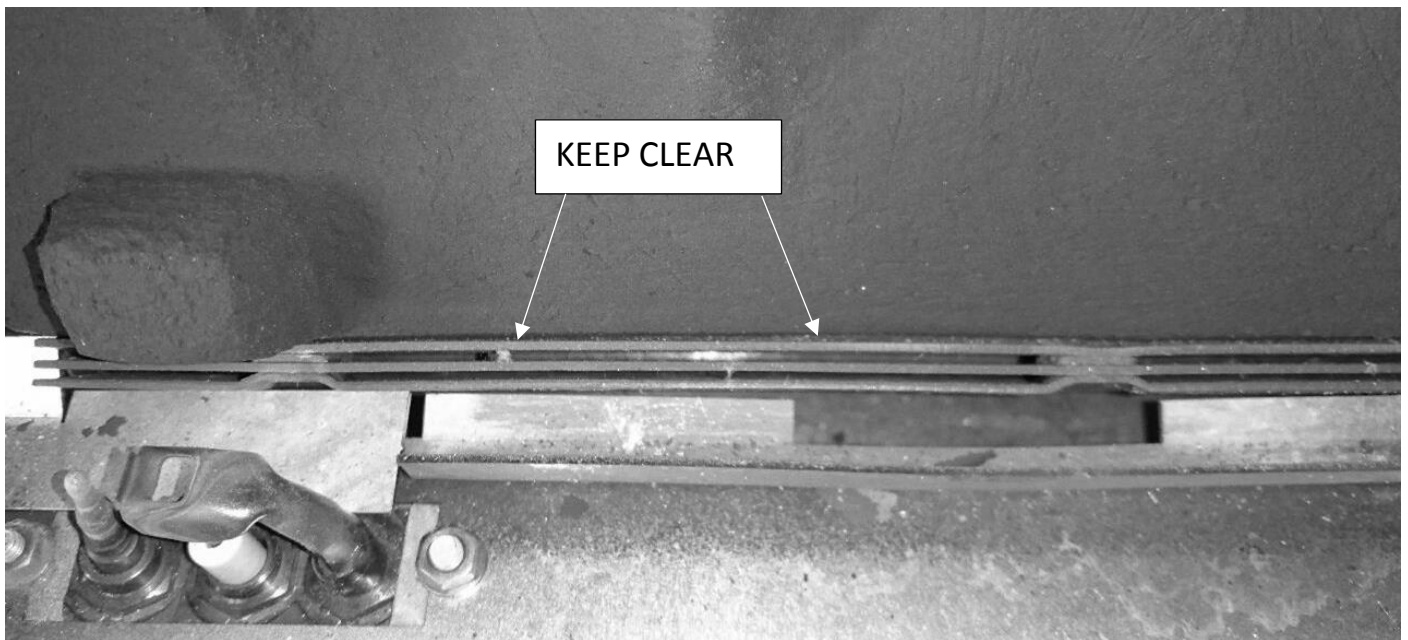



- Position the front row of “No 4” & “No 2” shape pebbles as shown.



- Finally position the remaining 4 x “No 4” shape pebbles as shown.
- That completes the pebbles bed assembly
- Go to section eleven to complete the appliance assembly
- Ensure the glass panel and other associated parts are fitted before lighting the appliance

## SECTION FIVE Replacement Parts (user instructions)

The only user removable parts are: -

- Cast fret
- Top Outlet Grill
- Glass panel frame and fret apron
- Decorative Trim
- Refractory fuel bed components

## SECTION SIX Appliance Data (installation instructions)

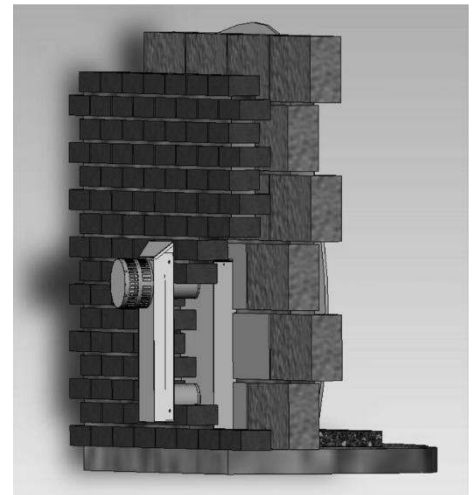
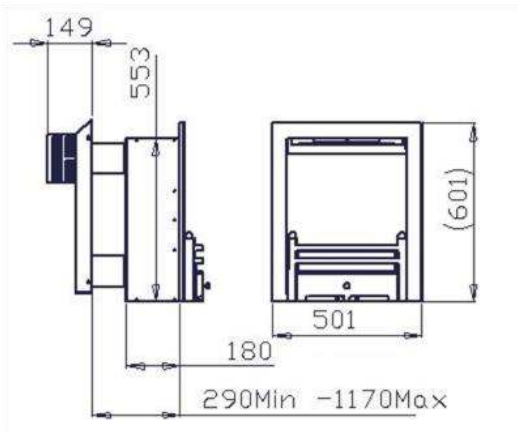

Wall Cut-out dimensions:	Height	553mm
	Width	405mm
Overall dimensions:	Height	601mm
	Width	501mm
Forward Projection:	90mm, (From fireplace opening Including typical fret.)	
Weight:	38.5kg (Boxed excluding fret) 37kg (Unboxed excluding fret)	
Flue Length and duct length:	100mm (minimum) to 1 metre (maximum)	
Standard length supplied with fire-535mm (267mm after cutting). Additional 535mm & 1m tubes supplied as optional extras. (No bends should be fitted in the flue pipe)		
Injector Tips x 2:	1x 360 tip ( 5.4kw )fitted &1x 220 tip ( 3.8kw )supplied	
Pressure Test Point Location:	Gas inlet elbow	
Gas Connection:	8.0mm O/D, tube.	
Data Badge Location:	On the appliance behind decorative front.	



MODEL	N G(G20) Version 5.4 inj	N G (G20) Version 3.8 inj
Category of appliance	C <sub>II</sub>	C <sub>II</sub>
NO <sub>x</sub> Class	3	3
Efficiency Class	1	1
Gas Category	I <sub>2H</sub>	I <sub>2H</sub>
Gas Type	G20 Natural Gas	G20 Natural Gas
Gas Pressure +/- 1.0mbar	20 mbar	20 mbar
Gas Input (Max)	5.4 kW Gross	3.8 kW Gross
(Min)	2.4 kW Gross	2.4kW Gross
Injectors size	360	220

*NOTE: The efficiency of this appliance has been measured as specified in BS EN613-2001 and the result is 79.14.% for 5.4kw & 75.68.% for 3.8kw natural gas The gross calorific value of the fuel has been used for this efficiency calculation. GasTec have certified the test data from which it has been calculated. The efficiency value may be used in the UK Government's Standard Assessment Procedure (SAP) for energy rating of dwellings.*

## SECTION SEVEN Regulations and Warnings (installation instructions)

- **THIS APPLIANCE MUST ONLY BE INSTALLED IN GREAT BRITAIN OR IRELAND.**
- **THE APPLIANCE IS AVAILABLE IN NATURAL GAS only.**
- **CONFIRM THAT THE APPLIANCE IS SUITABLE PRIOR TO INSTALLATION (G20 FOR NATURAL GAS) (REFER TO DATA BADGE ON BASE OF APPLIANCE). *NOTE: THE APPLIANCE SHOULD ONLY BE USED ON THE APPROPRIATE GAS SPECIFIED. IT IS NOT SUITABLE FOR CONVERSION FROM ONE GAS TO THE OTHER.***
- **THIS APPLIANCE MUST BE INSTALLED ON A SUITABLE OUTSIDE WALL.**
- **NO SPECIAL VENTILATION BRICKS OR VENTS ARE REQUIRED INTO THE ROOM CONTAINING THE APPLIANCE.**
- **IT IS THE LAW THAT ALL GAS APPLIANCES MUST BE INSTALLED BY A COMPETENT PERSON; I.E. A GAS SAFE REGISTERED INSTALLER, IN ACCORDANCE WITH THE CURRENT GAS SAFETY (INSTALLATION AND USE) REGULATIONS 1994 (AS AMENDED), ALL RELEVANT PARTS OF THE LOCAL AND NATIONAL BUILDING REGULATIONS AND ALL RELEVANT RECOMMENDATIONS OF THE CURRENT BRITISH STANDARDS. FAILURE TO DO SO COULD LEAD TO PROSECUTION.**

THE FOLLOWING ARE THE RELEVANT CODES OF PRACTICE AND BRITISH STANDARDS: -

B.S. 5871 PART 2

B.S. 5440 PART 1

B.S. 6891

B.S. 1945

Note:- This appliance must be installed to current versions of the above standards and include any relevant amendments.

THE BUILDING REGULATIONS ISSUED BY THE DEPARTMENT OF THE ENVIRONMENT.

THE BUILDING STANDARDS (SCOTLAND) (CONSOLIDATED) REGULATIONS ISSUED BY THE SCOTTISH DEVELOPMENT OFFICE.

PRIOR TO THE INSTALLATION ENSURE THAT THE LOCAL DISTRIBUTION CONDITIONS (IDENTIFICATION OF TYPE OF GAS AND PRESSURE) AND ADJUSTMENT OF THE APPLIANCE ARE COMPATIBLE. (G20 @ 20mbar Natural Gas Version)

### **warnings**

- As this appliance has components, which get very hot as with all such fires, it is recommended that a fireguard should be used for the protection of children, the elderly, or the infirm. Fireguards should conform to B.S.6539 (1984) (Fireguards for use with solid fuel appliances).
- During initial use, an odour may be evident. This will soon disappear if the fire is run on its maximum setting for a few hours.
- Care must be taken to prevent any damage being caused to surrounding soft furnishing or decoration, e.g. wall coverings may become discoloured if placed too close to the appliance.

### **IMPORTANT NOTES**

- This appliance is a fuel effect gas fire designed for use in locations that do not have a conventional chimney.

## SECTION EIGHT Siting the Appliance (installation instructions)

(When installing in a timber framed dwelling reference must be made to the specific installation requirements stated in **Section 10 Installing the Appliance in Timber Framed Dwelling**).

**THERE ARE TWO TYPES OF INSTALLATION** (into conventional masonry walls): -

- The appliance body can be recessed back into the brickwork cavity so that the appliance is flush fitting with the wall or fireplace back panel, see Installation Instructions,

**OR**

- With a dummy chimneybreast constructed forward into the room to take up the 180mm depth of the firebox. This depth can be reduced if a deep rebated surround is also used the rebate depth can be deducted from the dummy breast depth any surround used must meet the specification stated later in this section. Prior to installing the appliance all combustible materials must be removed from the rear faces as described in Section 10.

### GENERAL REQUIREMENTS

- The flue and air duct length must be between 100mm to 1metre. The fire is supplied with a standard pipe length of 535mm (to be cut in half to make a flue and air duct length of 267mm) The flue and air duct must not accommodate any bends. Other lengths of flue and air duct are available
- The flue outlet must terminate on a suitable outside wall.
- The minimum flue terminal clearances, which must be maintained, are as shown below.

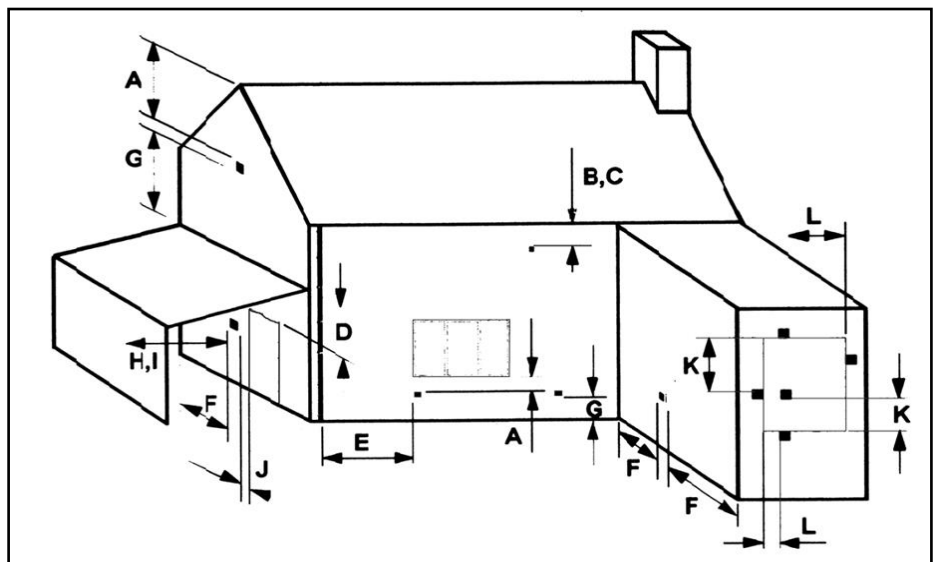

A. Directly below an openable window or other opening. E.g. air brick.....	300mm
B. Below gutters, soil pipes or drain pipes.....	300mm
C. Below eaves.....	300mm
D. Below balconies or car port roofs.....	600mm
E. From vertical drain pipes and soil pipes.....	75mm
F. From internal and external corners.....	300mm
G. Above ground, roof or balcony level.....	370mm
H. From a surface facing the terminal.....	600mm
I. From a terminal facing the terminal.....	1200mm
J. From an opening in a car port into a dwelling e.g. door, window, etc.....	1200mm
K. Vertically from a terminal on the same wall.....	1500mm
L. Horizontally from a terminal on the same wall.....	300mm

**Note: These dimensions are taken from the center of the circular flue outlet.**

**\*To minimise the risk of cracking due to heat expansion the use of a 3 – piece back panel is recommended\***

- The back panel of the surround must have a cut-out within the maximum and minimum dimensions as shown.
- Ensure that gas supply is suitably sited.
- A non-combustible hearth must be provided beneath the appliance if the appliance is fitted at low level (less than 150mm from floor). The hearth must have a minimum thickness of 12mm and the perimeter 50mm above floor level. The hearth must extend the full width of the appliance and must project forward a minimum of 100mm in front of the appliance.
- Alternatively the appliance may be fitted without a hearth (Hole in the Wall type installations), 150mm min. from the floor to the base of appliance

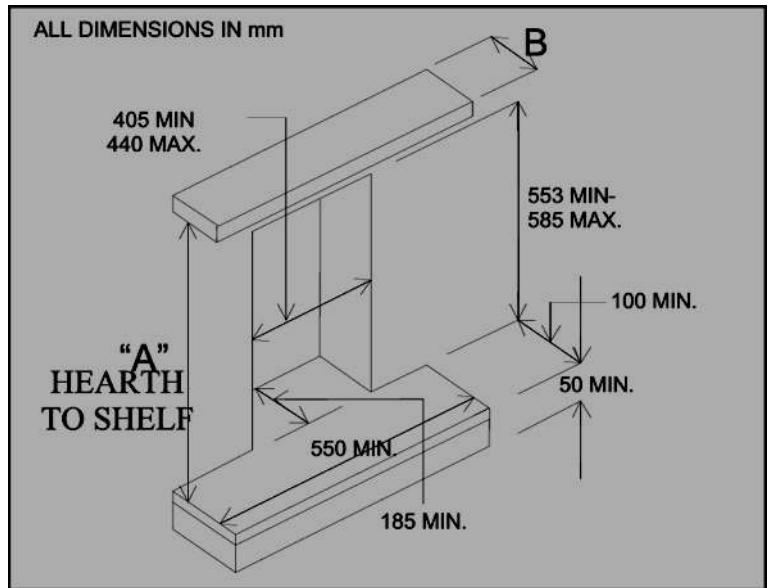

- The minimum clearance from the hearth (base of appliance) to the underside of a combustible shelf should be determined using the shelf chart.
- Minimum width between vertical sides of combustible surround should not be less than 800 mm provided fire is central to the surround and sides do not project more than 150 mm. When vertical side forward projection is increased by 12.5 mm add 50 mm to inside width of surround.
- Check with the supplier or manufacturer that the surround meets 150°C minimum rating (attention should especially be given to man made materials such as resin).
- When installing in a timber framed dwelling reference must be made to the specific installation requirements stated in **Section 10 Installing The Appliance In Timber Framed Dwelling.**

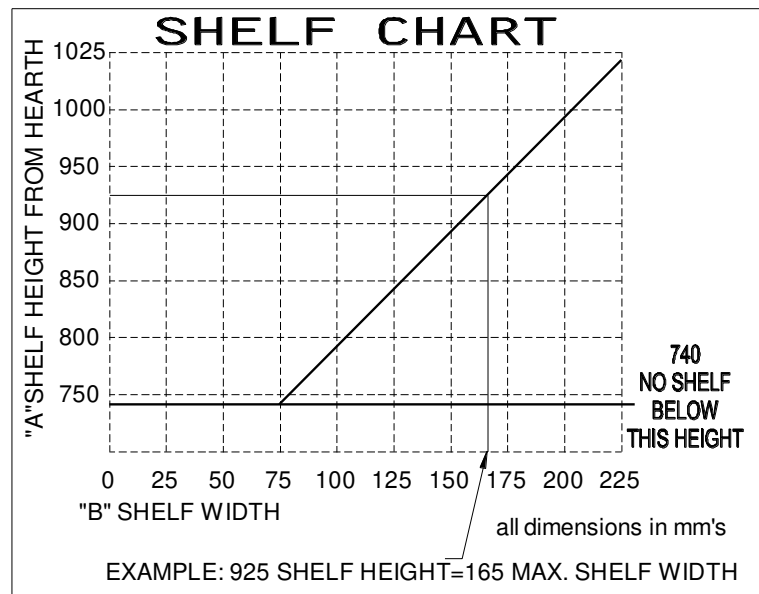

**\*Please note - Appropriate measures should be taken when installing into a working flue system i.e. out through an existing chimney \***

## SECTION NINE Preparing the Appliance for Installation (installation instructions)

- Carefully unpack the appliance from the carton and check the contents.
- Lift off the decorative trim, which is held by four magnets and put to one side.
- Lift away the fascia grill unit, which hooks over the lip of the combustion chamber.
- Lay the appliance on its back ensuring suitable protection is provided for the carpet / floor.
- Remove the two cross head nuts securing the fret apron and remove the apron
- Remove the 2 nuts located on the bottom of the glass frame. **Note:** when it is replaced ensure the glass is central and that all the four studs pass through the slots in the glass frame.
- Remove the 2 nuts securing the sides of the glass frame, remove the glass frame and slide it out gently.
- Remove the refractory components from the inside of the appliance.
- The appliance is now ready for installation.

## SECTION TEN To Install the Appliance (installation instructions)

### INSTALLING THE APPLIANCE INTO CAVITY WALL (When installing in a timber framed dwelling reference must be made to the specific installation requirements stated later in this Section 'Installing The Appliance In Timber Framed Dwelling').

- Ensure it is a suitable outside wall constructed of non-combustible materials and that the flue position meets the requirements previously described in **Section 8**.
- Mark a horizontal line on the wall at the intended hearth surface or appliance base height (50mm min for Hole in Wall installation (the skirting board must be cut away from behind the fire).
- Mark a vertical line on the wall at the intended centre of the appliance up from the horizontal line for a height of 555mm.
- Mark two more vertical lines 202mm either side of the centre line for a height of 555mm.
- Mark a horizontal line at a height of 555mm above the hearth line, joining the two outside lines together.

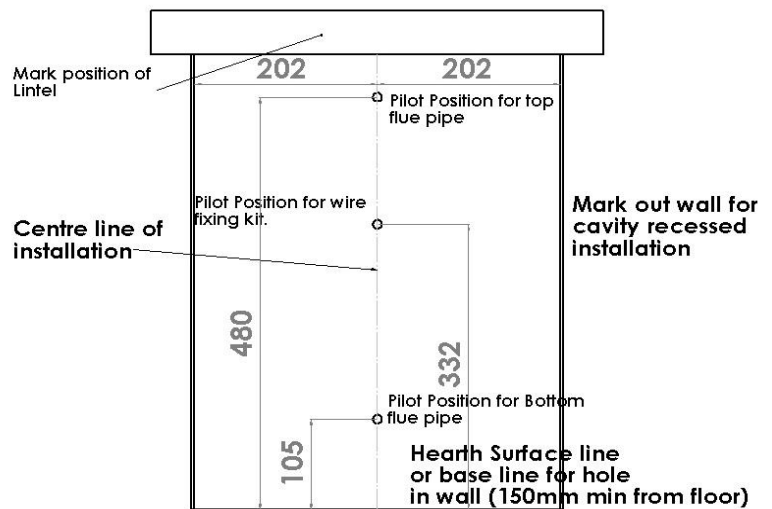

- Mark the position for a lintel above the top horizontal line.
- Mark three short horizontal lines so they cross the centre line, one at 105mm, one at 332mm and one at 480mm above hearth level line. These are the centre points for the air duct, flue holes and wire fixing kit.
- Using a long masonry drill, make two pilot holes completely through the wall, ensure the holes are drilled accurately at the centres and square to the wall both horizontally and vertically at the two cross points previously marked.
- Cut out the brickwork of the inner skin of the cavity wall for the lintel, and position and fix the lintel with mortar.
- Cut out the brickwork under the lintel, between the two outside vertical lines into the cavity. Ensure the cut-out width is square, try the appliance into the opening.
- Using 125mm (5") core drill, cut two holes following the pilot holes, drill from the outside through to the cavity.

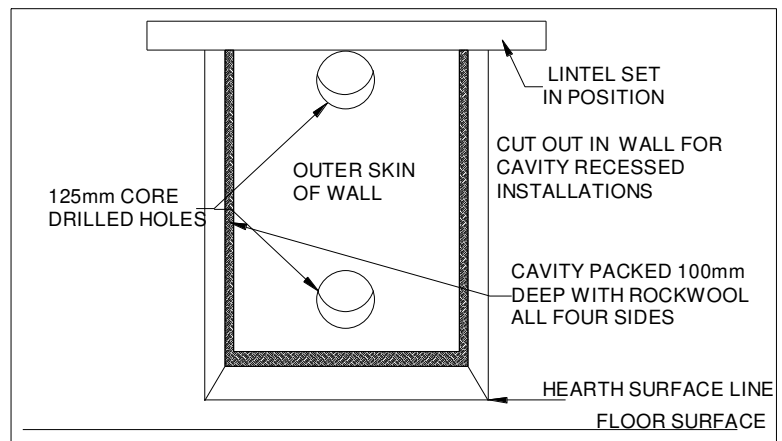

- Remove any cavity insulation from the cut-out opening and for a further 100mm into the cavity gap each side and above.
- Pack "Rockwool" around the sides and top of the opening into the cavity for a depth of 100mm.
- Lay the hearth if required so that it is positioned correctly to the horizontal line.
- Position and fix the back panel and surround if required.
- Offer the appliance into the opening and mark through the gas pipe entry hole (see connecting the gas supply later in this manual).
- Pass a tape measure through the core-drilled holes and record the distance from the back of the spigots to the surface of the outside wall.

- Increase both the recorded distances by 15mm each, and cut two lengths from the 100mm diameter pipe.
- Remove the appliance from the opening, and position the gas supply (see connecting the gas supply later in this manual), taking account of the relative gas regulations appertaining to a gas pipe in a cavity. Note the gas feed must be fitted with an isolation valve.
- Position and seal the pipes to their respective spigots on the rear of the appliance (use flue seal or fire cement to ensure airtight seal, it must not obstruct the flue).
- Peel the backing off the length of foam seal and affix to the rear outer edge of the appliance flange.
- Push the appliance back into the opening and fill any space behind the appliance with “Rockwool”.
- Complete the gas connection (see connecting the gas supply later in this manual).
- Drill the four fixing holes through the hole in the flange of the appliance and fix back using plug and screws.

### **Using the optional wire fixing kit:**

Follow all the above steps up to connecting the gas supply.

Undo the 2 central M6 screws from the bracket on rear of the firebox and slide the wire fixing clamp off.

Unravel the cable and push the nipple end onto the bracket. Replace the fixing clamp and screws and secure tightly. The cable is now attached to the firebox.

Push cable through the central pilot hole that has been drilled in the outside wall. Go outside and pull any excess cable through. Come back inside and push the firebox into the opening, ensuring the fire is level and the seal is evenly fitted to the back panel.

Go back outside and, again, pull any excess cable through the pilot hole. Slide the wall mounting plate over the cable using the centre hole. Align the cable fixing hole over the central pilot hole. Mark the hole centres, drill, and fasten back to the external wall using screws and raw plugs (not provided).

Adjust nut and slide down the cable over the wall mounting plate into the central pilot hole.

Slide the provided clamp over the cable, pull any excess then tighten using the screw on the clamp.

Using a 10mm spanner adjust the locking nut until tight.

Go back inside to ensure the seal on the fire is tight against the back panel and fire.

Go back outside and wrap any excess cable around the ledge on the bracket and through the feed hole.

### **Important: Do not cut off excess cable**

***Note: Please check the adjustment on the fixing is no more than 15mm as this may cause difficulty when fitting the outer terminal.***

- Fit the outer wall terminal plate, with the “Rockwool” gasket sandwiched between it and the wall, with the double spigot at the top so that it seals to both the flue pipe and the air duct, (use flue seal or fire cement to ensure air tight seal).
- Drill through the four holes in the outer wall terminal plate and fix back to the wall using plugs and screws.
- Position the outer terminal cover and fix to wall terminal plate with the four screws provided.
- If the flue outlet is fitted below 2m from the floor or a balcony then the flue guard must be fitted.

## **INSTALLING THE APPLIANCE INTO DEEP REBATED FIRE SURROUND OR DUMMY CHIMNEY**

### **BREST.**

**Additional duct pipe/s will be required.** (When installing in a timber framed dwelling reference must be made to the specific installation requirements stated later in this Section 'Installing The Appliance In Timber Framed Dwelling').

- Ensure it is a suitable outside wall constructed of non-combustible materials and that the flue position meets the requirements previously described.
- Mark a horizontal line on the wall at the intended hearth surface or appliance base height (150mm min. for Hole in Wall installation) the skirting board must be cut away from behind the fire.
- Mark a vertical line on the wall at the intended centre of the appliance up from the horizontal line for a height of 555mm.
- Mark two short horizontal lines so they cross the centre line, one at 105mm and the second at 480mm above hearth level line. These are the centre points for the air duct and flue holes.
- Using a long masonry drill, make two pilot holes completely through the wall, ensure the holes are drilled accurately at the centres and square to the wall both horizontally and vertically at the two cross points previously marked.

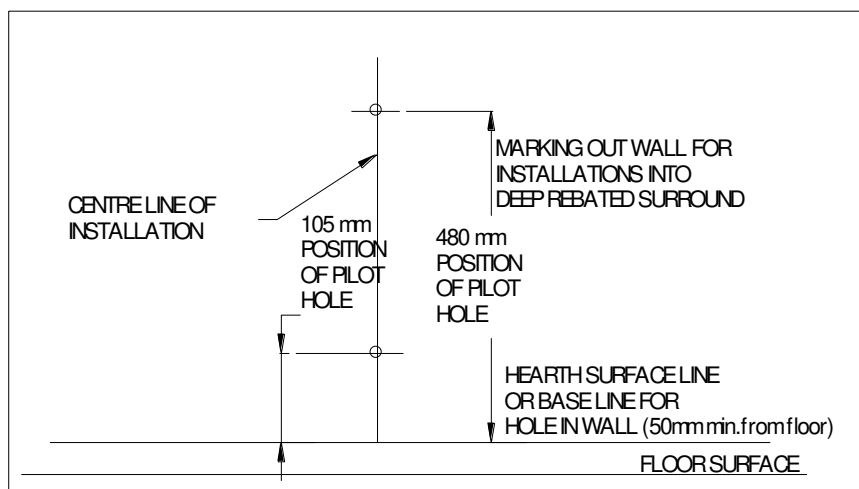

Using 125mm (5") core drill, cut two holes following the pilot holes, drill from the outside of the dwelling through to the cavity, and from the inside through to the cavity

- Remove any combustible material that may be present if the rear of the appliance is contacting the wall i.e. ensure no battens etc., behind dry lining
- Lay the hearth or a non-combustible base (for Hole in Wall) so that it is positioned correctly to the horizontal line.
- Temporally position and fix the back panel and deep surround, or construct a dummy chimney breast as required, avoiding combustible materials coming in close proximity to the appliance or the flue, leaving access to pack around the appliance with "Rockwool".
- Offer the appliance into the opening and mark through the gas pipe entry hole (see connecting the gas supply later in this manual).
- Pass a tape measure through the core-drilled holes and record the distance from the back of the spigots to the surface of the outside wall.
- Increase both the recorded distances by 15mm each, and cut the lengths from the 100mm-diameter pipe - you will probably require an extra pipe.
- Remove the appliance from the opening, and position the gas supply (see connecting the gas supply later in this manual), taking account of the relative gas regulations appertaining to a gas pipe in a cavity.
- Permanently fix the deep rebated surround in position, and pack the void behind the fascia panel of the deep rebated surround with "Rockwool". Pack 150mm thickness of "Rockwool" over the appliance top and side if it is fitted into a dummy chimneybreast, and fill any space between the appliance and the outside wall.
- Position and seal the pipes two their respective spigots on the rear of the appliance (use flue seal or fire cement to ensure airtight seal, it must not obstruct the flue).

- Peel the backing off the length of foam seal and affix to the rear outer edge of the appliance flange.
- Push the appliance back into the opening and fill any space behind the appliance with “Rockwool”.
- Complete the gas connection (see connecting the gas supply later in this manual).
- Drill the four fixing holes through the hole in the flange of the appliance and fix back using plus and screws.
- Fit the outer wall terminal plate, with the “Rockwool” gasket sandwiched between it and the wall, with the double spigot at the top so that it seals to both the flue pipe and the air duct, (use flue seal or fire cement to ensure air tight seal, it must not obstruct the flue).
- Drill through the four holes in the outer wall terminal plate and fix back to the wall using plugs and screws.
- Position the outer terminal cover and fix to wall terminal plate with the four screws provided.
- If the flue outlet is fitted below 2m from the floor or a balcony then the flue guard must be fitted.

### **TIMBER FRAMED DWELLING**

**This method allows for installation in timber frame buildings. Where removal of any part of the inner timber leaf of the wall is involved the structural integrity of the wall must be maintained and the advice of your local Building Control Department should be sought. If the property is under N.H.B.C. cover, it is advised that their advice should also be sought. Reference should be made to the British Gas Publication DM2 "Guide For Gas Installations In Timber Frame Housing" or Gas Safe "Gas installations in Timber Frame Buildings" ISBN1-902632-30-3**

Special attention must be paid to the location of the studwork frames of the inner leaf and the appliance positioned accordingly. Electrical cables and pipe work that run within the inner timber leaf must also be located and taken into account when positioning the appliance.

The following methods of installation may be adapted for use in timber frame buildings providing extra care is taken to protect combustible materials from contact with hot surfaces.

#### **Method 1 (For installation into a extended fire surround or false chimney breast)**

- An insulation material (20mm “Superlux” or equivalent) must protect all combustible surfaces (including plasterboard) situated within the opening. A minimum clearance of 50mm must be allowed between the appliance case (rear, top and sides) and the material used to line the opening. The base of the opening must be non-combustible.
- Wrap the appliance body (top, rear and sides) and both flue tubes with “Rockwool” (50mm minimum thickness).
- Where the duct pipes pass through the inner timber leaf concentric holes 200mm diameter should be cut around each duct pipe, allowing a minimum 50mm air gap all round each duct pipe. A non-combustible sleeve 200mm diameter must be fitted to these clearance holes.
- To ensure that any condensation formed on the duct pipes does not drip on to the inner wall a length of galvanised wire must be wrapped around each flue pipe and secured in position by twisting the ends together. Ensure that the twisted ends are located at the bottom of the pipes and the wire is centrally located within the cavity.
- The vapour barrier on the back of the inner timber leaf should be carefully cut and fixed to prevent ingress of damp into the plasterboard layer.



## **Method 2 (For installation into the inner timber leaf of the wall)**

- Find a suitable position between the wall panel frames and carefully open up a hole (minimum dimension 505mm wide x 605mm x 230mm depth) this will ensure 50mm minimum clearance around the appliance body Note: the 230mm could be reduced to 200mm if no combustible material is left between the back of the fire box and the outer skin on brickwork. Careful attention must be made to securing the damp proof membrane back into position. (Note: To achieve the minimum depth requirement it may be necessary to deepen the cavity by building up the wall surface with an appropriate non combustible material.)
- Line the exposed cavity (top, rear and sides) with an insulation material (20mm “Superlux” or equivalent) to form a boxed chamber. The base of the opening must be non-combustible.
- Wrap the appliance body (top, rear and sides) and both flue tubes with “Rockwool” (50mm minimum thickness).
- Where the duct pipes pass through the inner timber leaf, concentric holes 200mm diameter should be cut around each flue pipe, allowing a minimum 50mm air gap all round each flue pipe. A non-combustible sleeve 200mm diameter must be fitted to these clearance holes.
- To ensure that any condensation formed on the duct pipes does not drip on to the inner wall a length of galvanised wire must wrapped around each flue pipe and secured in position by twisting the ends together. Ensure that the twisted ends are located at the bottom of the pipes and the wire is centrally located within the cavity.
- The vapour barrier on the back of the inner timber leaf should be carefully cut and fixed to prevent ingress of damp into the plasterboard layer.

**NOTE:** Neither the appliance nor the “Rockwool” insulating pad may overhang the cavity space. Routing of the gas supply must be carried out inline with the recommendations specified in the British Gas Publication DM2 ‘Guide for gas installation in Timber Frame Housing.

## **CONNECTING THE GAS SUPPLY**

**TURN OFF ANY GAS APPLIANCES THAT ARE FED BY THE METER AND ISOLATE THE GAS SUPPLY BY TURNING OFF AT THE METER.**

- Connections may be made from the front of the appliance from either the left or the right in 8mm-dia. pipe or a concealed connection from the rear of the appliance a hole with a grommet is provided at the rear.
- An isolating cock is fitted in the supply feed to the fire to facilitate servicing. It may be rotated for right gas connection.
- When a concealed gas fitting from the rear is required it is necessary to route the pipe to the left side of the unit, taking into account the requirements of BS 6891 1988 dealing with enclosed pipes.
- When installing the firebox into a cavity wall, any part of the installation pipe work installed in the void open to the cavity wall must be enclosed in a gas tight sleeve. It must be sealed at the point at which the sleeved installation pipe enters the fire (The Gas Safety (Installation and Use) Regulations Certificate of exemption number 1 of 1996). Where the pipe enters the fire the outer sleeve must be sealed to the grommet and the pipe must be sealed to its outer sleeve using suitable mastic.

## **CHECKING GAS SOUNDNESS**

- Complete gas connection to the fire and check for gas soundness in accordance with current codes of practice.

## **INJECTOR REMOVAL**

This appliance is fitted with the 5.4 kw high input injector with the option of fitting the supplied reduced 3.8 kw input injector. To change the injector firstly remove the burner bar. Remove the two screws at either side of the burner and lift out from the right hand side first.

The injector nipple can be changed with a spanner, change the injector `TIP` only.

Refit the other Injector and retighten with a

spanner. **NOTE:** The other Injector needs to be left with the appliance or the customer.

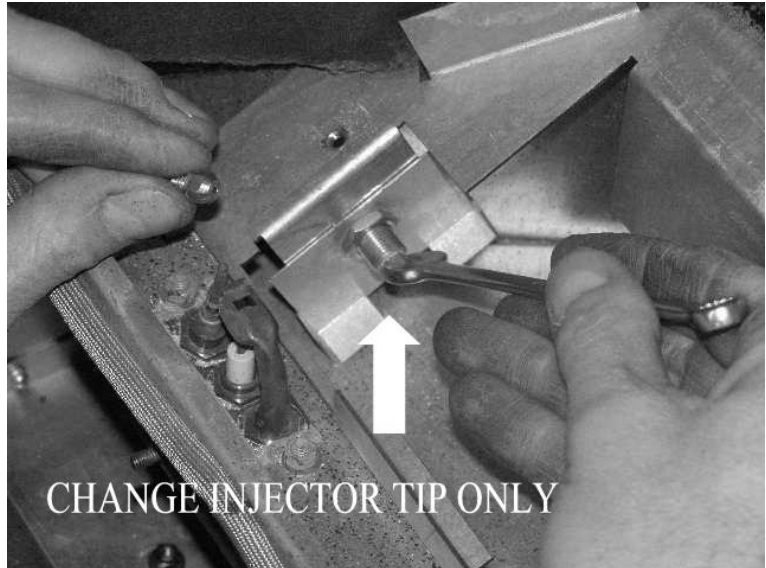

Refit the burner bar by sliding the left hand side first, make sure not to damage the injector tip when replacing burner bar.

Retighten the two screws and ensure the burner bar is central and flat to the burner carrier.

## **SECTION ELEVEN Assemble the Appliance (installation instructions)**

- Position the refractory fuel bed components as described in section four of this manual, it is important that the fuel bed is positioned exactly as described to ensure the correct operation of the appliance. Badly positioned fuel bed components may result in the gas flame being driven forward onto the glass and permanently marking it.
- Slide the top of the Glass Frame under the Glass Frame Bracket on the fire and centralize the slots over the Four fixing studs, making sure the seal inside the glass.
- Ensure it is positioned centrally with the printed surface to the inside and the open slots at the lower edge.
- Start the nuts on these four studs.
- Tighten the Four nuts up evenly ensuring that the glass compresses the seal on all four sides.
- Position the fret apron and secure with two cross head nuts.
- Position the grill fascia so that it hooks centrally over the top flange of the combustion box and covers the front edge of the glass frame.
- Position four magnets in two up each side of the appliance flange, and offer the decorative trim up squarely and centrally.

## SECTION TWELVE Check Operation of Fire (installation instructions)

### CHECK BURNER PRESSURE AND GENERAL OPERATION

- Remove the screw from the pressure test point on the burner inlet elbow and fit a pressure test gauge.
- Turn on the gas to the appliance. Purge the air from the appliance by rotating the control to the ignition position, push in to allow the air in the pipe work to be purged and the piezo to ignite the pilot.
- Check that the electrode is sparking at the gap between the thermocouple tip and the electrode, continue until pilot ignition is established.
- Depress the control knob slightly and rotate anti-clockwise until the index symbol is aligned with the  on the indicator label, release and allow the appliance to run for a period of approximately 5 minutes.
- Check that the inlet pressure 20mbar +/- 1 mbar for natural gas.
- Turn off the gas control and remove pressure test gauge.
- Refit the screw into the pressure test point and turn on the appliance again, check that the screw has sealed with leak detection fluid.
- Turn the appliance off.
- Position a suitable fire fret up to the appliance conforming to the requirements referred to in section one of this manual.

## SECTION THIRTEEN Instruct and Advise the Customer (installation instructions)

- Demonstrate the lighting and extinguishing procedure to the consumer/user and the removal and refitting of the decorative trim for cleaning.
- Explain that for the first few hours of the fire operating there will be an initial odour. This is due to the curing of the paint, the appliance should be operated on its high setting, and it is recommended that a window is left open until that odour has completely disappeared.
- Instruct on the glass removal and refitting.
- Instruct on the fuel bed cleaning and advise that a vacuum cleaner can be used but only after all the loose fuel bed shapes have been removed. **Refer to 'Health & Safety Notice (See Section One) at the front of this booklet before proceeding.**
- Advise that the appliance should be serviced annually by a competent person i.e. a **Gas Safe registered engineer** in accordance with these instructions.
- Although the appliance is fitted with a glass front which acts as a dress guard it is strongly recommended that a fireguard should be used for the protection of children, the elderly or infirm. Fireguards should conform to B. S. 6539 (1984) (Fireguards for use with solid fuel appliance).
- **Hand these instructions to the user.**

## SECTION FOURTEEN Maintenance Instructions (maintenance instructions)

### General

- Servicing should be carried out annually by a competent person such as a Gas Safe-registered person in accordance with the relevant regulations, to ensure the safe and correct operation of the appliance.

**Warning: - Before commencing any service or replacement of parts, turn off the gas supply to the fire.**

- After servicing check for gas soundness.
- When ordering spare parts please quote appliance name and serial number these can be found on the data badge, which is located on the appliance remove the decorative fire front for access.
- If soot has accumulated check to establish cause, rectify and clean flue accordingly.

**Important: - Refer to 'Health & Safety Notice (See Page 3) at the front of this booklet before removing the fuel bed components.**

- Examine the coals for signs of cracking and replace if necessary.(IMPORTANT) see coal layout procedure in section four of this manual before attempting to replace coals, which should only be replaced as a complete set with no extra coals added.
- Check pilot aeration holes for linting, use a vacuum cleaner to remove any lint taking care not to damage the pilot head.

### Replacement of Gas Control

1. Remove the fret or fascia and turn off the gas supply by the isolation cock.
2. Remove the gas control knob
3. Remove the control plate held by 2 screws on the left hand side.
4. Disconnect the injector pipe from the left hand side of the gas control.
5. Disconnect the pilot pipe from the underside of the pilot burner.
6. Pull off the connection to the spark electrode
7. Undo the supply connection to the pressure test elbow.
8. Remove the 2 connections to the micro switch.
9. Remove the two screws holding the gas valve bracket to the casing.
10. Pull the complete assembly forward and remove the thermocouple from the rear of the gas control.
11. Carefully remove the cam from the spindle of the gas control ensuring you note its correct orientation on the spindle for later reassembly.
12. Disconnect remaining pipes and bracket from the control.
13. Change or service the valve and replace in reverse order.
14. Turn on the gas supply, check for soundness and recommission.

### Replacement of Injector

1. Remove the fret or fascia and turn off the gas supply by the isolation cock.
2. Remove the glass and fuel bed components as described earlier in this manual.
3. Undo and remove the 2 screw holding the burner in place
4. Carefully remove the burner lifting from the right hand end of the burner.
5. Loosen and remove the injector tip.
6. Clean or replace injector tip and replace in reverse order, ensuring that the connection to the injector fixing is sound air test if in doubt.
7. Turn on the gas supply, check for soundness and recommission.

### **Replacement of the Micro Switch**

1. Repeat operations 1-3 for removal of gas control.
2. Pull off the cable connections from the switch.
3. Remove the two screws holding the switch in place and lift away the switch, replace in reverse order.
4. Turn on the gas supply, check for operation of switch.

### **Replacement of the Thermocouple**

1. Repeat operations 1-13 for removal of gas control.
2. Pull off the cable connections from the switch.
3. Replace in reverse order.
4. Turn on the gas supply, check for soundness and recommission.

### **Replacement of the Pilot Injector**

1. Undo the pilot tube nut at the pilot bracket.
2. Pull the pipe gently back taking care not to damage.
3. Remove the pilot injector from inside the pilot bracket.
4. Clean or replace in reverse order, turn on the gas supply, check for soundness and recommission.

### **Replacement of the Spark Electrode**

1. Remove the cable from the electrode connection.
2. Undo the electrode nut at the pilot bracket.
3. Remove the electrode carefully.
4. Clean or replace in reverse order, and recommission.









## Register your appliance online today to active your warranty



## BALANCED FLUE GAS FIRE COMMISSIONING CHECKLIST

**This Commissioning Checklist is to be completed in full by the competent person who commissioned the gas fire as a means of demonstrating compliance with the appropriate Building Regulations and then handed to the customer to keep for future reference.**

Failure to install and commission according to the manufacturer's instructions and complete this Benchmark Commissioning Checklist will invalidate the warranty. This does not affect the customer's statutory rights. **PLEASE COMPLETE IN BLOCK CAPITALS.**

Customer name:	Telephone number:
Address:	
Gas Fire make and model:	
Installation location: i.e living/dining room.	
Gas Fire serial number:	
Commissioned by (PRINT NAME):	Gas Safe register number:
Company name:	Telephone number:
Company address:	
	Commissioning date:
Building Regulations Notification Number (if applicable):	

Site Requirements	Yes	N/A
Is the flue terminal sited and fitted as per the manufacturer's instructions?		
Has a flue guard been fitted?		
<b>Hearth Requirements- where fitted</b>		
Is the hearth constructed from non -combustible material?		
Is the hearth a minimum of 12mm thick with a minimum floor to top surface of 50mm?(BS5871) or as per manufacturer's instructions?		
Is the hearth for open fronted fires a minimum of 760mm wide and has 300mm projecting from the fire opening (BS6871) or to manufacturer's instructions?		
Mounting height (where applicable) has the fire been installed to the correct mounting height- as per manufacturer's instructions?		
<b>Firebox and Fuel Bed</b>		
Has the fuel bed, coals, logs, pebbles etc. been fitted to manufacturer's instructions?		
<b>Gas Supply</b>		
Has an isolation valve inlet elbow been fitted for servicing?		
Has the gas supply been thoroughly purged prior to connection to remove any debris?		
Has a gas tightness test been completed prior to breaking into the gas supply and following completion of installation?(IGEM/UP/1B)		
Has the correct gas type been chosen as per manufacturer's instructions?		
Record burner gas pressure reading? If only the supply pressure is available a gas rate must be undertaken.(GSIUR REG26/9C)		
Record dynamic inlet gas pressure (working pressure) reading (all gas appliances running)		
<b>Installation</b>		
Has the gas fire/convector heater been installed and commissioned in accordance with manufacturer's instructions?		
Has the gas fire/convector heater been installed with the correct clearance to combustible materials, service and general clearances adhered to as per manufacturer's instructions?		
The operation of the fire/convector heater and controls have been demonstrated and understood by the customer, including replacement of batteries?		
The manufacturer's literature, including Benchmark Checklist and Service record has been explained and left with the customer?		
Has the appliance been registered with the Local Authority, as detailed on the Gas Safe web site and is a legal requirement and forms part of the warranty?		
Commissioning Engineer's Signature		
Customer's Signature (To confirm satisfactory demonstration and receipt of manufacturer's literature)		

\*All installations in England and Wales must be notified to be Local Authority Building Control (LABC) either directly or through a Competent Persons Scheme. A Building Regulations Compliance Certificate will then be issued to the customer

# SERVICE RECORD

**It is essential that your gas fire is serviced regularly and that the appropriate Service Interval Record is completed. Service Provider**

Before completing the appropriate Service Record below, please ensure you have carried out the service as described in the manufacturer's instructions. Always use the manufacturer's specified spare part when replacing controls.





















<b>SERVICE 01</b>	Date:
Engineer name:	
Company name:	
Telephone No:	
Gas safe register No:	
Comments:	
Signature	

<b>SERVICE 02</b>	Date:
Engineer name:	
Company name:	
Telephone No:	
Gas safe register No:	
Comments:	
Signature	

<b>SERVICE 03</b>	Date:
Engineer name:	
Company name:	
Telephone No:	
Gas safe register No:	
Comments:	
Signature	

<b>SERVICE 04</b>	Date:
Engineer name:	
Company name:	
Telephone No:	
Gas safe register No:	
Comments:	
Signature	

<b>SERVICE 05</b>	Date:
Engineer name:	
Company name:	
Telephone No:	
Gas safe register No:	
Comments:	
Signature	

Product ID Label	A-0283	Serial No Prefix	MD		
Fixing Kit (0474) / eye bolt		screw	magnet	wall plug	
					
	Qty 4	Qty 4	Qty 4	Qty 4	
Data Badge					
Burner Tray / Box Assembly					
Air Test Completed					
Microswitch Check					
High Rate Injector Tip 1 x 360 (5867)					
Low Rate Injector Tip 1 x 220 (5868)					
Installation Seal (4904)					
Copper Washer		/	Wall clamp (Part No 5869)		
Restrictor Elbow (2189)					
Magnets (4 x 3048)					
Glass Assembly / Warning Label (Fire Guard)					
					
Canopy (4540)		Nut Spinner (5435)			
					
Flue Assembly	S/S screw (Qty 4)	Small Sealable Bag			
Terminal Guard					
					
Wall Gasket	Terminal Guard				
Flue Pipe x 1	Fret Plate x 1				
					
Owners Book					
Serial Number					
Inspector					