

The **fireplace**  
*and*  
**electric fire**  
*collections*



**Charlton & Jenrick**<sup>LTD</sup>

*Best of British fires, fireplaces & stoves* Issue 1



*Welcome to the new Charlton & Jenrick range of contemporary and traditional fireplaces. As a leading UK manufacturer and supplier we take great pride in the design and manufacture of our fireplaces, fires and wood burning stoves. The end result is a stunning range of fireplaces that work, as designed, in harmony with a wide choice of fires and multi-fuel stoves.*

*All the fireplaces in this brochure are designed and manufactured with quality in mind using the best available Limestone, American White Oak & Black Walnut. On each page you will find swatches of the available finishes to the fireplace so you can see the full range on offer. However, we believe to fully understand these designs and finishes you need to see the products in the flesh. We always recommend that you visit a Charlton & Jenrick authorised showroom to see the fireplaces in their true glory.*

 **Katell** *fireline*<sup>TM</sup>



## Limestone Range

Aylesbury	4
Balmoral	5
Beckford	6
Boscombe	7
Burcombe	8
Camellia	9
Cotswold Arch	10
Faro	11
Katia	12
Leighton	13
Mafra	14
Oslo	15
Radnor	16
Rembrant	17
Seville	18
Stokesay	19
Stonehenge	20
Wave	21



## Timber Surrounds – City Collection

Auckland	30
Berlin	31
Henfield	32
Wylam	33

## Electric Suites

Galaxy	34
Jupiter	35
Orchid	36
Telstar	37

## Casts

Cast Range	38
Cast Options	39

## 16" Electric Fires

Ecoflame	40
Sensations	42

## Hang on the wall Electric Fires

Ecoflame (Glass fronted)	44
Equinox	45
Medi & Amara	46
Specifications	48
Dimensions	50



## Solid Timber Surrounds

Alderley	22
Ellington	23
Hyacinth	24
Jasmine	25
Rothbury	26
Sherburn	27
Waterford	28
Wentworth	29



## Limestone Range



### Aylesbury

An elegant and modern design shown above in Portuguese Limestone, featuring a Paragon Slimline 3 gas fire with brass Elite trim and coal fuel bed.



Above: In Portuguese Limestone with a chamber, featuring a Fireline FXW gas stove.



Above: In Portuguese Limestone, featuring a Paragon Focus HE gas fire with a brass Cast Fascia.

Finishes available:

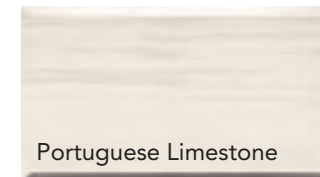

Portuguese Limestone



Above: In Portuguese Limestone with a chamber, featuring a Fireline FP5 Stove.



Above: In Portuguese Limestone with Black Granite back panel and hearth, featuring a Fireline FGi5W Inset Stove.

Finishes available:

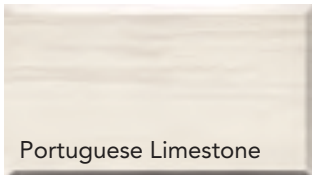

Portuguese Limestone



## Limestone Range

### Balmoral

A classic design, distinctive and graceful shown above in Portuguese Limestone with LED Illumination Kit, featuring a Paragon Focus HE Slimline gas fire in chrome trim and Gate fret.

## Limestone Range



### Beckford

The Beckford with shelf shown above in Portuguese Limestone, featuring a Paragon One Gas Fire with black Cast Fascia.



Above: In Portuguese Limestone featuring a Paragon 2000 Low Lintel gas fire in chrome trim and chrome Antique Bridge fret with coal fuel bed.



Above: In Portuguese Limestone with Black Granite Back Panel and Hearth, featuring a Fireline FPI5 Inset Stove.

Finishes available:

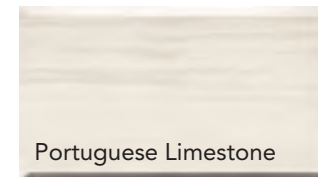

Portuguese Limestone



Above: In Portuguese Limestone with a Black Granite chamber, featuring a Fireline FX8 Stove.



Above: In Portuguese Limestone with a chamber, featuring a Fireline FX8 Stove.

Finishes available:

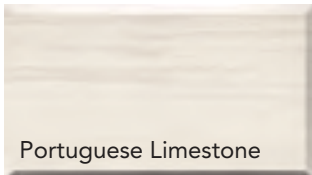

Portuguese Limestone



Limestone Range

## Boscombe

A beautifully crafted fireplace shown above in Portuguese Limestone, featuring a Paragon Focus HE gas fire with brass Cast Fascia.

## Limestone Range



### Burcombe

An elegant fireplace shown above in Portuguese Limestone, featuring a Paragon 2000 Plus gas fire with brass Cast Fascia.

Finishes available:

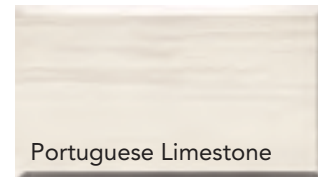

Portuguese Limestone





Finishes available:

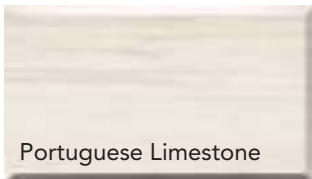

Portuguese Limestone

## Camellia

The Camellia is an elegant modern surround shown here in Portuguese Limestone featuring a coal Eco Flame electric fire with Chrome Twintone trim and Gate fret

## Limestone Range



### Cotswold Arch

A beautifully carved fireplace shown above in Portuguese Limestone, featuring a Paragon One gas fire with brass Cast Fascia.



Above: In Portuguese Limestone with a Black Granite chamber, featuring a Fireline FX5 Stove.



Above: In Portuguese Limestone with a chamber, featuring a Fireline FX5 Stove.

Finishes available:

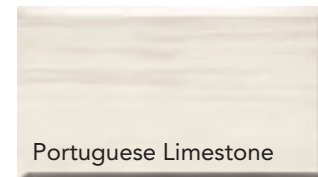

Portuguese Limestone



Above: In Portuguese Limestone, featuring a Paragon 2000 Plus gas fire with black Cast Fascia.



## Limestone Range

Finishes available:



Portuguese Limestone

## Faro

An elegant combination of curves that brings out the beauty of natural stone shown above in Portuguese Limestone, featuring a Paragon Focus HE Slimline gas fire in chrome Elite Trim Fascia.

## Limestone Range



### Katia

An elegant compact fireplace shown above in Portuguese Limestone, featuring a Matchless Heat Machine DVX gas fire with brass Twintone trim and Buttress fret.



Above: In Portuguese Limestone with Black Granite back panel and hearth, featuring a Fireline FPI5 Inset Stove.

Finishes available:

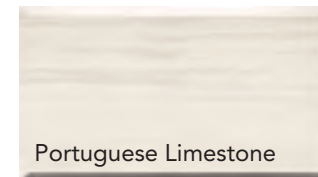

Portuguese Limestone

## Limestone Range



Finishes available:



Portuguese Limestone

## Leighton

A contemporary fireplace with crisp clean lines shown above in Portuguese Limestone, featuring the Eco Flame 16" electric fire with Elite Satin Fascia.

## Limestone Range



### Mafra

An elegant fireplace shown above in Portuguese Limestone, featuring a Paragon Focus HE gas fire in the Chirbury Performance Combo cast.

Finishes available:

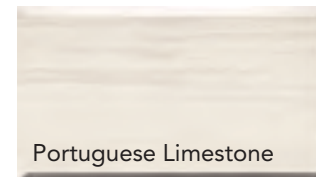

Portuguese Limestone



Above: In Portuguese Limestone, featuring a Paragon 2000 Plus gas fire with a chrome trim and Gate fret.



## Limestone Range

Finishes available:

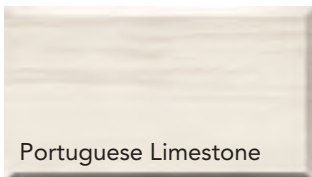

Portuguese Limestone

## Oslo

A stunningly simple design shown above in Portuguese Limestone, featuring a Matchless Heat Machine DVX gas fire in the Twintone chrome trim and Bayswater fret.

## Limestone Range



### Radnor

A striking fireplace shown above in Portuguese Limestone, featuring a Paragon Focus HE 18" gas fire with brass Antiqued Bridge fret.

Finishes available:

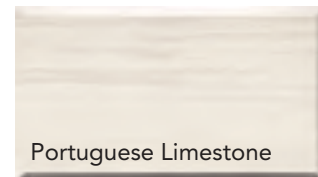

Portuguese Limestone



## Limestone Range



Finishes available:

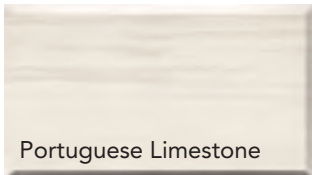

Portuguese Limestone

## Rembrandt

A regency style complete fireplace featuring a Paragon One Convactor with chrome Cast Fascia.

## Limestone Range



### Seville

A contemporary fireplace shown above in Portuguese Limestone, featuring a Matchless Heat Machine DVX gas fire with brushed steel Seville fascia.

Finishes available:

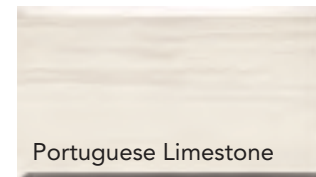

Portuguese Limestone



Above: In Portuguese Limestone, featuring the FX5W free-standing stove.

Finishes available:

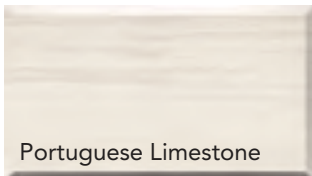

Portuguese Limestone

## Limestone Range



## Stokesay

A striking fireplace shown above in Portuguese Limestone, featuring a Paragon Focus HE 18" gas fire with chrome trim and Antique Bridge fret.

## Limestone Range



### Stonehenge

A contemporary fireplace shown above in Portuguese Limestone, featuring a Paragon Focus RS Plus balanced flue gas fire with chrome Cast Fascia.

Finishes available:

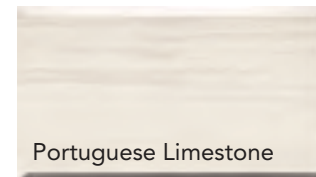

Portuguese Limestone

## Limestone Range



Finishes available:

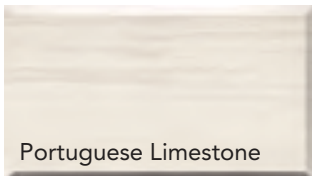

Portuguese Limestone

## Wave

An imposing sculptured Portuguese Limestone surround, featuring the Paragon Convector P1 gas fire with satin chrome Elite fascia.

## Solid Timber Surrounds



### Alderley

Shown in Natural Oak with black granite back panel and hearth, featuring the Regent LED 2kW electric fire in a brushed steel finish.

Finishes available:



Chestnut



Natural Oak

## Solid Timber Surrounds



Finishes available:



Natural Oak



Golden Oak

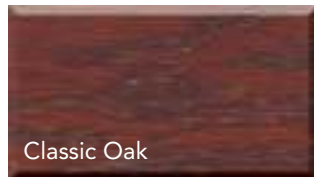

Classic Oak

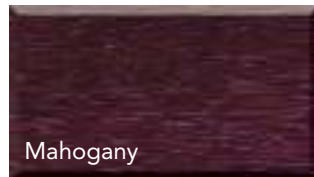

Mahogany

## Ellington

Shown in Natural Oak finish  
featuring Westbourne LED electric fire in Brass & Black finish.

## Solid Timber Surrounds



### Hyacinth

Shown in natural Oak finish featuring Malvern Polished Chrome 1.2KW electric fire, coals and pebbles provided. Also available without shelf.

Finishes available:



Chestnut



Natural Oak



## Solid Timber Surrounds



Finishes available:



Natural Oak

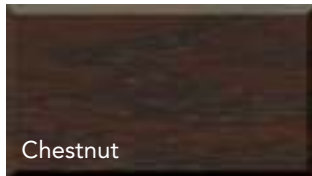

Chestnut

## Jasmine

Shown in Natural Oak finish, featuring Rosemoor Polished Chrome 1.2kW heat output electric fire, coals and pebbles provided.

## Solid Timber Surrounds



### Rothbury

Shown in Natural Oak finish featuring Savoy 2kW heat output, manual controlled, LED electric fire in Black & Brushed Steel finish. Also available with downlights.

Finishes available:

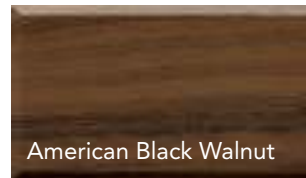

## Solid Timber Surrounds



Finishes available:



Natural Oak



Golden Oak

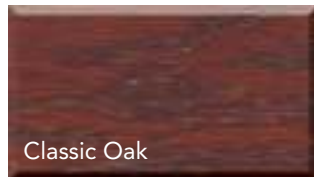

Classic Oak

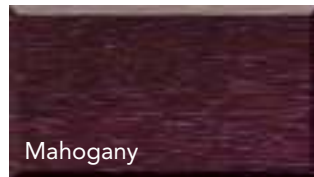

Mahogany

## Sherburn

Shown in Natural Oak finish  
featuring Savoy LED electric fire in Brass & Black finish.

# Solid Timber Surrounds



## Waterford

Shown in Natural Oak finish, featuring Savoy LED electric fire in Brass & Brushed Brass finish

Finishes available:



## Solid Timber Surrounds



Finishes available:



Natural Oak



Golden Oak



Classic Oak

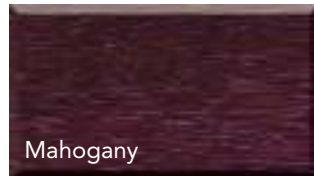

Mahogany

## Wentworth

Shown in Natural Oak finish  
featuring Savoy LED electric fire in Brass finish.

# City Collection



## Auckland

Shown in Natural Oak with black granite back panel & hearth, featuring the Regent LED 2kW electric fire in a brushed steel finish.

Finishes available:



Chestnut



Natural Oak



Finishes available:



Natural Oak

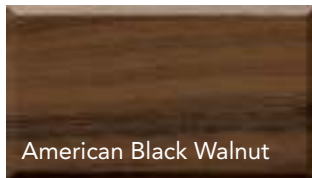

American Black Walnut

## Berlin

Shown in American Black Walnut with black granite back panel & hearth and down lights, featuring the Westminster Enviraflame LED 1.5kW electric fire electric fire in a brushed steel finish.



## Henfield

Shown in Natural Oak,  
featuring the Redbridge LED 2kW electric fire in a brass finish.

Finishes available:



Chestnut



Natural Oak





Finishes available:

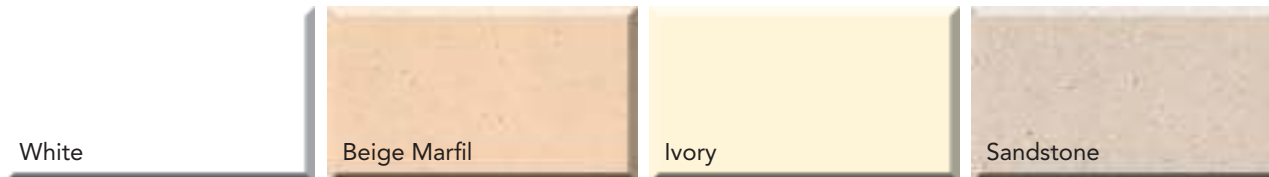

## Wylam

Shown in White finish with black granite back panel & hearth, featuring the Regent LED 2kW electric fire in a brass finish.

## Electric Suites



### Galaxy

Shown in White/Black finish – this contemporary designed suite is ideal for living areas without a chimney or gas supply, 2KW heat output, thermostatic control and an ultra low energy independent LED flame effect featuring a decorative tray effect fire with pebbles.

Finishes available:



Finishes available:



Sandstone

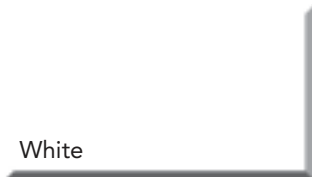

White

Shown in Sandstone/Brushed Steel finish, this modern electric suite is ideal for living areas without a chimney or gas supply, 2KW heat output, thermostatic control and ultra low energy independent flame effect featuring a decorative bowl with pebbles.

## Jupiter

# Electric Suites



## Orchid

Shown in Antiqued Ivory finish with Black Granite effect back panel and hearth, this traditional timber electric suite features a Malvern electric fire in polished chrome finish, with 1.2KW heat output, remote control, pebbles and coals provided

Finishes available:

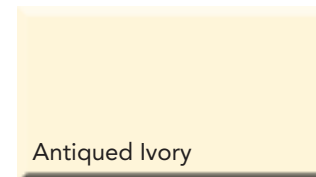

Antiqued Ivory



Finishes available:

White

Shown in White finish, this contemporary designed suite is ideal for living areas without a chimney or gas supply, 2KW heat output, thermostatic control and an ultra low energy independent LED flame effect, also featuring a decorative bowl with pebbles.

### Telstar

## Casts



## Chirbury Performance Cast Combination

The Performance Combo cast is designed to take all open and glass fronted gas fires from Charlton & Jenrick and is a patented system that allows quick and easy access to your fire for servicing. It gives the look of a traditional cast but the benefits of a highly efficient gas fire.



## Back Panel Options



## Casts

### Cast your imagination open to the possibilities!

The Chirbury high performance cast range is now available with a large number of options.

To order the cast you require simply follow the 3 steps below:

- Step 1:** Choose the Back Panel you require (either Burnished or Highlighted) Arch
- Step 2:** Choose from one of the four canopy options
- Step 3:** Choose one of the three options of frets.

## Canopy Options



## Fret Options



## 16" Electric Fires



### The Ecoflame™

Setting a new standard in low energy electric fires. A realistic flame effect, creating the perfect ambience for any room. Shown above is the Eco Flame 16" electric fire with Elite Satin Fascia in the Fireline Leighton surround.



# 16" Electric Fires



Building on the success of our popular Electron fire, the new Paragon Ecoflame gives an even more realistic flame effect and offers a choice of trims and frets.

- Ultra low-energy LED lighting flame effect uses only 4W
- Live powered animated flame effect lighting on fireback, inside firebox and under fuel bed
- Choice of trims and frets in brass, black and chrome
- Choice of coal or pebble fuel effect included
- 1kW & 2kW fan heating with independent flame effect setting
- Thermostat control for energy saving and comfort
- Full remote control
- 16" x 22" inset fire, Fits 3" (75mm) rebate
- Sets a new standard in design and aesthetics

All Charlton & Jenrick Ltd electric fires feature full remote control (handset designs vary according to fire model)



Above: Shown in brass Gate fret and brass Contrast trim.



Above: Shown in black Gate fret and brass Contrast trim.



Above: Shown in chrome Gate fret and chrome Contrast trim.

**Ecoflame™ flame effect uses 95% less energy than a conventional fire and 75% less than a low energy electric fire**

## 16" Electric Fires



### The Sensations with 3D Enviraflame™ technology

3D Enviraflame™ technology means that this realistic flame effect uses only 10% of the power of a conventional electric fire. Shown above in brushed stainless steel trim and Arc fret with the Fireline Faro surround.

# 16" Electric Fires

Here's a stunning effect with a lower carbon footprint; now you need never change a light bulb again.

With the Enviraflame system there are no light bulbs to fail, just ultra low-energy emitters – saving not only money, but the energy needed to make and transport the bulbs, to say nothing of the landfill from spent bulbs.



Above: Shown with Brass trim and Antique Wellington fret.



Above: Shown in Chrome trim and chrome Gate fret.

- Stunning 3D floating flame effect
- Low-energy 7W flame effect
- Flame effect still looks great wherever you are seated in the room
- No need for a glass panel between you and the 'flame'
- Enviraflame technology means that the flame effect only uses 10% of the power of a conventional electric fire! Kind on your pocket and the environment
- Remote control as standard
- Thermostatic fan heater with two settings – 750W and 1500W
- 3 fuel bed effect settings, adjustable to suit your mood
- Choice of trims and frets in brass, black and chrome
- Advanced slimline design means that the fire can be installed in any recess mantel with a 3" (75mm) rebate
- Complete with surface mounting spacer – for use on a flat wall without a mantel

See the fire working at [www.enviraflame.co.uk](http://www.enviraflame.co.uk)

All Charlton & Jenrick Ltd electric fires feature full remote control (handset designs vary according to fire model)



## Hang on the wall Electric Fires



### The Ecoflame™ wall-mounted

An ultra-sleek, modern, wall mounted, electric fire with the choice of a curved or flat glass front. The Ecoflame's realistic flame effect creates the perfect ambience for any room. Shown above with the curved glass front and log fuel bed.

Fuel beds available:





Above: Ecoflame shown with flat glass front and pebble fuel bed.

Enjoy the comfort and luxury of the new Ecoflame™ – simply plug in, switch on and warm up. The wall-mounted electric fire from Charlton and Jenrick is an ultra-modern fire packed with features and benefits.

This sleek, modern, 2kW wall-mounted electric fire is ideal for the more discerning customer. During its development, great attention has been paid to its quality and its specification. The Ecoflame™ is launched with a choice of flat or curved black glass, a fixed log or pebble fuel bed or the option to have no fuel bed at all, for an ultra-modern look. The Ecoflame™ is also very flexible and with heaters that blow from the side, it can be sited below a TV and even close to the carpet.

- Each fire comes with a choice of fuel bed – log or pebble
- 2 x 1kW independently selectable heaters that blow from the sides so it can be fitted below a TV and close to the carpet
- Variable brightness and colour flame effects
- LED back lighting (orange, white, blue or lightshow)
- Universal engine that accepts flat or curved fascias
- Superb bright flame effect that fills the large fire window
- Kettle plug for easy installation and servicing
- Full-feature remote control
- Separate wall-mounting bracket system for easy installation

## Hang on the wall Electric Fires



### Equinox

Shown in Black/Mirror Finish, with choice of fuel beds (logs and pebbles supplied), LED illuminated flame effect, 1KW and 2KW heat settings with thermostat control, variable brightness and colour flame effects (LED backlights in orange, white, blue and lightshow). Side blowing heaters allow fire fitting below TVs or close to the carpet, remote control supplied.

## Hang on the wall Electric Fires



### The Medi & Amara

Contemporary and stylish with unique features, designed to add a subtle ambience to your living room. Shown above is The Medi with flat glass front. All backlights are also available with the Medi fire. Unique features include subtle ambient backlighting and adjustable flame speed, to add an extra dimension of warmth. However, it's not just the contemporary looks that makes these fires stand out. Our dual heater fans are designed not only to warm your room, but to actually blow down, so the fire can be placed below a wall-mounted plasma TV.



Amara curved front with orange backlight



Amara curved front with blue backlight

- Ultra low-energy LED flame effect 7W-12W consumption
- 4 flame settings:
  - Bright orange flame with blue flicker
  - Bright orange flame
  - Medium orange flame and low orange flame
- 3 flame speeds – Slow/Medium/Fast
- 5 backlight settings – Off/Orange/Blue/Mixed colour/ Light show (cycles through the colours)
- Heater settings:
  - Off, right-hand side fan offering 0.75kW
  - Left-hand side fan offering 0.75kW
  - Both fans on offering 1.5kW
- Comes complete with a mixed box of opaque glass stones and natural cararra stones.
- Full remote control & manual back up switches on fire
- 1.5m white power cable, right-hand side entry
- 240v 13 amp input
- Complete with simple fixing kit including a full size wall template for ease of installation.

Flame settings:



Low orange flame



Medium orange flame

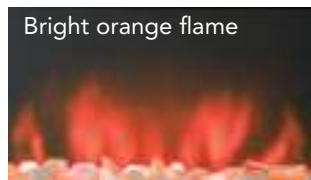

Bright orange flame



Bright orange flame with blue flicker effect



# Hang on the wall Electric Fires

All Charlton & Jenrick Ltd electric fires feature full remote control (handset designs vary according to fire model)

Shown above is the Amara curved front

Ideal for use under a plasma TV

# Specifications

## Chirbury Cast

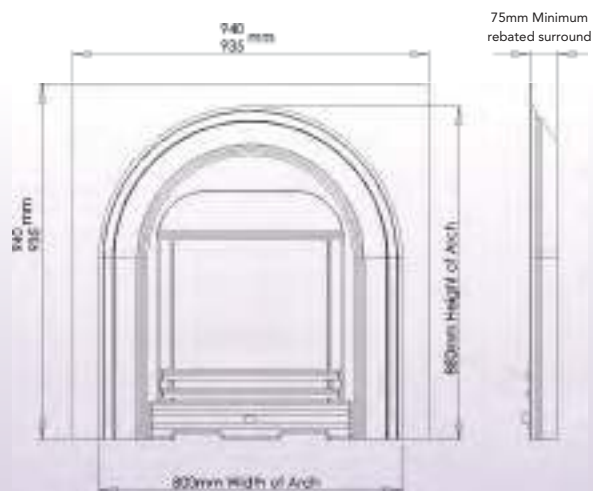

Page 38

## Ecoflame™

Low energy

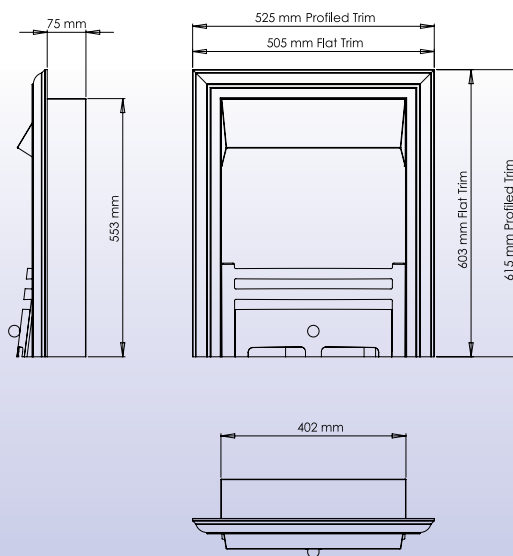

Page 40

## Sensations

3D Enviraflame™ technology

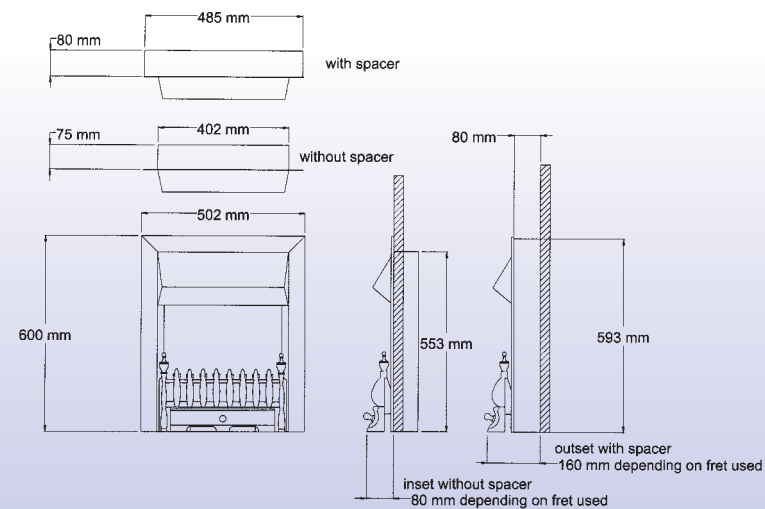

Page 42



## Ecoflame™

Wall mounted

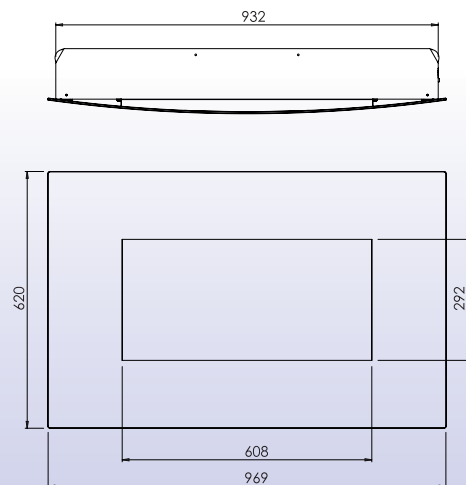

Page 44

## Medi & Amara

Glass fronted with ambient light

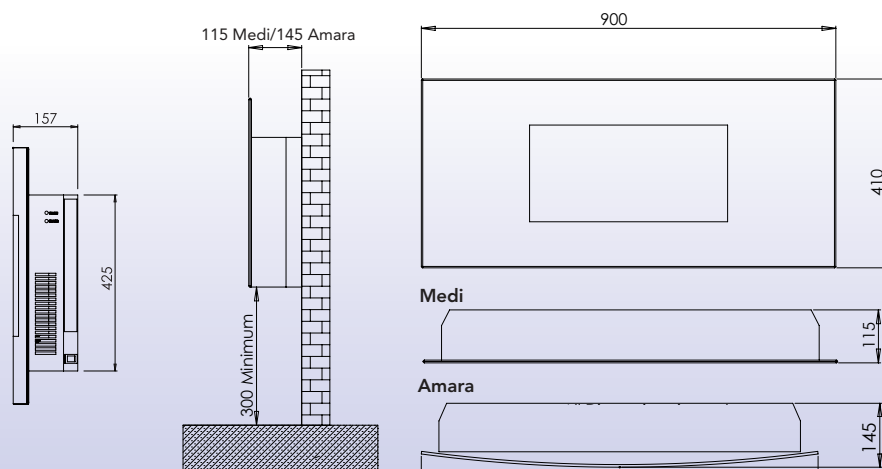

Page 46



All Charlton and Jenrick Ltd fires are manufactured under a BS EN ISO 9001 quality system (registration number 5195), which covers all areas of product design, development, manufacture and service.

These appliances conform with the requirements of the amended EEC directive no 89/336/EEC relating to electromagnetic compatibility (EMC) and are independently tested and certified to conform with relevant parts of EN60335.

# Dimensions

ALL MEASUREMENTS ARE MM

Model	Page	Shelf	Overall Height	Opening Width	Opening Height	Base Width	Hearth	Rebate
Aylesbury	4	1370 x 220	1160	810	837	1205	1370 x 470	80
Balmoral	5	1320 x 220	1110	900	830	1220	1320 x 380	35/76
Beckford	6	1120 x 150	1060	625	677	1114	1220 x 410	40
Boscombe	7	1320 x 180	1120	740	790	1200	1320 x 400	35
Burcombe	8	1220 x 170	1060	760	820	1120	1220 x 410	35
Camellia	9	1284 x 176	1120	798	805	1248	1320 x 383	80
Cotswold Arch	10	1345 x 180	1060	745	740	1210	1345 x 380	50/76
Faro	11	1340 x 210	1090	710	725	1230	1350 x 380	40
Katia	12	1120 x 200	985	629	676	995	1120 x 380	76
Leighton	13	1220 x 200	1085	745	775	1146	1220 x 350	70
Mafra	14	1475 x 200	1200	909	910	1345	1475 x 380	75
Oslo	15	1370 x 220	1190	875	885	1270	1370 x 380	76
Radnor	16	1250 x 165	1070	770	775	1250	1370 x 400	75
Rembrandt	17	1350 x 126	1190	910	908	1350	1370 x 380	80
Seville	18	1220 x 200	1005	420	570	1110	1220 x 380	70
Stokesay	19	1375 x 245	1070	800	760	1240	1375 x 410	80
Stonehenge	20	1320 x 150	1155	910	890	1320	1370 x 380	35/76
Wave	21	1272 x 200	1113	872	843	1272	1372 x 400	80
Alderley	28	1331 x 208	1087	867	831	1270	1372 x 380	24/76
Ellington 46"	22	1170 x 200	1005	770	780	1095	1220 x 380	24/76
Ellington 54"	22	1372 x 215	1166	902	900	1280	1372 x 380	24/76
Hyacinth	25	1240 x 185	1074	750	817	NA	NA	NA
Jasmine	26	1324 x 211	1104	820	826	NA	NA	NA
Rothbury	29	1275 x 158	1122	760	862	1275	1372 x 380	24/76*
Sherburn 48"	23	1220 x 218	1051	810	801	1140	1220 x 380	24/76
Sherburn 54"	23	1372 x 216	1187	912	907	1282	1372 x 380	24/76
Waterford 48"	27	1220 x 182	1054	774	821	1147	1220 x 380	24/76
Waterford 54"	27	1355 x 186	1175	858	923	1240	1370 x 380	24/76
Wentworth	24	1422 x 200	1200	920	920	1314	1370 x 380	24/76

# Dimensions

ALL MEASUREMENTS ARE MM

Model	Page	Shelf	Overall Height	Opening Width	Opening Height	Base Width	Hearth	Rebate
Auckland	30	1248 x 172	1059	779	838	1159	1220 x 380	24/76
Berlin	33	1270 x 172	1095	870	880	1270	1370 x 380	24/76*
Henfield	31	1220 x 170	1022	794	794	1132	1220 x 380	24/76
Wylam	32	1225 x 156	1068	805	825	1142	1220 x 380	24/76
Galaxy	34	1180 x 188	905	920	430	1260	NA	NA
Jupiter	35	1110 x 345	810	600	345	1110	NA	NA
Orchid	37	1258 x 212	1120	623	708	1258	1258 x 350	25/76
Telstar	36	680 x 243	853	540	420	1064	1064 x 304	NA

\*Downlighters only available with a 76mm rebate



**Katell Limited**  
478-480 Durham Way North  
Aycliffe Industrial Park  
Newton Aycliffe, Co. Durham DL5 6HP

Tel: (01325) 379060

[www.katell.co.uk](http://www.katell.co.uk)



**Fireline**  
Unit D  
Stafford Park 2  
Telford, Shropshire TF3 3AR

Tel: (0845) 519 5991

[www.fireline.co.uk](http://www.fireline.co.uk)

## Charlton & Jenrick<sup>LTD</sup>

*Best of British fires, fireplaces & stoves*

Katell & Fireline are divisions of the Charlton & Jenrick Group  
[www.charltonandjenrick.co.uk](http://www.charltonandjenrick.co.uk)



@cJfires



[www.facebook.com/cJfires](http://www.facebook.com/cJfires)

Please note: Charlton and Jenrick Ltd fires' policy is one of constant development and improvement. Charlton and Jenrick Ltd therefore reserves the right to revise the specification and design of its fires without formal notice. This leaflet is presented as a guide to aid in your decision and does not replace the need for technical assessment by your dealer. Whilst the utmost care is taken in the preparation of this leaflet, it is not intended to replace the installation manual which provides more detailed information. Photography is for illustration purposes only and does not replace the need to see the surround in a showroom. We accept no liability for any loss or damage arising either directly or indirectly from the use of this leaflet. All designs in this brochure are design or copyright registered. Charlton and Jenrick Ltd, without exception, will take action against any infringements of their designs.