

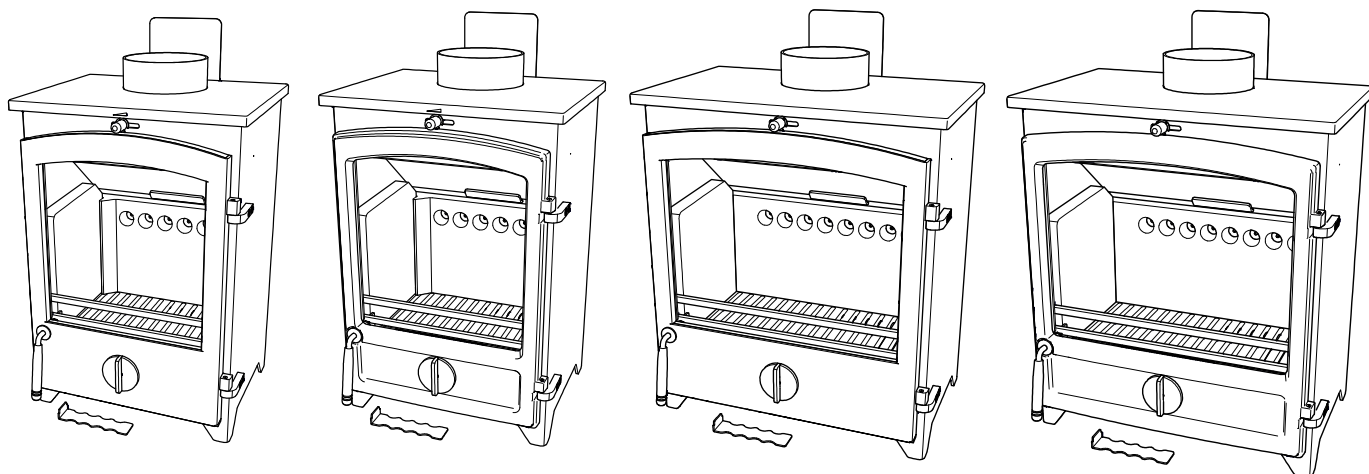

# Charlton & Jenrick Ltd

## GO ECO & GO ECO PLUS STOVES



Freestanding Stove Range  
5kW & 5kW Wide Nominal Outputs.

### With Patented $\pi$ i Air System

## Installation and Operating Instructions

Please hand these instructions to the stove user when the installation is complete. Leave the stove ready for operation and instruct the user in the correct use of the appliance and operation of controls.

**Important: – These products must be installed by a suitably qualified installer.**

#### Clean Air Act Exemption

The **CJ GO ECO & GO ECO Plus 5Kw, 5kw Wide** stoves only have been exempted under the Clean Air Act 1993 to burn seasoned wood logs in designated smokeless zones in the UK. This is subject to the correct fitting of the air control plate (the part and fitting instructions are packed separately) maintaining the air wash control at a minimum opening at all times. **Instructions for wood burning MUST be followed in order to ensure compliance at all times.**



Charlton & Jenrick Ltd  
Unit D Stafford Park 2, Telford, Shropshire, TF3 3AR  
T: 0845 519 5991 F: 0845 519 5992

A Charlton and Jenrick Group Company



**PLEASE READ ALL THESE INSTRUCTIONS CAREFULLY!**

For safety reasons it is essential that your stove is correctly installed and operated. Charlton & Jenrick cannot accept responsibility for any fault or consequential problems arising through incorrect installation or operation.

**TABLE OF CONTENTS**

<b><u>Section</u></b>	<b><u>Page No</u></b>
1. Contents.....	1
2. Component Identification and Controls.....	3
3. Preparation of Stove for Installation.....	4
4. Important Safety Information.....	5
4.1 Warnings and important safety information.....	5
4.1.1 Instructions.....	5
4.1.2 Chimney Warning.....	5
4.1.3 Extractor Fan Warning.....	5
4.1.4 Cleaning & Chimney Sweeping.....	5
4.1.5 Fuels.....	6
4.1.6 Maintenance.....	6
4.1.7 Ventilation.....	6
4.2 Health and Safety Information.....	6
4.2.1 Handling.....	6
4.2.2 Fire Cement.....	6
4.2.3 Asbestos.....	6
4.2.4 Metal Parts.....	6
5. Installation Information.....	6
5.1 Chimney & Flue.....	6
5.2 Ventilation.....	7
5.3 Flue Draught.....	7
5.4 Connection to Chimney.....	7
5.5 Material Clearance Dimensions.....	8
5.5.1 Distances from Combustible Materials.....	8
5.5.2 Distances from Non Combustible Materials.....	8
5.6 Hearths.....	8
5.7 Commissioning & Handover.....	10
6. Technical Data & Declaration of Performance.....	10

**Cont'd.....**

<b>7. Operating Instructions</b> .....	<b>11</b>
7.1 Safety Notes for your guidance.....	11
7.1.1 Fireguards.....	11
7.1.2 Modifications.....	11
7.1.3 Overfiring.....	11
7.1.4 Fume Emission.....	11
7.1.5 Chimney Fire.....	11
7.1.6 CO Alarms.....	11
7.2 Warnings.....	12
7.3 Clean Air Act (Smoke Control Zones).....	12
7.4 Air controls.....	13
7.4.1 Air Control Operation.....	13
7.4.2 Air Wash.....	13
7.4.3 Tertiary Air.....	13
7.4.4 Multifuel Grate.....	14
7.4.5 Ashpan.....	14
7.5 Cleaning.....	14
7.6 Fuels.....	14
7.7 Important Notes for Wood Burning.....	15
7.7.1 Refuelling on to a low Firebed.....	15
7.7.2 Fuel Overloading.....	15
7.7.3 Operation with Door Left Open.....	15
7.7.4 Primary Air Left Open.....	16
7.8 Notes on Smokeless fuel (Maxibrite) burning.....	16
7.9 Lighting the stove.....	16
7.10 Re-fuelling.....	17
7.11 Shutting down.....	18
7.12 Shutting down for prolonged periods.....	18
7.13 User Maintenance.....	18
<b>8. Maintenance Guide</b> .....	<b>19</b>
8.1.1 Removing Door.....	19
8.1.2 Removing Fuel Retainer.....	19
8.1.3 Removing Firebox Liners.....	19
8.1.4 Removing Baffle Plate.....	19
8.1.5 Removing Grate.....	19
8.1.6 Replacing Ceramic Glass Panel.....	19
8.1.7 Adjusting Door.....	19
8.1.8 Replacing Door Seals.....	19
8.1.9 Repainting.....	20
8.1.10 Reassembly.....	20
<b>9. Dimensions</b> .....	<b>21</b>
9.1 GO ECO & GO ECO Plus 5.....	21
9.2 GO ECO & GO ECO Plus 5 Wide.....	22
<b>11. Frequently Asked Questions</b> .....	<b>23</b>

## 2.0 Component Identification and Controls

### List of Components

Description of Parts	Qty
GO ECO Stove Assembly	1
Ashpan Tool	1
Ash Pan	1
Flue Spigot Collar (installed)	1
Flue Blanking Plate (installed)	1
Stove Operating Gloves	1

**Fig 1 – GO ECO Assembly and controls. 5 Plus model shown.**

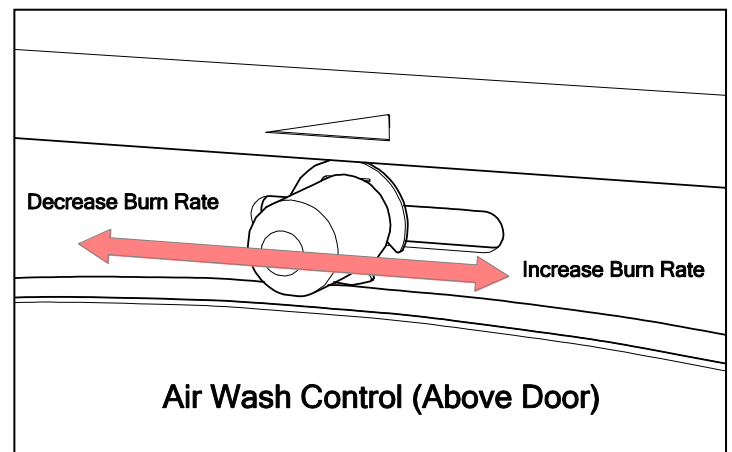
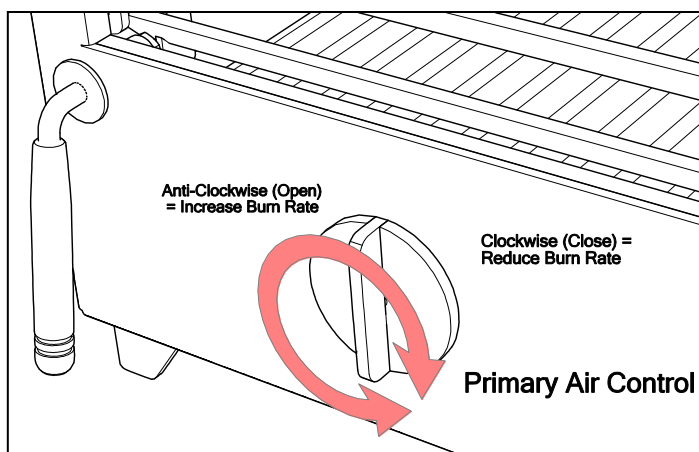
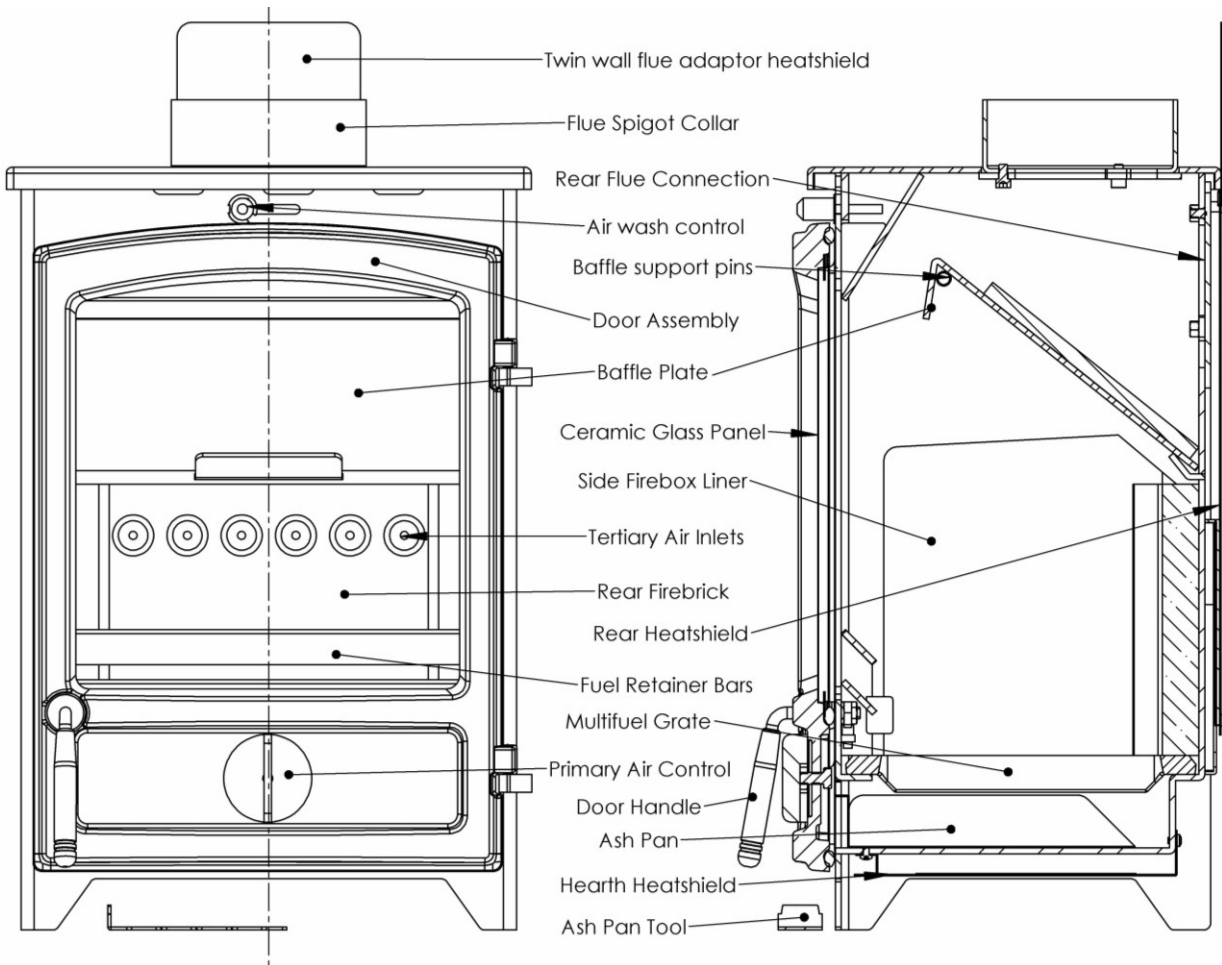

## **3.0 Preparation of Stove for Installation.**

**Your stove comes fully assembled, checked and packed in a protective plywood crate. Carefully remove the straps and lift off the top and upper crate. Remove any plastic packaging, open the door and remove all the contents. See List of Components section (above) and check contents carefully.**

- 3.1.** If required remove the stove door if required for easier handling of the unit – this is not normally required. Remove the retaining circlips on the bottom of the hinge pins. Open to about 30 degrees and lift upwards to disengage the hinge pins.
- 3.2.** Remove all the interior components of the stove using the following procedure. SEE ALSO MAINTENANCE GUIDE section.
  - 3.2.1.** Remove the baffle plate by supporting the plate with both hands and lifting the front edge towards you and sliding the back edge off the back support. Slots in the baffle should allow it to be lowered off the front baffle pins and into the firebox. There is a ceramic insulating board on top of the baffle plate – place this carefully to one side to avoid breakage. The plate can then be removed from the firebox.
  - 3.2.2.** Next remove the fuel retainer bars by lifting upwards until they can be disengaged from the side firebox liners and rotated slightly to bring out of the front of the firebox.
  - 3.2.3.** Remove the two cast ceramic firebox side liners by gently pulling the front edges forward and sliding away from the 45 degree mitre joint with the back liner at the rear corners. Take great care not to chip or damage the surfaces of these ceramic components – support the rear liner so that it cannot fall over and break!
  - 3.2.4.** Now remove the firebox rear liner. Handle and store these ceramic liners very carefully to one side where they will not get broken.
- 3.3.** The flue spigot collar may now be configured for vertical or horizontal connection as required.
  - 3.3.1.** Locate the 3 x M6 cap screws, 3 x nuts and the spigot which are packed in the firebox or ash pan section.
  - 3.3.2.** Fit the spigot to the top outlet or rear outlet using the gasket provided or fire cement to seal.
  - 3.3.3.** If required the blanking plate can now be used to cover the hole in the top plate or rear plate. Use the screws as studs and use the nuts on the threads to clamp the plate tightly against the gasket or use fire cement to seal.
- 3.4.** Lift the stove into its final position using an assistant to help.
- 3.5.** Make the connection to the flue, chimney or liner using appropriate rigid flue pipe or adaptor, making sure to seal all joints carefully.
- 3.6.** Now proceed to complete the installation of the stove according to these instructions, Building Regulations and current installation standards or HETAS competent person scheme advice.
- 3.7.** The internal parts of the stove can be re-assembled as the reverse of the previous removal instructions.

## **4.0 Important Safety Information**

### **4.1. WARNINGS AND IMPORTANT SAFETY INFORMATION**

#### **4.1.1. READ THESE INSTRUCTIONS CAREFULLY BEFORE INSTALLATION!**

These instructions cover the basic principles to ensure satisfactory installation of the stove, although detail may need slight modification to suit particular local site conditions. In all cases the installation must comply with current local regulations including Building Regulations, Local Authority Byelaws and other specifications or regulations including UK or EU standards referred to as they affect the installation of the stove. Approved Document J is particularly important for England and Wales and can be downloaded for no cost at:

<http://www.planningportal.gov.uk/england/professionals/en/400000000503.html> Also of importance are Approved Documents (A.D.) L1 A and B conservation of fuel and power. The Domestic Heating Compliance Guide will also be found useful.

In addition to these instructions the requirements of BS 8303 and BS EN 15287 must be fulfilled. The installation of a stove is a notifiable building works as defined in the building regulations and it is a legal requirement under England and Wales Building Regulations that the installation is either carried out under Local Authority Building Control approval or is installed by a Competent Person registered with a Government approved Competent Persons Scheme. HETAS Ltd operate such a Scheme and a listing of their Registered Competent Persons can be found on their website at [www.hetas.co.uk](http://www.hetas.co.uk).

#### **4.1.2. Important Chimney Warning**

This stove must not be installed into a shared chimney that serves any other heating appliance.

#### **4.1.3. Extractor Fan Warning**

There must not be an extractor fan fitted in the same room as the stove as this can cause the stove to emit fumes into the room. If unavoidable the appliance must be checked with Approved Document (A.D.) 1.21 and necessary action taken.

#### **4.1.4. Cleaning and Chimney Sweeping**

**The appliance, flue & chimney must be cleaned and checked internally and externally regularly in use and especially after a period of disuse (e.g. after summer).** Lift down the baffle at least weekly to check for build up of soot or debris on the top from the flue pipe. Remove the baffle and check the flue spigot and connector is fully clear at regular intervals. The chimney and flue connector must be swept at least annually, more often when used with sooty fuels or damp wood. The chimney or flue can usually be swept through the appliance. A wire centred sweeps brush with guide wheel is recommended. Any loose, broken or leaking joints or flue ways MUST be repaired immediately.

#### **4.1.5. Fuels**

Only use recommended fuels which are seasoned (or kiln dried) wood logs or smokeless briquetted fuels. The appliance can be damaged by burning petroleum coke, liquid fuels or general rubbish and this will invalidate your warranty and risk your personal safety. **The appliance must not be used as a rubbish incinerator.**

#### **4.1.6. Maintenance**

Annual checking and servicing of the appliance and flue by a competent engineer is recommended.

#### **4.1.7. Ventilation**

Adequate ventilation is ESSENTIAL for the safe and efficient operation of any solid fuel or wood burning appliance. Ventilation MUST be provided where required by the stove output or flue under-performance. Keep all ventilation clear and free of blockage, including the direct outside air connection where used. See VENTILATION in INSTALLATION INFORMATION section.

### **4.2. Health And Safety Precautions**

**Special care must be taken when installing this stove to meet all requirements of the Health & Safety at Work act.**

#### **4.2.1. Handling**

Adequate facilities must be available for unloading and site handling. Stoves are very heavily built so always ask for assistance when lifting and siting them. See Technical Data for weights.

#### **4.2.2. Fire Cement**

Some types of fire cement are caustic and should not be allowed to come into contact with the skin. In case of skin contact, wash immediately with plenty of water.

#### **4.2.3. Asbestos**

This stove contains no asbestos. If there is a possibility of disturbing any asbestos in the course of installation then please seek specialist guidance and use appropriate protective equipment.

#### **4.2.4. Metal Parts**

When installing or servicing this stove, proper care should be taken to avoid the possibility of personal injury. Injury may be caused by component weight, sharp parts or trapping for example and these risks should be identified and minimised.

## **5.0 Installation Information**

### **5.1. Chimney/flue**

The chimney height and the position of the chimney terminal should conform to Building Regulations. Minimum chimney height is 4.5m and the recommended minimum diameter is 150mm wherever possible for safety margin and performance. The chimney must be swept before connection to the stove. Check that the chimney is in good condition, dry and free from cracks and obstructions. The diameter of the flue should not be less than 125mm (spigot diameter) at any point and not greater than 200mm. If any of these requirements are not met, the chimney should be lined by a suitable method. When using a liner a 5" flexible flue liner is permitted be used on these stoves providing that the users only burns smokeless fuel or seasoned wood logs with the air limiter fitted in in full accordance with the wood burning instructions.

Where the chimney is believed to have previously served an open fire installation, it is possible that the higher flue gas temperature from the stove may loosen deposits that were previously firmly adhered, with the consequent risk of flue blockage. It is therefore recommended that the chimney be swept a second time within a month of regular use after installation.

If you have any doubts about the suitability of your chimney, consult your local dealer/stockist or chimney specialist. If there is no existing chimney then either a solid fuel compatible prefabricated block chimney or a twin-walled insulated stainless steel flue to BS 4543 can be used. These chimneys must be fitted in accordance with the manufacturer's instructions and Building Regulations.

## **5.2. Ventilation**

Document J of the Building Regulations states that (except in recently built properties) purpose provided ventilation is not required in England and Wales unless the appliance nominal rated output is greater than 5kW. Over 5kW 5.5 cm<sup>2</sup> of ventilation (550mm<sup>2</sup>) is required for every kW output above 5. For example 6.5 kW requires 8.25 cm<sup>2</sup> and 8 kW needs 16.5cm<sup>2</sup>. In any case, if difficulty in starting the fire or any excessive fuming is experienced, ventilation must be put in place as required to eliminate these flue problems. If a flue draught stabiliser is fitted then extra ventilation is required. See Document J of the Building Regulations for detailed guidance especially in new build properties where purpose provided ventilation may be required.

## **5.3. Flue Draught**

Typically a flue draught at the flue collar of minimum 2.2mm to a maximum 3.5mm water gauge (22 to 35 Pascals) is required for satisfactory appliance performance. This relates to 12-25 Pascals at the tapping on EN13240/13229 test rigs. The flue draught should be checked under fire at high output and, if it exceeds the recommended maximum, a draught stabiliser must be fitted so that the rate of burning can be controlled to prevent over-firing.

## **5.4. Connection to the Chimney**

This appliance is **not** suitable for use in a shared flue.

Whilst 150mm diameter flue or liner is recommended wherever possible, a suitable 5" flexible flue liner is permitted be used on these stoves providing that they only burn smokeless fuel or seasoned wood logs with the air limiter fitted in in full accordance with the wood burning instructions.

An existing fireplace opening can be bricked up or sealed with a register plate. A short length of suitable quality rigid flue pipe of a minimum 125mm internal diameter may then be used to connect the stove to the chimney. A maximum of 150mm horizontal flue pipe can be used. This flue pipe should conform to Building Regulations. If the connecting pipe enters the vertical flue way at any other angle except vertically, ensure that the pipe end is no closer (along the axis direction of the pipe) than 76mm to the side or rear chimney walls. Ideally, the old fireplace should be filled in so that there is a smooth streamlined entry into the flue way. It is essential that all connections between the stove and chimney-flue are sealed and made airtight with sealing rope, clamping rings and/or fire cement or heat resisting cement where required.

Both the chimney and flue pipe must be accessible for cleaning and if ANY parts of the chimney cannot be reached through the stove (with baffle removed), a soot door must be fitted in a suitable position to enable this to be done.



## 5.5. Material Clearance Dimensions

### 5.5.1. Safety Distances from Combustible Surfaces:

#### **FREESTANDING MODELS**

<b>Model</b>	<b>Side (Full wall)</b>	<b>Rear <i>Single Wall Flue</i></b>	<b>Rear <i>Twin Wall Flue</i></b>
<b>GO ECO 5kW (inc Plus)</b>	700mm (From Top Plate)	450mm (From Top Plate)	300mm (From Heatshield)
<b>GO ECO 5kW Wide (inc Plus)</b>	700mm (From Top Plate)	550mm (From Top Plate)	300mm (From Heatshield)

In addition it is strongly recommended that any furniture or other combustible materials are kept at least 900mm clear from the front of the stove.

NOTE: Combustible surfaces can be protected from radiant heat from the stove by adding non-combustible heat shielding between the stove and the materials with an air gap behind it. By doing so, safe distances may be substantially reduced in practice.

#### **COMBUSTIBLE SHELVES AND BEAMS**

Due to the fact that combustible shelves, timber fireplaces and beams have potentially thousands of possible configurations in conjunction with stoves outset or inserted partially or fully into chambers, it is not possible to give firm guidance on dimensions to these features. As a guideline, materials that are in 'line of sight' to the stove are more likely to overheat due to direct radiation from the stove body than materials that are not in 'line of sight' (e.g. with stove fully inside a chamber). Materials above the stove are far more likely to overheat than materials alongside or below. A guideline limiting temperature for solid timber (not surface finishes) is approximately 80-85 degrees C with a normal ambient room temperature. Temperatures of combustible materials can be substantially lowered with a simple heat shield constructed of a non-combustible material and small air gap (6-12mm for example) between the shield and combustible material.

### 5.5.2. Distances from NON-combustible materials:

The stove can be recessed in a suitable sized non-combustible fireplace but a permanent free air gap of at least 50mm must be left around the sides and top and at least 50mm at the back of the stove to obtain reasonable heat output and for access to the stove for removal and maintenance. A clearance of 150mm will give a better heat output

In accordance with Building regulations all non-combustible walls closer than 400mm to the stove should be at least 75mm thick. For practical reasons the back wall of the fireplace recess and the hearth should be made of non-combustible material.

## 5.6. Hearths:

These stoves do not require a constructional hearth beneath them as they do not cause the floor temperature to exceed 100 degrees C. Hearths must be generally level. In all instances a non-combustible superimposed hearth extending fully underneath the stove and forming an apron of at least 225mm at the front of the stove and 150mm on either side must be provided. The superimposed hearth must not be less than 12mm thick and must have a clearly defined edge (change of level) to discourage placing of any combustible materials on or partially over it.

The appliance shall be installed on a floor with adequate load-bearing capacity. If the existing construction does not meet this requirement, suitable measures (e.g. load distributing plate) should be provided to achieve it.

### 5.7. Commissioning and Handover

CO Alarm: Building Regulations require that whenever a new or replacement fixed solid fuel or wood/biomass appliance is installed in a dwelling a carbon monoxide alarm must be fitted in the same room as the appliance. Further guidance is available in BS EN50292:2002 and from the alarm manufacturer's instructions. Provision of an alarm must not be considered a substitute for either installing the appliance correctly or ensuring regular servicing and maintenance of the appliance and chimney system.

Upon completion of the installation, allow a suitable period of time for any fire cement and mortar to dry out. A small fire may then be lit and checked to ensure the smoke and fumes are taken from the stove up the chimney and emitted safely to atmosphere.

Advise the customer not to run the stove at full output for at 3 – 4 days. Explain that the stoves can provide much more or less output than their rated heat outputs depending upon fuels, fuel loads used and how they are operated.

**Warn the customer that using excessive air (having the air controls open too wide for too long with a full fuel load) can over-fire and irreparably damage the stove. Damage caused by over firing is NOT covered by any warranty.**

On completion of the installation and commissioning, check all parts of the appliance are correctly fitted and ensure that the operating instructions and operating tools (including gloves) for the stove are left with the customer. You must be sure to advise the customer on the correct use of the appliance with the fuels likely to be used on the stove and warn them to use only the recommended fuels for the stove.

Advise the user on what to do should smoke or fumes be emitted into the room from the stove – see **Safety Notes** section. The user should be warned that they **MUST** use a suitable fireguard in the presence of children, aged and/or infirm persons.

## 6.0 Technical Data & Declaration of Performance (DoP)

**Manufacturer:** Charlton & Jenrick Ltd.

**Range Designation:** GO ECO freestanding stoves.

**Models:** GO ECO 5, 5 Wide, 5 Plus and 5 Wide Plus with nominal outputs of 5kW.

**Intended Use:** Domestic heating appliances

**Independently Performance & Safety tested by:** Kiwa Gastec, Notified Body No: 0558

**Constancy of Performance System:** ISO9001

Model	Go Eco and Go Eco Plus 5	Go Eco and Go Eco Plus 5 Wide	Notes
Appliance weight (packed/unpacked) (Kg):	60/50 63/53	70/59 74/63	
Approximate Output Range: (kW)	3.8 – 6.7	4.1-7.0	
Harmonised EN European Standard (hEN):	EN13240: 2001 Amd 2: 2004	EN13240: 2001 Amd 2: 2004	
Additional Characteristics Test Standard:	DIN +	DIN +	
Additional Particulate Emission Test Standard:	PD6434	PD6434	
Performance Characteristics using Wood Fuel			
Test Report Issue Date:	04/17	04/17	
Total Efficiency: (%)	82.5	79.8	
Declared nominal output: (kW)	5	5	
Tested nominal Output: (kW)	5.1	5	
Tested wood re-fuelling interval: (h)	0.81	0.79	
Flue gas mass flow: (g/s)	3.6	4.2	
Mean CO emission (@13% O <sub>2</sub> ): (%) (Nmg/m <sup>3</sup> )	0.06 (750)	0.09 (1125)	
Mean C <sub>n</sub> H <sub>m</sub> emission (@13% O <sub>2</sub> ): (Nmg/m <sup>3</sup> )	37	46	
Mean NO <sub>x</sub> emission (@13% O <sub>2</sub> ): (Nmg/m <sup>3</sup> )	101	92	
DIN+ particulates (@13% O <sub>2</sub> ): (Nmg/m <sup>3</sup> )	10	11	
PD6434 Particulate Emissions High output: (gh <sup>-1</sup> )	3.6	1.9	
PD6434 Particulate Emissions Low output: (gh <sup>-1</sup> )	1.9	1.5	
Optical Density Time > 0.2 High (Mins)	1.1	0.4	
Optical Density Time > 0.2 Low (Mins)	0.7	0.0	
*Mean Flue Temperature: (Deg C)	270	276	
Approximate Max Log Length: (mm)	250	350	
Performance Characteristics using Maxibrite Fuel			
Total Efficiency: (%):	77	78.7	
Declared nominal output: (kW)	5.0	5.0	
Tested nominal output: (kW)	5.0	5.0	
Tested re-fuelling interval: (h)	1.03	1.03	
Flue gas mass flow: (g/s)	4.0	3.2	
Mean CO emission (@13% O <sub>2</sub> ): (%) (Nmg/m <sup>3</sup> )	0.06 (720)	0.02 (250)	
Mean C <sub>n</sub> H <sub>m</sub> emission (@13% O <sub>2</sub> ): (Nmg/m <sup>3</sup> )	8	2	
Mean NO <sub>x</sub> emission (@13% O <sub>2</sub> ): (Nmg/m <sup>3</sup> )	131	91	
DIN+ particulates (@13% O <sub>2</sub> ): (Nmg/m <sup>3</sup> )	15	13	
Mean Flue Temperature: (Deg C)	314	327	
Clearances from Combustible Materials			
Side Wall: (mm)	700	700	
Rear Wall: (mm)	450/300	550/300	

Signed:



Peter Mintoft  
Director  
April 2017

**NOTE:** Refuelling intervals for testing are chosen according to the standards concerned for performance testing and are comparative only. They **do not** relate directly to re-fuelling intervals that can be achieved on an installed product. Re-fuelling intervals of 1-1.5h for wood and 3-4+ hours for briquetted smokeless fuels would be more usual. Under normal conditions on a low air control setting stoves should stay in overnight on suitable briquetted smokeless fuel.

## 7.0 Operating Instructions

### 7.1. Safety Notes for your guidance

**7.1.1. FIRES CAN BE DANGEROUS** – Always use a fireguard to BS 8423:2002 Fireguards for use with solid fuel appliances in the presence of children, the elderly or the infirm.

**7.1.2. DO NOT perform modifications to the appliance as this could seriously compromise safety in operation.**

**7.1.3. DO NOT OVERFIRE** – it is possible to fire the stove beyond its design capacity, this could buckle parts and damage the stove, so watch for signs of over firing – if any part of the stove starts to glow red, including baffle plate or fuel retainer, the fire is in an over fire situation and the controls should be adjusted accordingly. Never leave the stove unattended for long periods without first adjusting the controls to a reduced and safe setting – **careful air supply control should be exercised at all times.**

#### **7.1.4. WARNING – FUME EMISSION**

Properly installed and operated, this appliance will not emit fumes. Occasional fumes from de-ashing and refuelling may occur which is not normally of serious concern. **However, persistent fume emission is potentially dangerous and must not be tolerated.**

If fume emission does persist, then the following immediate action should be taken: -

1. Open doors and windows to ventilate room
2. Let the fire out, or remove and safely dispose of fuel from the appliance.
3. Check for flue chimney blockage and clean if required.
4. Do not attempt to re-light the fire until the cause has been identified and corrected.

If necessary, seek professional advice from chimney or stove specialists.

**Important!** – Do not fit an extractor fan in the same room as this appliance.

#### **7.1.5. IN THE EVENT OF A CHIMNEY FIRE**

- Raise the alarm to let others in the house know.
- Call the Fire Service
- Reduce the appliance burning rate by closing all air controls fully.
- Move furniture and rugs away from the fireplace and remove any nearby ornaments.
- Place a fireguard or spark guard in front of the stove.
- Feel the chimneybreast for sign of excessive heat.
- Do not relight the fire until the chimney and flue ways have been examined by a professional.

If the wall is becoming hot, move the furniture away. Ensure that the Fire Service can gain access to your roof space in order to check this area for signs of fire spread.

#### **7.1.6. CO ALARMS**

Your installer should have fitted a CO alarm in the same room as the appliance. If the alarm sounds unexpectedly, follow the instructions given under “Warning Note” below.

WARNING If the CO Alarm sounds unexpectedly:-

1. Open Doors and windows to ventilate the room and then leave the premises.
2. Let the fire go out.

## 7.2 Warnings:

This appliance is **not** designed for open operation and therefore should **not** be operated with the doors open.

This stove is designed to burn wood and smokeless fuels cleanly with high efficiency. However, for this product to work properly it must be used correctly. If used correctly this stove will burn with the very useful feature of clean glass.

It is **essential** that the stove has an adequate air supply for combustion and ventilation. DO NOT block any ventilators provided. The primary, secondary and tertiary air inlets must be kept clear of obstruction.

**Warning!** This appliance will be very **hot** when in operation and due care should be taken when operating the controls. A tool and pair of quality leather gloves are provided to assist safe operation.

Do not use an aerosol spray on or near the stove when it is alight.

## 7.3 The Clean Air Act 1993 and Smoke Control Areas

Under the Clean Air Act local authorities may declare the whole or part of the district of the authority to be a smoke control area. It is an offence to emit smoke from a chimney of a building, from a furnace or from any fixed boiler if located in a designated smoke control area. It is also an offence to acquire an "unauthorised fuel" for use within a smoke control area unless it is used in an "exempt" appliance ("exempted" from the controls which generally apply in the smoke control area).

In England appliances are exempted by publication on a list by the Secretary of State in accordance with changes made to sections 20 and 21 of the Clean Air Act 1993 by section 15 of the Deregulation Act 2015. Similarly in Scotland appliances are exempted by publication on a list by Scottish Ministers under section 50 of the Regulatory Reform (Scotland) Act 2014. In Northern Ireland appliances are exempted by publication on a list by the Department of Agriculture, Environment and Rural Affairs under Section 16 of the Environmental Better regulation Act (Northern Ireland) 2016. In Wales these are authorised by regulations made by Welsh Ministers.

The Charlton & Jenrick Go Eco 5, Go Eco 5 plus, Go Eco 5 Wide and Go Eco 5 Wide plus stoves have been recommended as suitable for use in smoke control areas when burning wood logs. This is conditional upon fitting the supplied secondary air control limiters and following the wood burning instructions precisely. Suitable Authorised fuels can also be used in the appliances in Smoke Control Areas (see Authorised fuels for use in Smoke Control Areas here <https://smokecontrol.defra.gov.uk/fuels.php> ).

Further information on the requirements of the Clean Air Act can be found here: <https://www.gov.uk/smoke-control-area-rules> . Your local authority is responsible for implementing the Clean Air Act 1993 including designation and supervision of smoke control areas and you can contact them for details of Clean Air Act requirements.

## 7.4 Air Controls

**Keep air controls and inlets/outlets clean and free from ash or debris at all times. Keep ventilator air inlet grille (if fitted) clean and clear at all times.**

**Do not leave air controls fully open unless monitoring the fire as over firing damage (typically bucking of components) can result which is not covered by any warranty.**

### 7.4.1 Air Control Operation

**Primary (under grate) air** is controlled by the spinner on the lower part of the door. Secondary (air wash) air is controlled by the slider above the door. Tertiary air is controlled by draught through pre-set intakes at the back of the stove body. The open position for the Primary air spinner should only be used for smokeless fuel operations, it is not necessary at all for wood burning. The closed position of the air wash control should only be used if absolutely necessary for very slow burning and when burning wood will cause the glass to become blackened, the chimney to gradually become tarred and smoke to be emitted from the stove.

**Wood burning:** Move the air wash slider fully to the right (open) for maximum air to start or revive a wood fire. Returning the lever towards the centre position will reduce the air supply progressively to reduce the burn rate. The nominal burn rate is usually achieved when the stove is fully warmed up (2-3 loads of logs) and burning dry hardwood logs by having the lever very approximately 10mm from the closed position. This is only a rough guide as flue and fuel conditions will vary the required position. The fire will automatically be supplied with the correct mix of tertiary air for complete combustion. The maximum position conveniently provides a boost of primary air as well to get new fuel burning quickly in order to minimise smoke. Do not leave on maximum setting unless monitoring the fire to ensure over firing damage does not occur. **NOTE: It is not necessary to open the primary air at all once the stove is warmed up when burning wood unless the flue draught or wood moisture are out of specification.** Doing so may over fire the stove.

**Smokeless coal fuel burning:** Move the air wash control slider fully to the right side and open the primary air spinner on the door fully for starting or reviving a coal fire. Returning the air wash lever towards the closed position will reduce the air supply progressively and improve the efficiency for burning smokeless fuels as the fire warms up. Also reduce the primary air control if required to regulate heat output. Do not leave on maximum setting unless monitoring the fire to ensure over firing damage does not occur. **NOTE: It is not necessary to open the secondary air slider more than 3-4mm once the stove is warmed up when burning smokeless coals. Doing so will keep the glass slightly cleaner but will reduce thermal efficiency.**

### 7.4.2 Air Wash

All Charlton & Jenrick stoves are provided with a sophisticated "air wash" system to assist in keeping the fire as visible as possible and reducing (not eliminating) cleaning intervals. This secondary air supply to the stove is controlled through the slider knob above the door. The Clean Air Act air restrictor bracket will deliberately prevent full closure of this control on the Wood side of operation. To fix the control in a particular position it can be screwed down until tight. Slacken slightly until free enough to move when adjustment is required. The screw cannot come off the end of its thread but leaving it too slack can lead to air going around the slider with reduced effectiveness - so maintain it just loose enough to slide smoothly.

### 7.4.3 Tertiary Air

This appliance is also fitted with a patented tertiary air combustion system that burns otherwise uncombusted gasses in the products of combustion thereby improving efficiency, increasing heat output and decreasing unwanted atmospheric emissions. The Tertiary air supply to the

stove is controlled automatically by the draught in the flue and firebox. At certain stages of burning you will notice “jets” of swirling flame emerging near the air holes to the rear of the firebox. This is not always visible depending upon the fuels and burn cycle stage so there is nothing untoward happening if it cannot be seen.

#### **7.4.4 Multifuel Grate**

Your stove is fitted with a multifuel grate, which can be de-ashed by GENTLY using a poker or ash rake. The grate is a strong set of cast iron bars with suitable air slots that assist the burning of most fuels. When burning coal type fuels it is important to de-ash regularly to ensure that the primary airflow is not impeded. An excessive build-up of ash *when burning coal* can damage the cast iron grate. A build up of wood ash when burning wood will not harm the grate and indeed wood is said to burn well on a bed of ash but excessive wood ash build up is not recommended.

#### **7.4.5 Ashpan**

It is essential that you empty the ash pan regularly when burning coal type fuels. Use the flat end of tool to lift the ash pan out of the stove. DO NOT allow coal ash to build up underneath the bed as this may cause damage to the grate.

### **7.5 Cleaning**

**Glass:** Despite the advanced air wash system provided, the glass will still need cleaning from time to time depending on the fuel quality and burning rates used. Never clean glass when the stove is hot. Always use stove glass cleaner or ceramic hob cleaner, which is available from your stove retailer or supermarket. As an alternative, use a wet cloth with some of the wood ash if burning wood but be very careful to use very clean ash so as not to scratch the glass. DO NOT use coal ash to clean the glass.

**Outer body:** The outer body simply needs to be dusted or wiped with a clean cloth from time to time. DO NOT use wet cloths as it can spread plaster, cement, fire cement or fire board dust and subsequently cause the paint to turn grey with heat where it has been wiped. DO NOT use any kind of furniture polish or cleaning agent other than your stove suppliers recommended paint.

**Inner firebox:** Brush the inside of the firebox clean from time to time to check the integrity of the plates and liners etc. See Maintenance Guide section for instructions on how to remove parts of the stove. It is not normally necessary to re-paint inside the firebox due to the high temperatures that mean that the paint does not have much effect before being burnt off. Steel and cast firebrick liners are very resilient firebox materials and will give reliable service without major cleaning or work on the firebox. The liner bricks may require replacement occasionally depending upon fuels and the type of usage experienced. Firebox linings are able to continue in service with cracks or repairs by fire cement, as long as the steel underneath is not exposed to the fire. Firebox linings are not covered by warranty, as they are a wearing consumable part.

**Baffle:** It is essential to check the top of the baffle for build up of soot and ash regularly when in use and after a long period of disuse – e.g. summer. From time to time remove the baffle if necessary to ensure that the flue way entrance is clear. Baffle plates will require replacement from time to time and are a wearing consumable part.

**Air Supply:** It is essential to check any air supply ventilator in the property is fully clear and open if installed.

### **7.6 Fuels**

The appliance is fitted with a versatile multifuel grate and the appliance has been tested and approved burning dry, well-seasoned logs (<20% moisture) or briquetted Maxibrite smokeless fuel. These are the recommended fuels. For other fuels please contact the manufacturer for advice.

**Note: Warning!- Petroleum coke fuels or household waste must not be burnt on this appliance.**

Should any difficulties arise over fuel quality or suitability, consult your local approved fuel merchant.

### **7.7 Important Information for Wood Burning**

With a full load of wood and burning near nominal output the stove will need to be refuelled approximately every 45 min to 1.5 hours. One or two large logs will burn longer and cleaner than a number of smaller ones. Wood can usually be stacked higher in the stove than solid mineral fuel but care must be taken that logs do not touch the baffle or the glass panel. **Do not stack logs above the level of the rear firebox liner brick at the back of the stove.**

Always make sure that flames are visible above the wood after re-fuelling for cleanest burning. **Burning without flames above the fuel will create unnecessary smoke and poor heat output.** **After re-fuelling open the air wash control fully to the right side for 3 minutes or until the logs are fully blackened to achieve full flames above the fuel.**

Wood burns well on a bed of ash and it is therefore only necessary to remove surplus ash from the stove occasionally.

Burn only dry, well-seasoned wood, which should have been cut, split and stacked - under cover from rain - for at least 12-24 months with free air movement around the sides of the stack to enable it to dry out. Burning wet or unseasoned wood will create tar deposits in the stove and chimney and will not produce a satisfactory heat output. **Wood that is not properly dry ('dry' is considered to be less than 20% internal moisture content) uses up energy from the burn process to evaporate the water inside the wood thus creating very poor conditions for combustion.** The main cause of burning problems with wood stoves is due to excessively damp wood. Wood can appear perfectly dry on the outside but still contain 40-50% water on the inside. A moisture meter can be purchased from stove and equipment suppliers if you wish to check your wood source is correct. Split a log and check the inside as well as the outside.

#### **7.7.1 Refuelling on to a low fire bed**

If there is insufficient burning material in the firebed to light a new fuel charge, excessive smoke emission can occur. Refuelling must be carried out onto a sufficient quantity of glowing embers and ash so that the new fuel charge will ignite in a reasonable period. If there are too few embers in the fire bed, add suitable kindling and firelighter if necessary to prevent excessive smoke.

#### **7.7.2 Fuel overloading**

The maximum amount of fuel specified in this manual should not be exceeded, overloading can cause excess smoke. Never load fuel above the back firebrick firebox liner or allow them to touch the glass. All models max log diameter = approx. 150mm. Max length = 250mm for 5 and 5 plus, 350mm for 5 Wide and 5 Wide Plus models. One log is acceptable ONLY if loading onto a hot, well established fire bed.

#### **7.7.3 Operation with door left open**

Operation with the door open can cause excess smoke and spillage into the room. The appliance must not be operated with the appliance door left open.



#### 7.7.4 Primary Air left open

Operation with the primary air controls left open: The air spinner on the door can create excess smoke and over-fire the stove if left open when burning wood. Leaving the door ajar when hot can also cause over firing and smoke emissions.

#### 7.8 Information on Smokeless Fuel (Maxibrite) burning

Maxibrite, briquetted smokeless and smokeless coal type fuels require very different burning conditions to log burning and the stove has been designed to allow for this. Use the bottom air control on the lower part of the door and very little air wash air (slider above the door almost closed) for best efficiency on these types of fuel. Maxibrite and other smokeless briquetted fuels can burn with very little primary air and stay in for many hours to be revived after an overnight burn for example. NEVER use household or any grade of smoky coals.

#### 7.9 Lighting the Stove

We recommend that you have two or three small fires before you operate your stove to its maximum heat output. This is to allow the paint to cure in steadily and to give a long service life of the paint finish. During this curing in process you may notice an unpleasant smell whilst the finishes finally cure. It is non-toxic, but for your comfort we would suggest that during this period you leave all doors and windows open.

First, open the air wash slider control fully to the right side and open the primary air control by unscrewing anti-clockwise fully (about 3 full turns). Load the firebox with some fully dry small logs or split logs in a crossed pattern. Make sure the grate is well covered and no big gaps are present.



Next add plenty of dry kindling sticks and a firelighter ON TOP of the 4 logs. A crib lattice pattern tends to work well. If using Maxibrite, place a layer of Maxibrite into the firebox on the base as well and omit the large logs but use plenty of kindling so that the charcoal from the wood ignites the Maxibrite well.

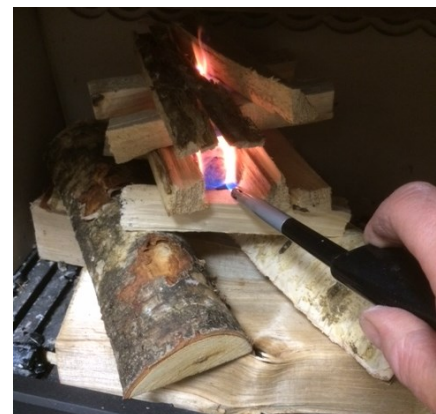

Light the firelighter(s), leaving the air controls fully open and close the door. It should not be necessary to leave the door open but DO NOT leave the stove unattended if you find it necessary to leave the door ajar.

The kindling will burn and set light to the logs by radiation and breaking down to charcoal gradually and with fewer emissions than the traditional logs on top methods.



Allow the fuel to reach a steady burn and usually the initial fuel can be left to burn down to charcoal without much further attention. Next build the fire up carefully by adding a couple of small split logs or an amount of Maxibrite briquettes at a time. Do not overload the fire bed with more than two or three small logs at a time.



Once you have a good fire bed established across the grate, further fuel can be added step by step as required. Don't be tempted to overload the fire bed with fuel all at once or close down the air controls until the fire is really well established for some time. Once the ignition period is well under way, gradually reduce the air controls then fully close the primary air if burning wood and use the

controls to establish the burning intensity you require.

### **7.10 Re-fuelling**

When burning Maxibrite the fire will begin to die down with a significant amount of white ash showing amongst the fuel. Shake the grate using the shaker and then *gently* run a poker through the fire bed to remove most of the ash into the ashpan. Empty the ashpan if it is nearly full and then re-fuel with a good load of briquettes. The fuel load should initially be level with the top of the fuel retainer and not above the rear firebox liner tertiary air inlet profiling. Whilst approval test cycles are 1 or 2 hours, a stove burning Maxibrite may be kept in overnight easily under normal conditions.

When burning wood, the fire will die down as the fuel is consumed. When the flames disappear and the remainder is breaking down into glowing embers it is an appropriate time to consider re-fuelling. Generally unless the firebox and firebed has cooled down and it is being revived up to working temperature then it's not appropriate to re-fuel when the logs are still flaming fiercely. NOTE: If the flames disappear and there are still lumps of solid wood left this indicates excessive internal moisture in the wood, too low a firebox temperature (running too cool), too small a fuel load or insufficient air supply/flue draught.

**NOTE:** To eliminate unwanted smoke emission, after loading new logs on to the fire, open the air wash control up fully for 3 minutes or until the logs are blackened all over to boost the fire and get flames issuing from the top of the fuel as soon as possible. When flames are well established, reduce the air wash to the running setting required. **Burning without flames above the fuel will create unnecessary smoke.** Do not load fuel above the rear firebrick at the back of the firebox.

Loading 1 or 2 medium-large sized logs weighing 1-2kg DRY will produce a good output with reasonable burn time. Small logs will burn up quicker producing a high output and more emissions for a short time, and a large log will take longer to burn and produce less output and less emissions over a given time. These appliances are approved for intermittent operation on wood (typically 0.75 to 1.5 hour burn cycles) although longer burn times can be achieved by fully loading the firebox, getting the fuel burning well and then shutting the air controls right down (see below). This will produce a long but smoky/tarry burn. The fire will then need reviving by first opening the air controls and then using small pieces of wood and plenty of air to get flames issuing from the wood again. Never load fuel above the rear firebrick or allow it to spill onto the glass.

### **7.11 Shutting Down**

The stove will normally shut down by itself as the fuel is consumed so there is no need to close the air control towards the end of the burn. In order to shut down the stove for other reasons, close air controls. If the controls are left in this position, the fire will eventually go out but it will also cause the glass to blacken/grey out as the fire dies down. If you want to revive the fire it is recommended that the air controls are opened fully initially.

**Warning!** - The stove will remain **very hot** for a considerable time after the fire has died down or been extinguished.

### **7.12 Shut down for prolonged periods**

If the stove is to be left unused for a prolonged period of time then it should be given a thorough clean to remove ash and unburned fuel residues. To enable a good flow of air through the appliance to reduce condensation and subsequent corrosion damage, leave the air controls open. It is important that the flue connection, any appliance baffles or throat plates and the chimney are swept prior to lighting up after a prolonged shutdown period.

### **7.13 User Maintenance**

See also the Cleaning section above and Maintenance Guide Section below for further information.

Inspect the inside of the firebox and above the baffle plate every week during use.

Where the chimney is believed to have previously served an open fire installation, it is possible that the higher flue gas temperature from the stove may loosen deposits that were previously firmly adhered, with the consequent risk of flue blockage. It is therefore recommended that the chimney be swept a second time within a month of regular use after installation. **See chimney cleaning section in section Warnings and Important Information.** Inspect the inside of the stove and the flue ways and ensure they are 100% clear after a period of disuse (e.g summer).

Check all rope seals and glass gasket seals for completeness, wear and that there are no gaps between the ends etc. Any gaps must be eliminated and ropes must be re-adhered to their grooves with suitable rope seal cement where required. **Worn or missing rope or glass gasket seals will affect appliance operation, control and emissions output and can lead to overheating damage.**

Check all air intakes and outlets within the stove for cleanliness and remove any ash or debris build up by suitable means.

Check outside air ventilators and stove air inlets are clean and unobstructed.

**Only use manufacturers recommended replacement parts on the appliance.**

## 8.0 Maintenance Guide

- 8.1.1 Removing Door.** Remove the stove door by firstly removing the securing circlips from the bottom of each hinge pin. Use narrow nose pliers and keep the clips safe to re-fit later. Open the door to approximately 30 degrees and lift away to disengage the hinge pins. Note that it is not necessary to remove the door to clean or remove items from inside the firebox.
- 8.1.2 Removing Fuel retainer bars:** The fuel retainer bars also retain the side firebrick liners. Lift bar assembly up until they can be rotated above the side firebrick liners and removed from the firebox.
- 8.1.3 Removing Firebox Liners:** Gently move either side firebrick forwards and slightly towards the centre of the grate to release them from the rear liner. There is a mitre joint at the rear which retains both when in position and when disengaged frees all components. **NOTE: Make sure the rear firebrick does not fall forwards and break as the side liners are released!**
- 8.1.4 Removing Baffle Plate:** Slide the baffle plate slightly towards the front of the stove and lower it off the front support pins and rear support. Rotate the baffle slightly and retrieve the ceramic insulation board from the top of it. Remove through the front of the stove.
- 8.1.5 Removing the grate:** Remove the fuel retainer, firebrick liners and baffle as above and then lift out the grate assembly castings from the stove firebox.
- 8.1.6 Changing the ceramic glass panel:** From time to time the ceramic glass panel or its gasket seals will need to be changed. Note that ONLY ceramic stove glass in the same thickness can safely be used. This is easiest to accomplish with the door removed from the stove and placed face down on a cushioned surface such as cardboard or a folded dust sheet. Firstly clean the inside surfaces of the door and remove the 4 x M5 stainless screws that secure the stainless steel glass clips to the door. The glass panel can then be carefully removed. Take the opportunity to clean the glass panel thoroughly if it is to be re-used. Remove all traces of seal from the door casting and clean the surfaces ready for new seals. The paper seal strip materials are ceramic and highly temperature resistant but delicate. Fit new seals into place forming a continuous glass seal all around the panel seating area. Line up carefully with a small overlap in the corners leaving NO GAPS. Replace the glass panel into position followed by the clips and screws. A strip of gasket material between each metal clip and the glass can extend glass panel life by spreading compression forces evenly. Tighten the four screws in turn to gradually compress the new gaskets and seal the new panel into position.
- 8.1.7 Adjusting door:** Adjustment can be made to the door latch and hinges. To adjust the door latch, firstly slacken the outer nut on the end of the spindle. Then to tighten door closing up, turn the inner nut clockwise towards the door casting followed by the outer nut to tighten the latch back into place. Where extra clamping force is required a washer can be removed from the spindle stack. When new seals are fitted, the reverse may be necessary to allow for the extra thickness. Hinges have a limited amount of adjustment which is achieved by slackening the mounting screws and re-positioning before re-tightening the screws.
- 8.1.8 Replacing door seals:** Rope seals are fixed in place with stove seal adhesive. This is sometimes ceramic in formulation or high temperature silicone such as Heat Mate which is more flexible. NEVER use ordinary glazing or sanitary silicone adhesives. Simply pull away old seals, scrape off excess old adhesives. Apply new

adhesive continuously onto the mounting face and apply the new rope evenly all around. NOTE: Ensure NO gaps at the meeting ends of any continuous loops or butt joints and that the rope sits properly into corners. Close the stove door and leave to dry for several hours before firing. Seals can be tested by trapping a strip of paper and closing the door on it. If the paper is trapped then the seal is working. If the paper pulls out then something is wrong.

**8.1.9 Re-painting:** All matt black solid fuel stoves will require some re-painting from time to time. The stove can simply be re-painted by using stove spray paint or high temperature coatings after rubbing down with wire wool or similar abrasive to remove all loose debris from the surfaces.

**8.1.10 Re-assembly:** This is the reverse of the dismantling procedure – again taking particular care not to drop the firebox liners onto the cast iron grate as re-assembly takes place.

## 8.2 GO ECO 5kW Stove Principal Dimensions

All Dimensions shown in mm.

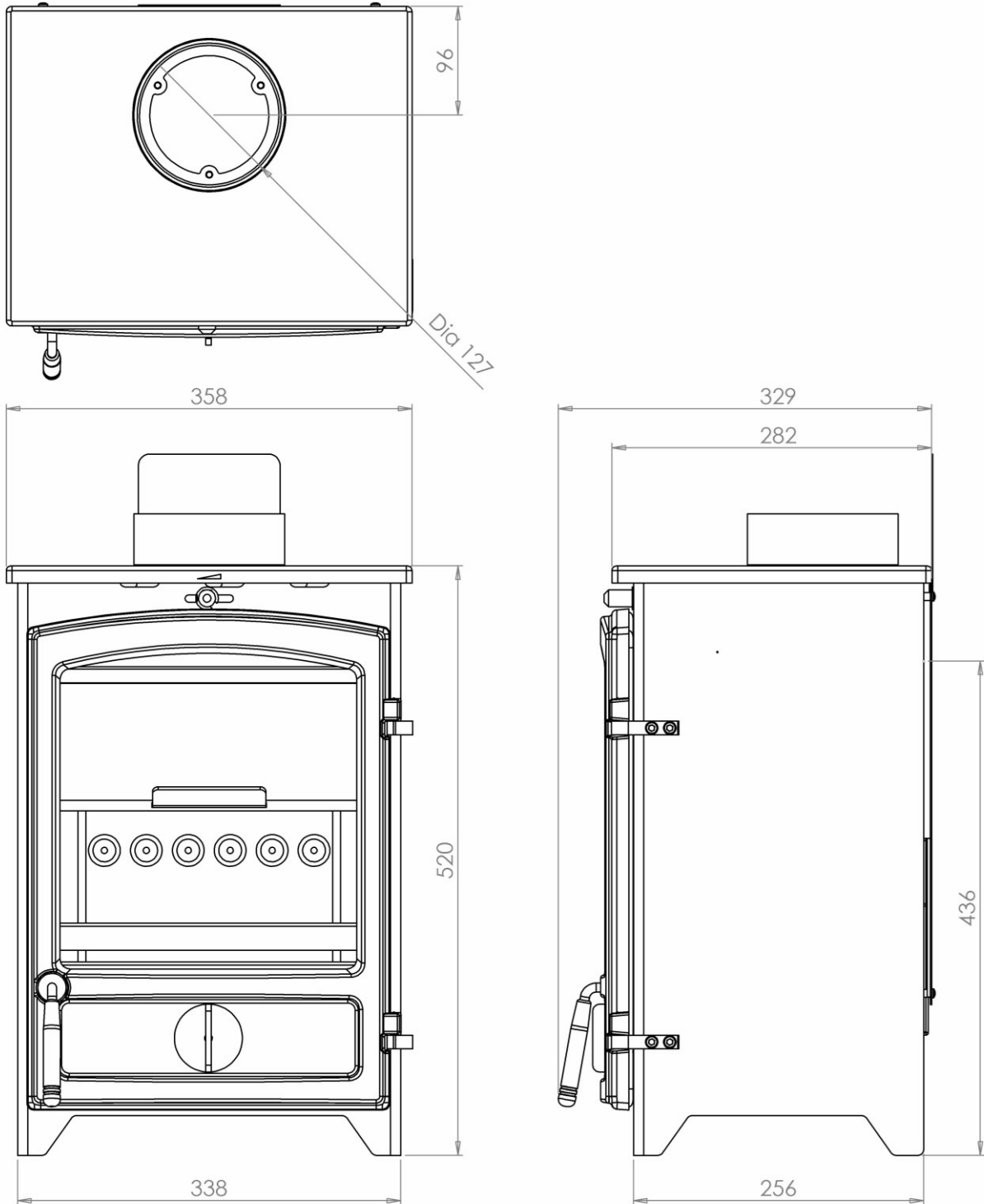

## 8.3 GO ECO 5kW WIDE Stove Principal Dimensions

All Dimensions shown in mm.

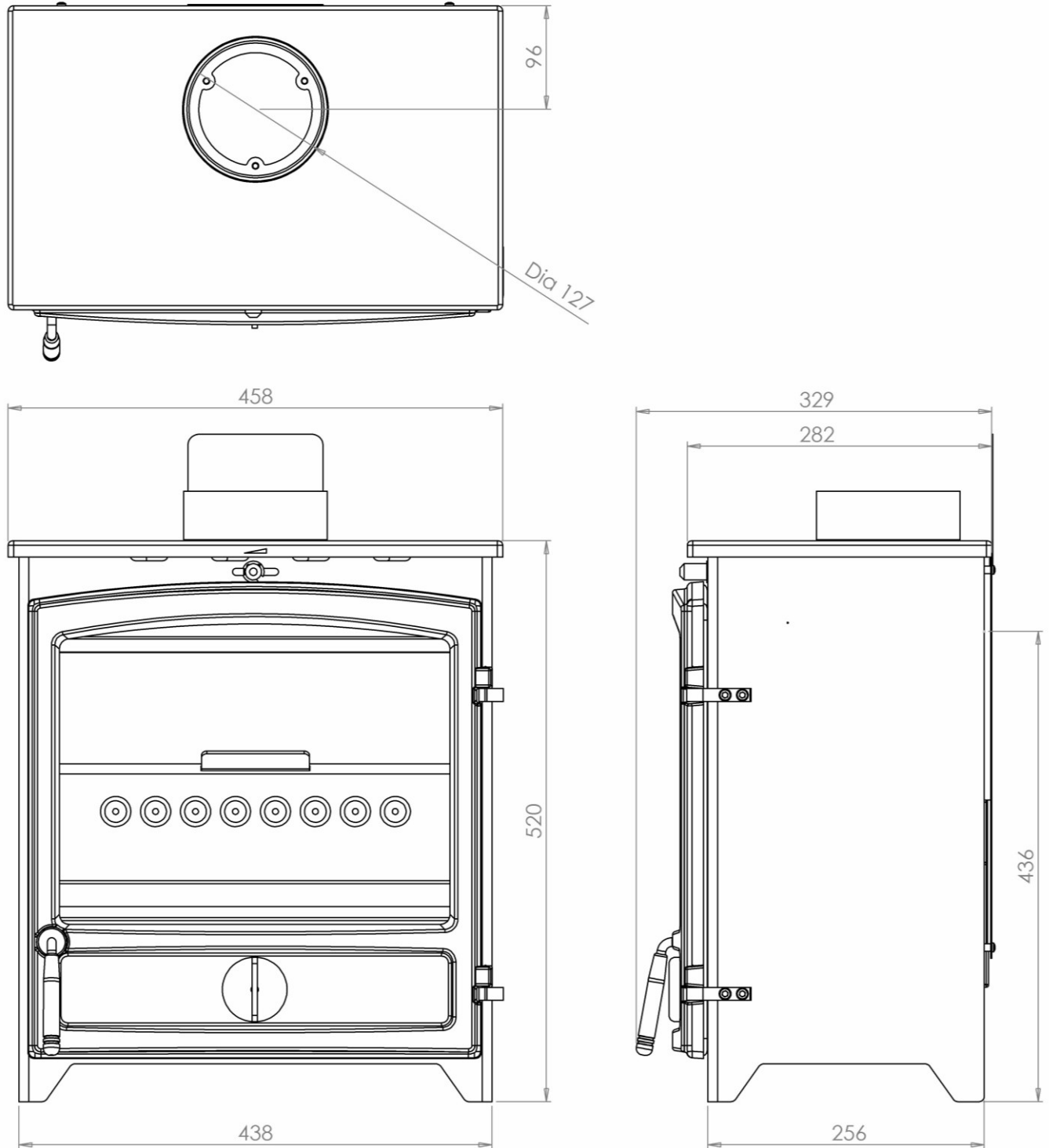

## **9.0 Frequently Asked Questions**

**1 Do stoves require a chimney or a liner?** All of our stoves require a suitable chimney or professionally installed flue system. A liner may or may not be required depending on flue conditions and only your installer can confirm. Our stoves do not mandatorily require a liner.

**2 How do I clean the chimney?** You will require a chimney sweep to clean the chimney. It is essential to provide a dedicated chimney cleaning access door when installing the flue of the stove in some situations. In many situations the chimney can be swept through the firebox.

**3 Who should install my stove?** Charlton & Jenrick want you to enjoy the maximum performance from your appliance. To ensure this, it is essential that they are installed correctly. We strongly recommend that your stove is installed by a suitably qualified installer e.g HETAS.

**4 How do I regulate the heat output?** Each stove has various air controls, which will allow you to easily regulate the heat output. Output can also be varied by log size and quantity fired.

**5 What warranty do I get?** Charlton & Jenrick will replace, free of charge, any part that fails (under normal operating conditions) within 12 months of purchase. Consumables such as glass, firebox lining boards or stove rope and adhesives are not guaranteed. We do not accept consequential or incidental liability claims from any product failure. **A call out charge will apply if our engineer attends any stove problem that is not related to product failure.**

**6 Where can I get spare parts?** Your local stove retailer will be pleased to supply spare parts and to provide any other information you require. Alternatively contact Charlton & Jenrick.

**7 Can the doors be left open while burning?** For safety and heat efficiency the doors should remain closed. These stoves are not designed or approved for doors open operation.

**8 Why is the stove smoking when lit?** A flue with lack of draught problems is almost certainly the cause of a smoking stove. Also check adequate ventilation is present – if opening a window or door stops the smoking then lack of ventilation is the probable main cause. A qualified fitter should complete both a smoke pressure and flow test prior to fitting the stove to ascertain the integrity of the flue.

**9 Why should I “Run in” my stove?** To begin, light a series of small fires over a period of a few days to allow the paint finish to cure. The stove is finished with a highly heat resistant paint. The finish can be renovated with stove paint available from your stove retailer. If the stove is not “run in” correctly, this may cause the paint to discolour and flake.

**10 What is Over Firing?** Over firing is overheating your stove by having the fire burning too fiercely. Your stove should never be used in a manner to cause over firing. Over firing can be caused by over loading the stove with fuel or leaving air controls fully open or operating the stove with leaking or defective door rope seals. If any part of stove glows red hot then your stove is over firing and your air control should be adjusted to reduce airflow to stove immediately. Over firing can cause permanent damage to the appliance, which is not covered by warranty.

---

### **Charlton & Jenrick Ltd**

Unit D Stafford Park 2, Telford, Shropshire, TF3 3AR

**T: 0845 519 5991**

**F: 0845 519 5992**

A Charlton and Jenrick Group Company